

TECHNICAL DATA



Reversing units RA

Blower/ reversing unit combination		Voltage	Current	Frequency	Switch-over time		Weight	Item No.
Model	Model	V	A	Hz	Reversing s	Impulse or neutral s	kg	
SD 24	RA 4	200-240	0,041	50/60	0,7	-	4,3	100513
SD 4n	RA 4 D	200-240	0,041	50/60	-	0,35	4,3	100696
SD 42	RAZ 4 S	200-240	0,041	50/60	-	0,35	4,3	100697
SD 400	RAZ 4	200-240	0,041	50/60	0,7	0,35	4,3	100651
SD 420	RAGZ 4	200-240	0,041	50/60	0,7	0,35	4,3	100376
	RA 4/1	200-240	0,041	50/60	0,7		4,2	100514
	RA 4/1 D	200-240	0,041	50/60	-	0,35	4,2	100698
	RA 4/1 S	200-240	0,041	50/60	-	0,35	4,2	100699
	RAZ 4/1	200-240	0,041	50/60	0,7	0,35	4,2	100652
	RAGZ 4/1	200-240	0,041	50/60	0,7	0,35	4,2	100378
SD 5	RA 6	200-240	0,041	50/60	0,7	-	5,9	100515
SD 52	RA 6 D	200-240	0,041	50/60	-	0,35	5,9	100700
SD 54	RA 6 S	200-240	0,041	50/60	-	0,35	5,9	100701
SD 540	RAZ 6	200-240	0,041	50/60	0,7	0,35	5,9	100653
SD 5200	RAGZ 6	200-240	0,041	50/60	0,7	0,35	5,9	100380
SD 5400								
SD 6	RA 6/1	200-240	0,041	50/60	0,7	-	5,7	100516
SD 62	RA 6/1 D	200-240	0,041	50/60	-	0,35	5,7	100702
SD 64	RA 6/1 S	200-240	0,041	50/60	-	0,35	5,7	100703
SD 600	RAZ 6/1	200-240	0,041	50/60	0,7	0,35	5,7	100654
	RAGZ 6/1	200-240	0,041	50/60	0,7	0,35	5,7	100441
SD 6200	RA 8	200-240	0,1	50/60	0,7	-	8,7	100585
SD 6400	RA 8 D	200-240	0,1	50/60	-	0,35	8,7	100704
SD 7	RA 8 S	200-240	0,1	50/60	-	0,35	8,7	100705
SD 72	RAZ 8	200-240	0,1	50/60	0,7	0,35	8,7	100706
SD 74	RAGZ 8	200-240	0,1	50/60	0,7	0,35	8,7	100385
SD 740								
SD 80	RA 8/1	200-240	0,1	50/60	0,7	-	8,3	100586
SD 8	RA 8/1 D	200-240	0,1	50/60	-	0,35	8,3	100707
SD 82	RA 8/1 S	200-240	0,1	50/60	-	0,35	8,3	100708
SD 800	RAZ 8/1	200-240	0,1	50/60	0,7	0,35	8,3	100709
SD 820	RAGZ 8/1	200-240	0,1	50/60	0,7	0,35	8,3	100386
SD 90	RA 9	200-240	0,33	50/60	0,7	-	11,4	101379
SD 9	RA 9 D	200-240	0,33	50/60	-	0,35	11,4	100009
SD 92	RA 9 S	200-240	0,33	50/60	-	0,35	11,4	100387
SD 900	RAZ 9	200-240	0,33	50/60	0,7	0,35	11,4	100381
	RAGZ 9	200-240	0,33	50/60	0,7	0,35	11,4	100382
	RA 9/1	200-240	0,33	50/60	0,7	-	11,1	100379
	RA 9/1 D	200-240	0,33	50/60	-	0,35	11,1	100010
	RA 9/1 S	200-240	0,33	50/60	-	0,35	11,1	100388
	RAZ 9/1	200-240	0,33	50/60	0,7	0,35	11,1	100383
	RAGZ 9/1	200-240	0,33	50/60	0,7	0,35	11,1	100384



TECHNICAL DATA

Reversing units

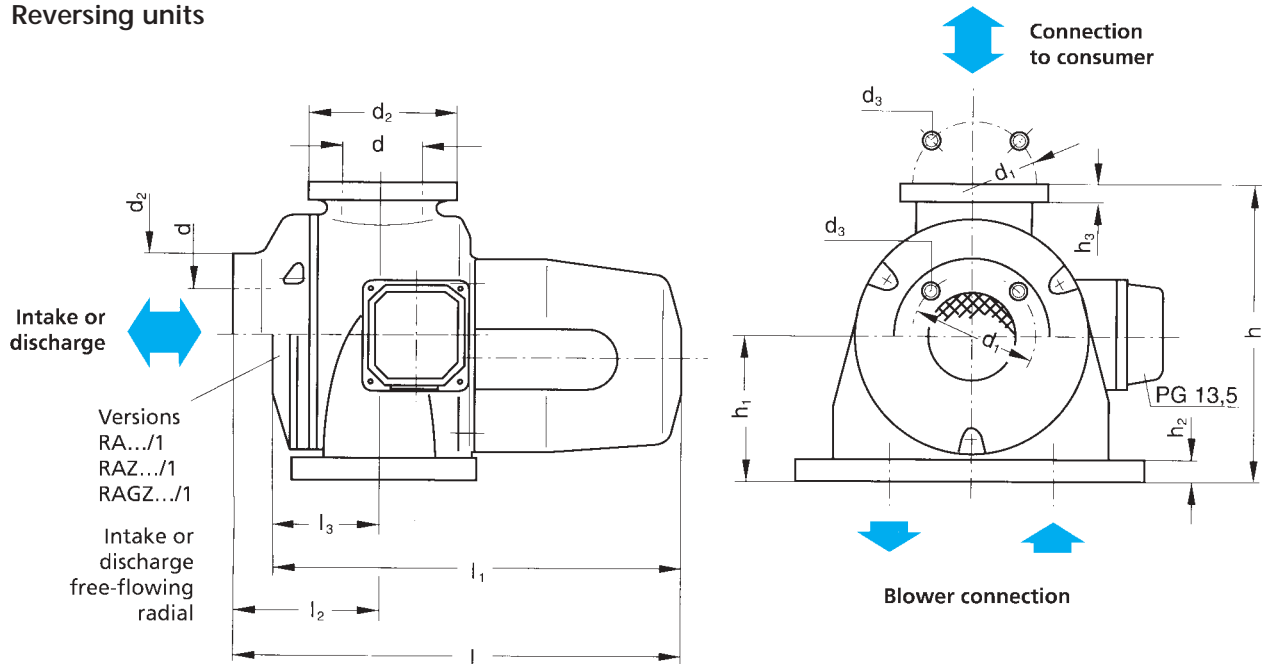

Model	l	l ₁	l ₂	l ₃	d	d ₁	d ₂	d ₃	h	h ₁	h ₂	h ₃
RA 4 bis RAGZ 4	267	-	80	-	45	68	80	M5	160	80	12	10
RA 4/1 bis RAGZ 4/1	-	245	-	58	45	68	80	M5	160	80	12	10
RA 6 bis RAGZ 6	294	-	95	-	55	85	100	M6	185	95	12	10
RA 6/1 bis RAGZ 6/1	-	270	-	71	55	85	100	M6	185	95	12	10
RA 8 bis RAGZ 8	372	-	104	-	65	110	130	M8	210	105	15	12
RA 8/1 bis RAGZ 8/1	-	348	-	80	65	110	130	M8	210	105	15	12
RA 9 bis RAGZ 9	405	-	120	-	80	118	145	M8	250	125	15	12
RA 9/1 bis RAGZ 9/1	-	375	-	90	80	118	145	M8	250	125	15	12

ACCESSORIES



Fein filters with connector

SD 12,
SE 12,
SD 12 B

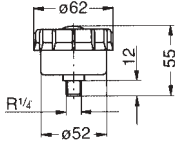

SD 20
SE 20
SD 22
SE 22

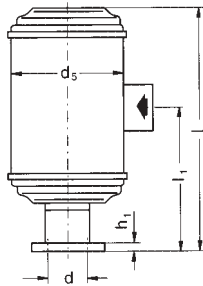
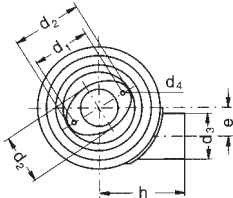

SD 2n –
SD 820

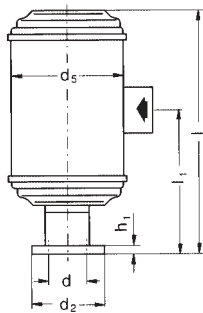
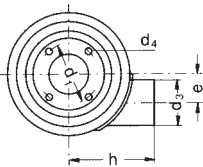

SD 90 –
SD 900
SD 120
SD 140

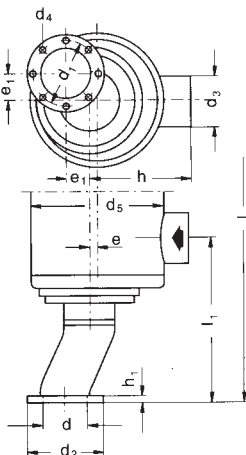

Model	l	l ₁	d	d ₁	d ₂	d ₃	d ₄	d ₅	e	e ₁	h	h ₁	Item No.
SD 12, SE 12 SD 12 B	Dimensions see illustration												001192
SD 20, SE 20	290	192	38	56	60/73	37	5,5	100	28	-	75	12	001506
SD 22, SE 22	290	192	37	58	50/70	37	5,5	100	28	-	75	12	001515
SD 2n, SE 2n SD 2n-1	231	130	38	58	70	37	5,5	100	28	-	75	6	000374
SD 3, SE 3 SD 3-1	251	153	24	48	60	37	5,5	100	28	-	75	6	000375
SD 24, SE 24 SD 4n, SE 4n SD 4n - 1 SD 42, SE 42 SD 400 SD 420	278	163	45	68	79	54	5,5	130	35	-	100	8	000377
SD 5, SE 5, SD 52, SD 54 SD 540, SD 5200 SD 5400	348	195	55	85	100	62	7	150	40	-	120	10	000379
SD 6, SD 6-1 SD 62, SD 64 SD 600													
SD 6200 SD 6400	442	277	65	110	130	82	9	190	50	-	150	12	000440
SD 7, SD 7-1 SD 72, SD 74 SD 740													
SD 80, SD 8 SD 8-1 SD 82 SD 800 SD 820													
SD 90, SD 9 SD 9-1 SD 92 SD 900	635	355	83	118	145	110	9	240	16	44	185	12	001267
SD 120 SD 140	778	493	100	139	165	132	9,5	270	16	51	210	8	007276

Space cartridge for fine filter

Model	Item No.
SD 12, SE 12	001261
SD 20, SE 20	000447
SD 22, SE 22	000447
SD 2n- SD 2n-1	000447
SD 3- SD 3-1	000447
SD 24- SD 420	000448
SD 5- SD 600	000449
SD 6200 - SD 820	000450
SD 90 - SD 900	001318
SD 120, SD 140	000516

ACCESSORIES



Intermediate tubes
necessary with fine filter
and excess pressure valve

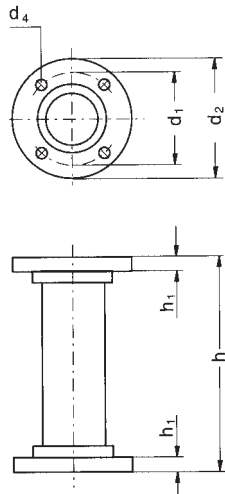

Model	d ₁	d ₂	d ₄	h	h ₁	Item No.
SD 2n, SE 2n SD 2n-1	-	-	-	-	-	-
SD 3, SE 3, SD 3-1	-	-	-	-	-	-
SD 24, SE 24	-	-	-	-	-	-
SD 4n, SE 4n SD 4n-1, SD 42 SE 42, SD 400 SD 420	68	79	6	140	10	001164
SD 5, SE 5, SD 52 SD 54, SD 540 SD 5200, SD 5400 SD 6, SD 6-1 SD 62, SD 64 SD 600	85	100	7	185	10	000345
SD 6200, SD 6400 SD 7, SD 7-1, SD 72 SD 74, SD 740 SD 80, SD 8, SD 8-1 SD 82, SD 800 SD 820	110	130	9	240	12	001163
SD 120, SD 140	139	165	9	270	30	000569

Throttle valve

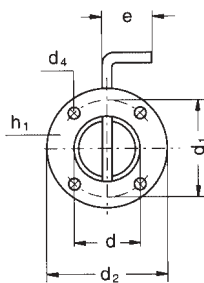

Model	d	d ₁	d ₂	d ₄	e	h ₁	Item No.
SD 20, SE 20	-	-	-	-	-	-	-
SD 22, SE 22	-	-	-	-	-	-	-
SD 2n, SE 2n SD 2n-1	38	58	70	6	34	12	000111
SD 3, SE 3, SD 3-1	24	48	60	6	34	12	000112
SD 24, SE 24, SD 4n SE 4n, SD 4n-1 SD 42, SE 42 SD 400, SE 420	45	68	79	6	34	12	000105
SD 5, SE 5, SD 52 SD 54, SD 540 SD 5200, SD 5400 SD 6, SD 6-1 SD 62, SD 64 SD 600	55	85	100	7	34	12	000373
SD 6200, SD 6400 SD 7, SD 7-1, SD 72 SD 74, SD 740 SD 80, SD 8, SD 8-1 SD 82, SD 800 SD 820	65	110	130	9	50	12	000559
SD 90, SD 9 SD 9-1, SD 92 SD 900	80	118	145	9	70	12	001271
SD 120, SD 140	98	139	165	9	100	23	000738



ACCESSORIES

Threaded flanges

SD 20
SE 20
SD 22
SE 22

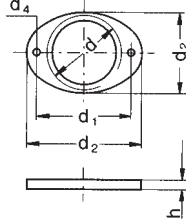

SD 2n –
SD 900
SD 120
SD 140

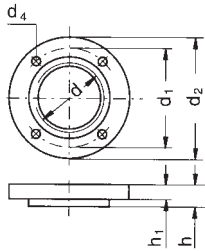

Model	d	d ₁	d ₂	d ₄	h	h ₁	Item No.
SD 20, SE 20	R1" x 12	56	60/73	5,5	12	-	001462
SD 22, SE 22	R1 1/4" x 12	58	50/70	5,5	12	-	001452
SD 2n, SE 2n SD 2n-1	R1 1/4" x 10	58	70	5,5	10	10	000109
SD 3, SE 3, SD 3-1	R3/4" x 10	48	60	5,5	10	10	000110
SD 24, SE 24, SD 4n SE 4n, SD 4n-1 SD 42, SE 42 SD 400, SE 420	R1 1/2" x 15	68	79	6	15	10	000103
SD 5, SE 5, SD 52 SD 54, SD 540 SD 5200, SD 5400 SD 6, SD 6-1 SD 62, SD 64 SD 600	R2" x 15	85	100	7	15	10	000372
SD 6200, SD 6400 SD 7, SD 7-1, SD 72 SD 74, SD 740 SD 80, SD 8, SD 8-1 SD 82, SD 800 SD 820	R2 1/2" x 20	110	130	9	20	12	000439
SD 90, SD 9 SD 9-1, SD 92 SD 900	R3" x 20	118	145	9	20	12	001272
SD 120, SD 140	R4" x 30	139	165	9	30	-	007376

Welding flanges

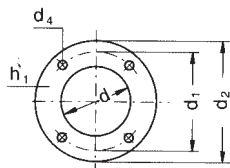

Model	d	d ₁	d ₂	d ₄	h ₁	Item No.
SD 20, SE 20	-	-	-	-	-	-
SD 22, SE 22	-	-	-	-	-	-
SD 2n, SE 2n SD 2n-1	38	58	70	5,5	10	000107
SD 3, SE 3, SD 3-1	24	48	60	5,5	10	000108
SD 24, SE 24, SD 4n SE 4n, SD 4n-1 SD 42, SE 42 SD 400, SE 420	49	68	79	5,5	10	000104
SD 5, SE 5, SD 52 SD 54, SD 540 SD 5200, SD 5400 SD 6, SD 6-1 SD 62, SD 64 SD 600	61	85	100	7	12	000371
SD 6200, SD 6400 SD 7, SD 7-1, SD 72 SD 74, SD 740 SD 80, SD 8, SD 8-1 SD 82, SD 800 SD 820	76,5	110	130	9	12	000656
SD 90, SD 9 SD 9-1, SD 92 SD 900	90	118	145	9	12	001273
SD 120, SD 140	115,5	139	165	9,5	12	008770

Dimensions in mm (subject to modifications)



ACCESSORIES

Silencers with connector

SD 22
SE 22

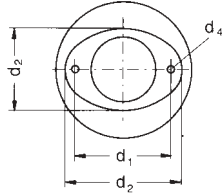

SD 2n –
SD 920
SD 120
SD 140

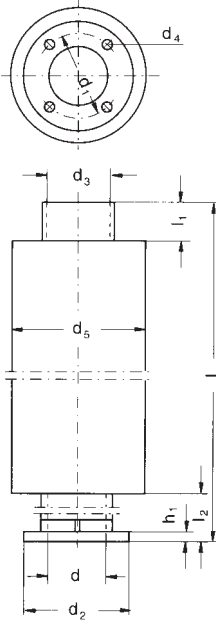

Model	l	l ₁	l ₂	d	d ₁	d ₂	d ₃	d ₄	d ₅	h ₁	Silencer Item No.	Connector Item No.
SD 20, SE 20	-	-	-	-	-	-	-	-	-	-	-	-
SD 22, SE 22	606	50	150	37	58	50/70	45	5,5	90	6	000826	001451
SD 2n, SE 2n SD 2n-1	606	50	150	38	58	70	45	5,5	90	6	000826	000114
SD 3, SE 3 SD 3-1	635	50	150	24	48	50	45	5,5	90	6	000826	004830
SD 24, SE 24 SD 4n, SE 4n SD 4n-1 SD 42, SE 42 SD 400, SD 420	608	50	150	45	68	79	55	5,5	100	8	000813	401276
SD 5, SE 5 SD 52, SD 54 SD 540, SD 5200 SD 5400	610	50	150	55	85	100	65	7	115	10	000605	400857
SD 6, SD 6-1 SD 62, SD 64 SD 600												
SD 6200 SD 6400 SD 7, SD 7-1 SD 72, SD 74 SD 740 SD 80, SD 8 SD 8-1, SD 82 SD 800, SD 820	612	50	150	65	110	130	80	9	120	12	000603	000438
SD 90, SD 9 SD 9-1, SD 92 SD 900	1012	50	162	80	118	145	97	9	150	12	004174	001270
SD 120, SD 140	1100	50	205	100	139	165	112	9,5	160	8	000751	000538

Pressure and vacuum relief valves

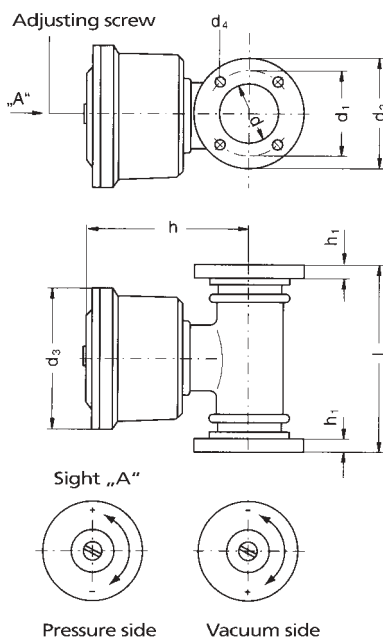

Model	l	d	d ₁	d ₂	d ₃	d ₄	h	h ₁	for use on vacuum side Item No.	for use on pressure side Item No.
SD 2n, SE 2n SD 2n-1	-	-	-	-	-	-	-	-	-	-
SD 3, SE 3, SD 3-1	-	-	-	-	-	-	-	-	-	-
SD 24, SE 24	-	-	-	-	-	-	-	-	-	-
SD 4n, SE 4n SD 4n-1, SD 42 SE 42, SD 400 SD 420	135	45	68	79	100	5,5	120	10	000592	000593
SD 5, SE 5, SD 52 SD 54, SD 540 SD 5200, SD 5400	180	53	85	100	125	7	150	10	000509	000510
SD 6, SD 6-1 SD 62, SD 64 SD 600										
SD 6200, SD 6400 SD 7, SD 7-1 SD 72, SD 74 SD 740	205	68	110	130	145	9	178	12	000662	000663
SD 80, SD 8 SD 8-1, SD 82									000442	000443
SD 800, SD 820									000662	000663
SD 90, SD 9 SD 9-1, SD 92 SD 900	225	80	118	145	180	9	188	12	001269	001268
SD 120, SD 140	248	108	139	165	180	9	202,5	30	000571	000572

Dimensions in mm (subject to modifications)

ACCESSORIES



Connectors

SD 12
SE 12
SD 12 B

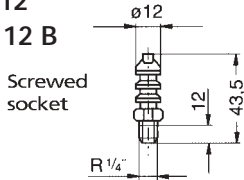

SD 20
SE 20
SD 22
SE 22

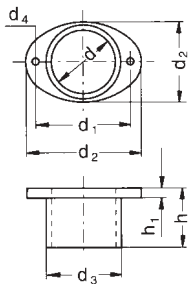

SD 2n –
SD 900
SD 120
SD 140

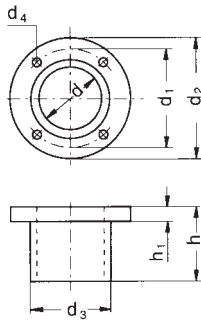

Model	d	d ₁	d ₂	d ₃	d ₄	h	h ₁	Item No.
SD 12, SE 12 SD 12 B	Dimensions see illustration							001193
SD 20, SE 20	30	56	60/73	41	5,5	35	6	000301
SD 22, SE 22	37	58	50/70	45	5,5	35	6	001451
SD 2n, SE 2n SD 2n-1	38	58	70	45	5,5	35	6	000114
SD 3, SE 3, SD 3-1	24	48	60	30	5,5	35	6	000115
SD 24, SE 24, SD 4n SE 4n, SD 4n-1 SD 42, SE 42 SD 400, SD 420	45	68	79	54	5,5	50	8	401276
SD 5, SE 5, SD 52 SD 54, SD 540 SD 5200, SD 5400 SD 6, SD 6-1, SD 62 SD 64, SD 600	55	85	100	65	7	50	10	400857
SD 6200, SD 6400 SD 7, SD 7-1, SD 72 SD 74, SD 740 SD 80, SD 8, SD 8-1 SD 82, SD 800 SD 820	65	110	130	80	9	60	12	000438
SD 90, SD 9, SD 9-1 SD 92, SD 900	81	118	145	97	9	60	12	001270
SD 120, SD 140	94	139	165	100	9	100	6	007716

Wire mesh guards

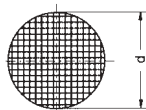

Model	d	Mash width 0,32 Item No.	Mash width 8 Item No.
SD 20, SE 20	33	008687	008688
SD 22, SE 22	40	008689	008690
SD 2n, SE 2n SD 2n-1, SD 3 SE 3, SD 3-1	70	000460	000464
SD 24, SE 24 SD 4n, SD 4n-1 SD 42, SE 42 SD 400, SD 420	85	000461	000465
SD 5, SE 5, SD 52 SD 54, SD 540 SD 5200, SD 5400 SD 6, SD 6-1, SD 62 SD 64, SD 600	113	000462	000466
SD 6200, SD 6400 SD 7, SD 7-1, SD 72 SD 74, SD 740 SD 80, SD 8, SD 8-1 SD 82, SD 800 SD 820	133	000463	000467
SD 90, SD 9, SD 9-1 SD 92, SD 900	148	001319	001320
SD 120, SD 140	155	000575	000577