



## **BHTS ZZ 280°**

### **Ball Bearings for High Temperature**

The BHTS ZZ 280° ball bearings are designed on the dimensions of a standard bearing but with treatments of stabilisation, surface treatment, radial clearance, grease and special shield that make them suitable for operation from -30° to +280°. Their recommended range of application is between 200° and 280° where these bearings achieve their best performance. Below 200° there are the BHTS ZZ C4 200° bearings available, which are cheaper and also allow a much higher rotational speed. The BHTS ZZ 280° bearings are currently available in approximately 400 different models, all of which are in stock and able to cover most of the requirements for bearings of high temperatures.

#### **Technical characteristics:**

Material Steel AISI 52100 (Chrome) stabilized to the application

Treatment of manganese phosphate coating on all steel parts

Radial Clearance 4xC5

Shield ZZ

Greasing with PTFE based on silicone free grease for temperatures up to 280°  
(with a drop point above 400°)

#### **Fields of application:**

Paint Ovens

Steel Industry

Furnaces for Ceramic Industry

Trolley Industry, Brick Kilns



## BHTS ZZ 280° (MICRO Serie)

### Ball Bearings for High Temperature

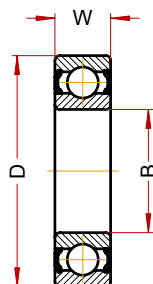
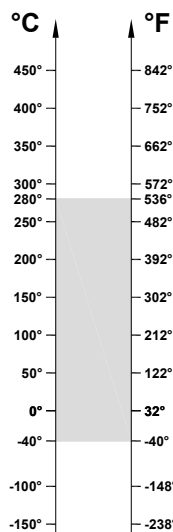

OPERATING RANGE: -40° / 280°C

ECONOMIC OPERATING RANGE: 200° / 280°C

Designation	Bore (B)	Diam (D)	Widht (W)	Weight g	Speed RPM/min (*)	Static Load, kN at 280°	Static Load, kN at 20°
613/3 BHTS ZZ 280°	3	8	3	1.5	2300	0,11	0,16
623 BHTS ZZ 280°	3	10	4	3	2300	0,13	0,18
604 BHTS ZZ 280°	4	12	4	3	2300	0,24	0,34
624 BHTS ZZ 280°	4	13	5	3	2300	0,24	0,34
605 BHTS ZZ 280°	5	14	5	4	2300	0,30	0,42
625 BHTS ZZ 280°	5	16	5	5	2300	0,30	0,42
606 BHTS ZZ 280°	6	17	6	7	2300	0,60	0,85
626 BHTS ZZ 280°	6	19	6	8	2300	0,60	0,85
607 BHTS ZZ 280°	7	19	6	8	2300	0,60	0,85
627 BHTS ZZ 280°	7	22	7	13	2200	0,79	1,10
608 BHTS ZZ 280°	8	22	7	13	2100	0,79	1,10
628 BHTS ZZ 280°	8	24	8	14	2000	0,79	1,10
609 BHTS ZZ 280°	9	24	7	15	1900	0,93	1,30
629 BHTS ZZ 280°	9	26	8	20	1800	1,12	1,57

**OPERATING RANGE** is the correct technical range in which can be used the bearing with good operating result.

**ECONOMIC OPERATING RANGE** is the range of temperature in which you can find, according to our study experience and know-how, the better relation price - quality life-time.

## BHTS ZZ 280° (61800 Serie)

### Ball Bearings for High Temperature

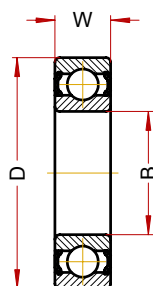
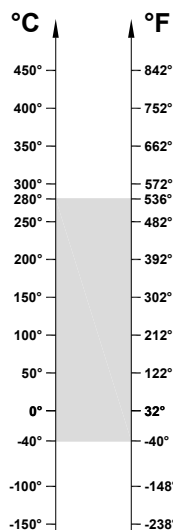

OPERATING RANGE: -40° / 280°C

ECONOMIC OPERATING RANGE: 200° / 280°C

Designation	Bore (B)	Diam (D)	Widht (W)	Weight g	Speed RPM/min (*)	Static Load, kN at 280°	Static Load, kN at 20°
61800 BHTS ZZ 280°	10	19	5	5.6	2240	0,38	0,53
61801 BHTS ZZ 280°	12	21	5	6.5	2080	0,68	0,95
61802 BHTS ZZ 280°	15	24	5	7.6	1920	0,89	1,25
61803 BHTS ZZ 280°	17	26	5	8.2	1760	1,04	1,45
61804 BHTS ZZ 280°	20	32	7	18	1600	1,60	2,24
61805 BHTS ZZ 280°	25	37	7	24	1360	2	2,8
61806 BHTS ZZ 280°	30	42	7	27	1040	2,39	3,35
61807 BHTS ZZ 280°	35	47	7	32	880	2,57	3,6
61808 BHTS ZZ 280°	40	52	7	35	800	3,04	4,25
61809 BHTS ZZ 280°	45	58	7	42	720	4	5,6
61810 BHTS ZZ 280°	50	65	7	52	680	4,50	6,3
61811 BHTS ZZ 280°	55	72	9	81	600	6,07	8,5
61812 BHTS ZZ 280°	60	78	10	105	560	7,86	11
61813 BHTS ZZ 280°	65	85	10	124	504	8,57	12
61814 BHTS ZZ 280°	70	90	10	133	480	8,93	12,5
61815 BHTS ZZ 280°	75	95	10	143	448	9,57	13,4

**OPERATING RANGE** is the correct technical range in which can be used the bearing with good operating result.

**ECONOMIC OPERATING RANGE** is the range of temperature in which you can find, according to our study experience and know-how, the better relation price - quality life-time.

## BHTS ZZ 280° (61900 Serie)

### Ball Bearings for High Temperature

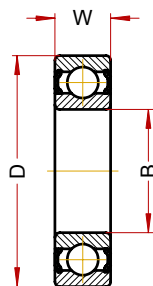
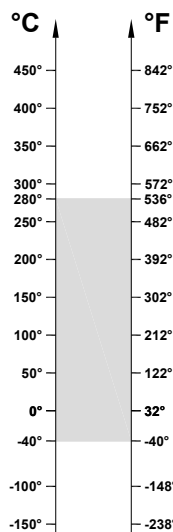

OPERATING RANGE: -40° / 280°C

ECONOMIC OPERATING RANGE: 200° / 280°C

Designation	Bore (B)	Diam (D)	Widht (W)	Weight g	Speed RPM/min (*)	Static Load, kN at 280°	Static Load, kN at 20°
61900 BHTS ZZ 280°	10	22	6	10	2240	0,54	0,75
61901 BHTS ZZ 280°	12	24	6	11	2080	0,69	0,97
61902 BHTS ZZ 280°	15	28	7	16	1920	1,45	2,03
61903 BHTS ZZ 280°	17	30	7	18	1760	1,64	2,3
61904 BHTS ZZ 280°	20	37	9	38	1600	2,57	3,6
61905 BHTS ZZ 280°	25	37	7	22	1360	2,86	4
61906 BHTS ZZ 280°	30	47	9	51	1040	3,23	4,52
61907 BHTS ZZ 280°	35	55	10	80	880	4,43	6,2
61908 BHTS ZZ 280°	40	62	12	120	800	6,64	9,3
61909 BHTS ZZ 280°	45	68	12	140	720	7	9,8
61910 BHTS ZZ 280°	50	72	12	160	680	7,43	10,4
61911 BHTS ZZ 280°	55	80	13	190	600	8,14	11,4
61912 BHTS ZZ 280°	60	85	13	200	560	8,57	12
61913 BHTS ZZ 280°	65	90	13	220	504	9,57	13,4
61914 BHTS ZZ 280°	70	100	16	350	480	13,07	18,3
61915 BHTS ZZ 280°	75	105	16	370	448	13,79	19,3

**OPERATING RANGE** is the correct technical range in which can be used the bearing with good operating result.

**ECONOMIC OPERATING RANGE** is the range of temperature in which you can find, according to our study experience and know-how, the better relation price - quality life-time.

## BHTS ZZ 280° (6000 Serie)

### Ball Bearings for High Temperature

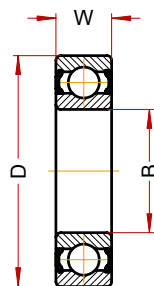
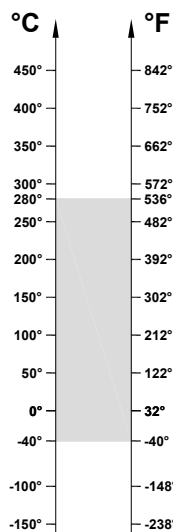

OPERATING RANGE: -40° / 280°C

ECONOMIC OPERATING RANGE: 200° / 280°C

Designation	Bore (B)	Diam (D)	Width (W)	Weight g	Speed RPM/min (*)	Static Load, kN at 280°	Static Load, kN at 20°
6000 BHTS ZZ 280°	10	26	8	20	2240	1,40	1,96
6001 BHTS ZZ 280°	12	28	8	25	2080	1,69	2,36
6002 BHTS ZZ 280°	15	32	9	30	1920	2,04	2,85
6003 BHTS ZZ 280°	17	35	10	40	1760	2,32	3,25
6004 BHTS ZZ 280°	20	42	12	69	1600	3,57	5
6005 BHTS ZZ 280°	25	47	12	80	1360	4,18	5,85
6006 BHTS ZZ 280°	30	55	13	120	1040	5,71	8
6007 BHTS ZZ 280°	35	62	14	160	880	7,43	10,4
6008 BHTS ZZ 280°	40	68	15	190	800	8,43	11,8
6009 BHTS ZZ 280°	45	75	16	250	720	10,21	14,3
6010 BHTS ZZ 280°	50	80	16	260	680	11,14	15,6
6011 BHTS ZZ 280°	55	90	18	390	600	15,14	21,2
6012 BHTS ZZ 280°	60	95	18	420	560	16,57	23,2
6013 BHTS ZZ 280°	65	100	18	440	504	17,86	25
6014 BHTS ZZ 280°	70	110	20	600	480	22,50	31,5
6015 BHTS ZZ 280°	75	115	20	640	448	24,29	34
6016 BHTS ZZ 280°	80	125	22	850	400	28,57	40
6017 BHTS ZZ 280°	85	130	22	890	380	30,64	42,9
6018 BHTS ZZ 280°	90	140	24	1150	360	35,64	49,9
6019 BHTS ZZ 280°	95	145	24	1200	340	38,54	53,95
6020 BHTS ZZ 280°	100	150	24	1250	300	38,54	53,95

**OPERATING RANGE** is the correct technical range in which can be used the bearing with good operating result.

**ECONOMIC OPERATING RANGE** is the range of temperature in which you can find, according to our study experience and know-how, the better relation price - quality life-time.

## BHTS ZZ 280° (6200 Serie)

### Ball Bearings for High Temperature

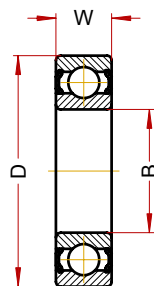
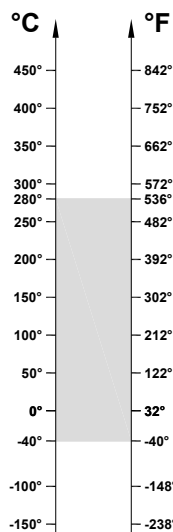

OPERATING RANGE: -40° / 280°C

ECONOMIC OPERATING RANGE: 200° / 280°C

Designation	Bore (B)	Diam (D)	Widht (W)	Weight g	Speed RPM/min (*)	Static Load, kN at 280°	Static Load, kN at 20°
6200 BHTS ZZ 280°	10	30	9	30	2080	1,86	2,6
6201 BHTS ZZ 280°	12	32	10	37	1920	2,21	3,1
6202 BHTS ZZ 280°	15	35	11	45	1600	2,68	3,75
6203 BHTS ZZ 280°	17	40	12	65	1440	3,39	4,75
6204 BHTS ZZ 280°	20	47	14	110	1200	4,68	6,55
6205 BHTS ZZ 280°	25	52	15	130	1120	5,71	8
6206 BHTS ZZ 280°	30	62	16	200	880	8	11,2
6207 BHTS ZZ 280°	35	72	17	290	760	10,92	15,3
6208 BHTS ZZ 280°	40	80	18	370	680	12,86	18
6209 BHTS ZZ 280°	45	85	19	410	640	14,57	20,4
6210 BHTS ZZ 280°	50	90	20	460	600	17,14	24
6211 BHTS ZZ 280°	55	100	21	610	536	20,71	29
6212 BHTS ZZ 280°	60	110	22	780	480	25,71	36
6213 BHTS ZZ 280°	65	120	23	990	424	29,64	41,5
6214 BHTS ZZ 280°	70	125	24	1040	400	31,43	44
6215 BHTS ZZ 280°	75	130	25	1210	384	35	49
6216 BHTS ZZ 280°	80	140	26	1400	350	39,29	55
6217 BHTS ZZ 280°	85	150	28	1800	330	45,71	64
6218 BHTS ZZ 280°	90	160	30	2150	310	52,5	73,5
6219 BHTS ZZ 280°	95	170	32	2600	300	58,21	81,5
6220 BHTS ZZ 280°	100	180	34	3150	290	66,43	93

**OPERATING RANGE** is the correct technical range in which can be used the bearing with good operating result.

**ECONOMIC OPERATING RANGE** is the range of temperature in which you can find, according to our study experience and know-how, the better relation price - quality life-time.

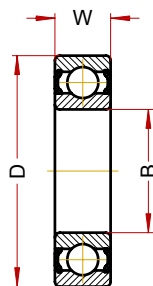
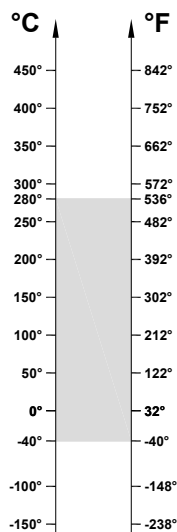
**BHTS ZZ 280° (6300 Serie)****Ball Bearings for High Temperature**

OPERATING RANGE: -40° / 280°C

ECONOMIC OPERATING RANGE: 200° / 280°C

Designation	Bore (B)	Diam (D)	Width (W)	Weight g	Speed RPM/min (*)	Static Load, kN at 280°	Static Load, kN at 20°
6300 BHTS ZZ 280°	10	35	11	52	1760	2,46	3,45
6301 BHTS ZZ 280°	12	37	12	60	1600	2,96	4,15
6302 BHTS ZZ 280°	15	42	13	80	1440	3,86	5,4
6303 BHTS ZZ 280°	17	47	14	120	1280	4,68	6,55
6304 BHTS ZZ 280°	20	52	15	140	1120	6,07	8,5
6305 BHTS ZZ 280°	25	62	17	225	880	8,14	11,4
6306 BHTS ZZ 280°	30	72	19	350	760	11,64	16,3
6307 BHTS ZZ 280°	35	80	21	450	680	13,57	19
6308 BHTS ZZ 280°	40	90	23	620	600	17,86	25
6309 BHTS ZZ 280°	45	100	25	830	536	22,86	32
6310 BHTS ZZ 280°	50	110	27	1050	480	27,14	38
6311 BHTS ZZ 280°	55	120	29	1350	424	33,93	47,5
6312 BHTS ZZ 280°	60	130	31	1700	400	37,14	52
6313 BHTS ZZ 280°	65	140	33	2100	360	42,86	60
6314 BHTS ZZ 280°	70	150	35	2500	344	48,57	68
6315 BHTS ZZ 280°	75	160	37	3000	320	54,64	76,5
6316 BHTS ZZ 280°	80	170	39	3600	300	61,79	86,5
6317 BHTS ZZ 280°	85	180	41	4250	290	68,92	96,5
6318 BHTS ZZ 280°	90	190	43	4900	270	77,14	108
6319 BHTS ZZ 280°	95	200	45	5650	250	84,29	118
6320 BHTS ZZ 280°	100	215	47	7000	230	100	140

**OPERATING RANGE** is the correct technical range in which can be used the bearing with good operating result.

**ECONOMIC OPERATING RANGE** is the range of temperature in which you can find, according to our study experience and know-how, the better relation price - quality life-time.

## BHTS ZZ 280° (UC Serie)

### Insert Bearings for High Temperature

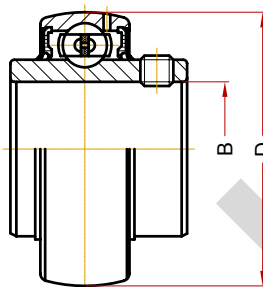
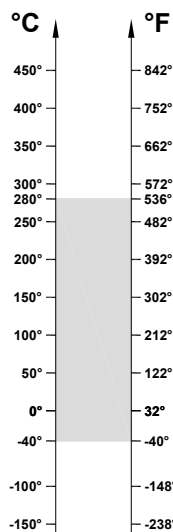

OPERATING RANGE: -40° / 280°C

ECONOMIC OPERATING RANGE: 200° / 280°C

Designation	Bore (B)	Diam (D)	Speed RPM/min (*)	Static Load, kN at 280°	Static Load, kN at 20°
UC 201 BHTS ZZ 280°	12	47	1440	4,72	6,6
UC 202 BHTS ZZ 280°	15	47	1440	4,72	6,6
UC 203 BHTS ZZ 280°	17	47	1440	4,72	6,6
UC 204 BHTS ZZ 280°	20	47	1200	4,72	6,6
UC 205 BHTS ZZ 280°	25	52	1120	5,58	7,8
UC 206 BHTS ZZ 280°	30	62	880	8	11,2
UC 207 BHTS ZZ 280°	35	72	760	10,79	15,1
UC 208 BHTS ZZ 280°	40	80	680	13	18,2
UC 209 BHTS ZZ 280°	45	85	640	14,72	20,6
UC 210 BHTS ZZ 280°	50	90	600	16,5	23,1
UC 211 BHTS ZZ 280°	55	100	536	20,7	29
UC 212 BHTS ZZ 280°	60	110	480	25,3	32,6
UC 213 BHTS ZZ 280°	65	120	424	28,4	39,8
UC 214 BHTS ZZ 280°	70	125	400	31,9	44,7
UC 215 BHTS ZZ 280°	75	130	384	35,15	49,2

**OPERATING RANGE** is the correct technical range in which can be used the bearing with good operating result.

**ECONOMIC OPERATING RANGE** is the range of temperature in which you can find, according to our study experience and know-how, the better relation price - quality life-time.

## BHTS ZZ 280° (UCPA Serie)

### Pillow Block for High Temperature

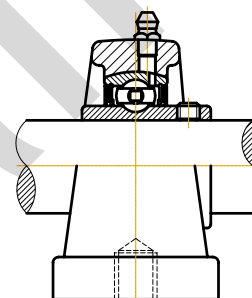
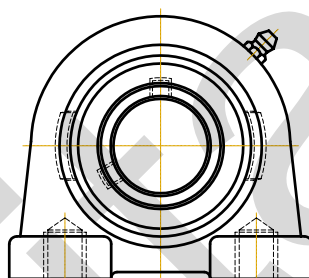
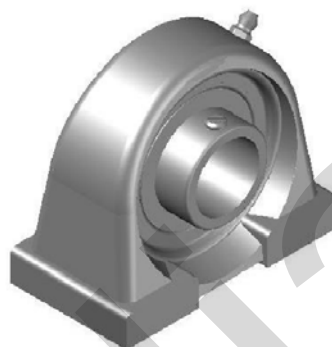
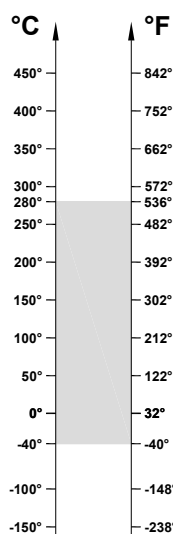

OPERATING RANGE: -40° / 280°C

ECONOMIC OPERATING RANGE: 200° / 280°C

Unit code	Bearing code	Housing code
UCPA 201 BHTS ZZ 280°	UC 201 BHTS ZZ 280°	SS PA 201
UCPA 202 BHTS ZZ 280°	UC 202 BHTS ZZ 280°	SS PA 202
UCPA 203 BHTS ZZ 280°	UC 203 BHTS ZZ 280°	SS PA 203
UCPA 204 BHTS ZZ 280°	UC 204 BHTS ZZ 280°	SS PA 204
UCPA 205 BHTS ZZ 280°	UC 205 BHTS ZZ 280°	SS PA 205
UCPA 206 BHTS ZZ 280°	UC 206 BHTS ZZ 280°	SS PA 206
UCPA 207 BHTS ZZ 280°	UC 207 BHTS ZZ 280°	SS PA 207
UCPA 208 BHTS ZZ 280°	UC 208 BHTS ZZ 280°	SS PA 208
UCPA 209 BHTS ZZ 280°	UC 209 BHTS ZZ 280°	SS PA 209
UCPA 210 BHTS ZZ 280°	UC 210 BHTS ZZ 280°	SS PA 210
UCPA 211 BHTS ZZ 280°	UC 211 BHTS ZZ 280°	SS PA 211
UCPA 212 BHTS ZZ 280°	UC 212 BHTS ZZ 280°	SS PA 212
UCPA 213 BHTS ZZ 280°	UC 213 BHTS ZZ 280°	SS PA 213
UCPA 214 BHTS ZZ 280°	UC 214 BHTS ZZ 280°	SS PA 214
UCPA 215 BHTS ZZ 280°	UC 215 BHTS ZZ 280°	SS PA 215

**OPERATING RANGE** is the correct technical range in which can be used the bearing with good operating result.

**ECONOMIC OPERATING RANGE** is the range of temperature in which you can find, according to our study experience and know-how, the better relation price - quality life-time.

## BHTS ZZ 280° (UCF Serie)

### Pillow Block for High Temperature

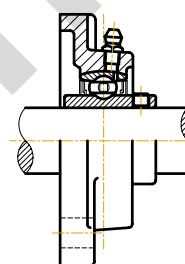
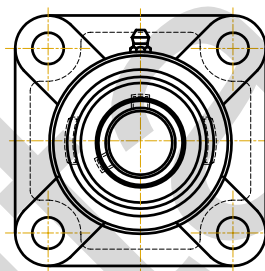
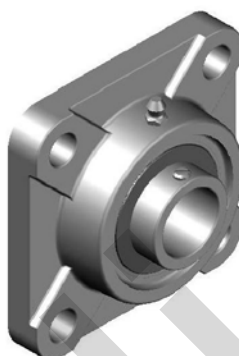
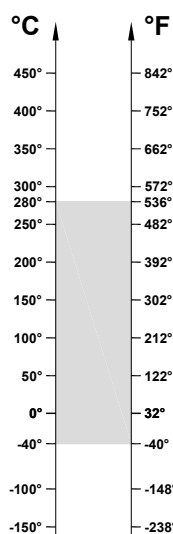

OPERATING RANGE: -40° / 280°C

ECONOMIC OPERATING RANGE: 200° / 280°C

Unit code	Bearing code	Housing code
UCF 201 BHTS ZZ 280°	UC 201 BHTS ZZ 280°	SS F 201
UCF 202 BHTS ZZ 280°	UC 202 BHTS ZZ 280°	SS F 202
UCF 203 BHTS ZZ 280°	UC 203 BHTS ZZ 280°	SS F 203
UCF 204 BHTS ZZ 280°	UC 204 BHTS ZZ 280°	SS F 204
UCF 205 BHTS ZZ 280°	UC 205 BHTS ZZ 280°	SS F 205
UCF 206 BHTS ZZ 280°	UC 206 BHTS ZZ 280°	SS F 206
UCF 207 BHTS ZZ 280°	UC 207 BHTS ZZ 280°	SS F 207
UCF 208 BHTS ZZ 280°	UC 208 BHTS ZZ 280°	SS F 208
UCF 209 BHTS ZZ 280°	UC 209 BHTS ZZ 280°	SS F 209
UCF 210 BHTS ZZ 280°	UC 210 BHTS ZZ 280°	SS F 210
UCF 211 BHTS ZZ 280°	UC 211 BHTS ZZ 280°	SS F 211
UCF 212 BHTS ZZ 280°	UC 212 BHTS ZZ 280°	SS F 212
UCF 213 BHTS ZZ 280°	UC 213 BHTS ZZ 280°	SS F 213
UCF 214 BHTS ZZ 280°	UC 214 BHTS ZZ 280°	SS F 214
UCF 215 BHTS ZZ 280°	UC 215 BHTS ZZ 280°	SS F 215

**OPERATING RANGE** is the correct technical range in which can be used the bearing with good operating result.

**ECONOMIC OPERATING RANGE** is the range of temperature in which you can find, according to our study experience and know-how, the better relation price - quality life-time.

## BHTS ZZ 280° (UCFL Serie)

### Pillow Block for High Temperature

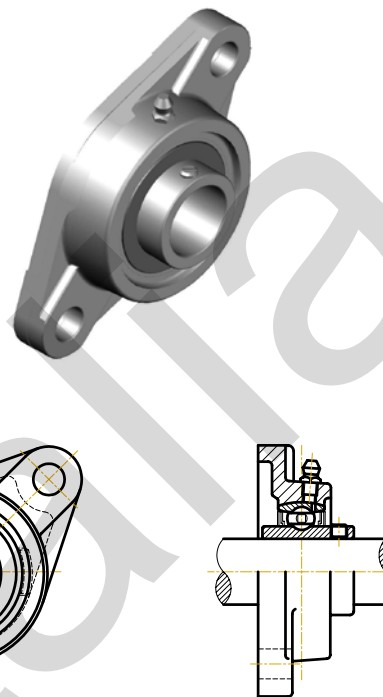
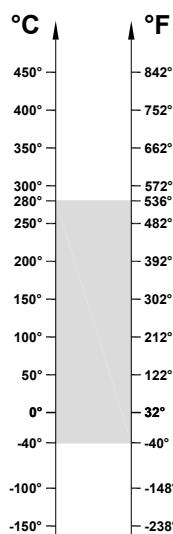

OPERATING RANGE: -40° / 280°C

ECONOMIC OPERATING RANGE: 200° / 280°C

Unit code	Bearing code	Housing code
UCFL 201 BHTS ZZ 280°	UC 201 BHTS ZZ 280°	SS FL 201
UCFL 202 BHTS ZZ 280°	UC 202 BHTS ZZ 280°	SS FL 202
UCFL 203 BHTS ZZ 280°	UC 203 BHTS ZZ 280°	SS FL 203
UCFL 204 BHTS ZZ 280°	UC 204 BHTS ZZ 280°	SS FL 204
UCFL 205 BHTS ZZ 280°	UC 205 BHTS ZZ 280°	SS FL 205
UCFL 206 BHTS ZZ 280°	UC 206 BHTS ZZ 280°	SS FL 206
UCFL 207 BHTS ZZ 280°	UC 207 BHTS ZZ 280°	SS FL 207
UCFL 208 BHTS ZZ 280°	UC 208 BHTS ZZ 280°	SS FL 208
UCFL 209 BHTS ZZ 280°	UC 209 BHTS ZZ 280°	SS FL 209
UCFL 210 BHTS ZZ 280°	UC 210 BHTS ZZ 280°	SS FL 210
UCFL 211 BHTS ZZ 280°	UC 211 BHTS ZZ 280°	SS FL 211
UCFL 212 BHTS ZZ 280°	UC 212 BHTS ZZ 280°	SS FL 212
UCFL 213 BHTS ZZ 280°	UC 213 BHTS ZZ 280°	SS FL 213
UCFL 214 BHTS ZZ 280°	UC 214 BHTS ZZ 280°	SS FL 214
UCFL 215 BHTS ZZ 280°	UC 215 BHTS ZZ 280°	SS FL 215

**OPERATING RANGE** is the correct technical range in which can be used the bearing with good operating result.

**ECONOMIC OPERATING RANGE** is the range of temperature in which you can find, according to our study experience and know-how, the better relation price - quality life-time.

## BHTS ZZ 280° (UCP Serie)

### Pillow Block for High Temperature

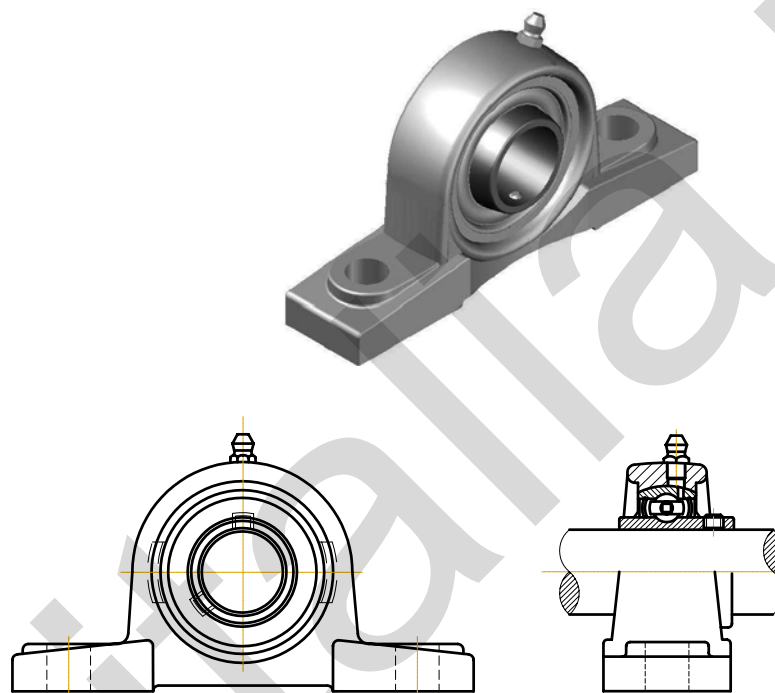
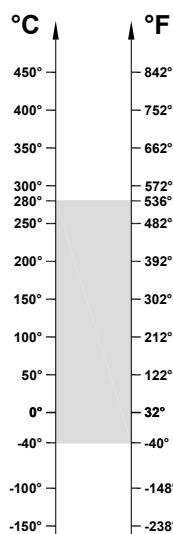

OPERATING RANGE: -40° / 280°C

ECONOMIC OPERATING RANGE: 200° / 280°C

Unit code	Bearing code	Housing code
UCP 201 BHTS ZZ 280°	UC 201 BHTS ZZ 280°	SS P 201
UCP 202 BHTS ZZ 280°	UC 202 BHTS ZZ 280°	SS P 202
UCP 203 BHTS ZZ 280°	UC 203 BHTS ZZ 280°	SS P 203
UCP 204 BHTS ZZ 280°	UC 204 BHTS ZZ 280°	SS P 204
UCP 205 BHTS ZZ 280°	UC 205 BHTS ZZ 280°	SS P 205
UCP 206 BHTS ZZ 280°	UC 206 BHTS ZZ 280°	SS P 206
UCP 207 BHTS ZZ 280°	UC 207 BHTS ZZ 280°	SS P 207
UCP 208 BHTS ZZ 280°	UC 208 BHTS ZZ 280°	SS P 208
UCP 209 BHTS ZZ 280°	UC 209 BHTS ZZ 280°	SS P 209
UCP 210 BHTS ZZ 280°	UC 210 BHTS ZZ 280°	SS P 210
UCP 211 BHTS ZZ 280°	UC 211 BHTS ZZ 280°	SS P 211
UCP 212 BHTS ZZ 280°	UC 212 BHTS ZZ 280°	SS P 212
UCP 213 BHTS ZZ 280°	UC 213 BHTS ZZ 280°	SS P 213
UCP 214 BHTS ZZ 280°	UC 214 BHTS ZZ 280°	SS P 214
UCP 215 BHTS ZZ 280°	UC 215 BHTS ZZ 280°	SS P 215

**OPERATING RANGE** is the correct technical range in which can be used the bearing with good operating result.

**ECONOMIC OPERATING RANGE** is the range of temperature in which you can find, according to our study experience and know-how, the better relation price - quality life-time.