

Spherical roller bearings

Mounting instructions for SKF sealed spherical roller bearings on an adapter sleeve – using the angle method

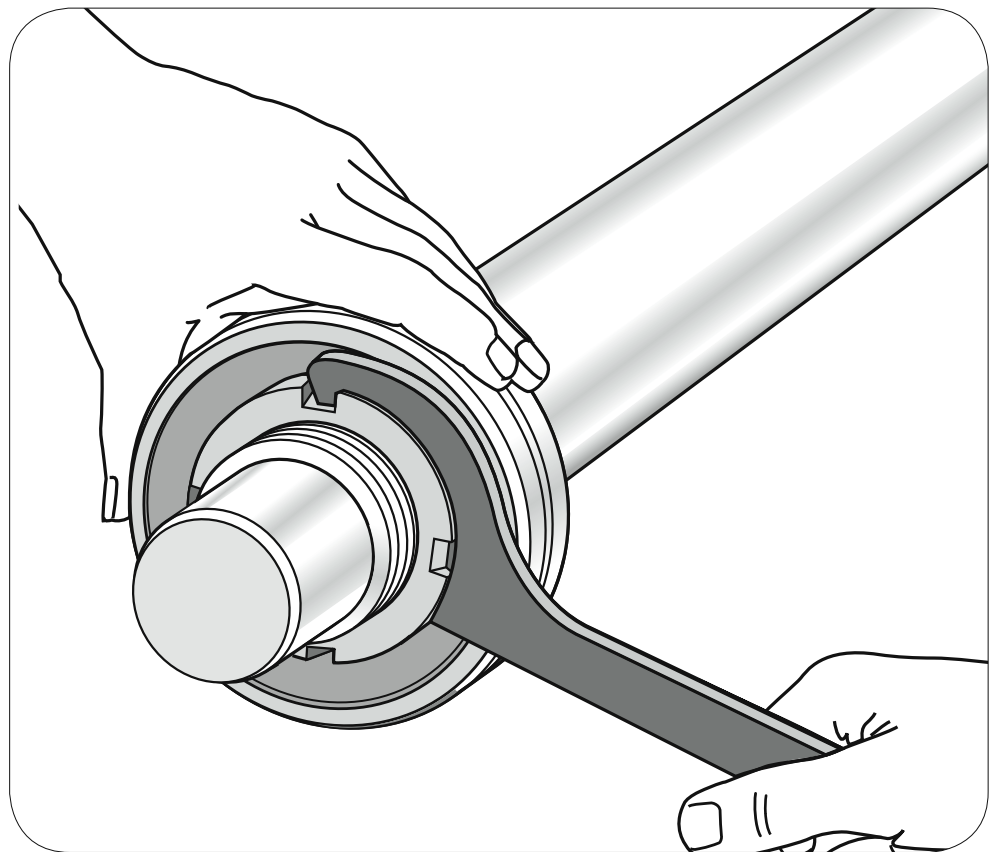

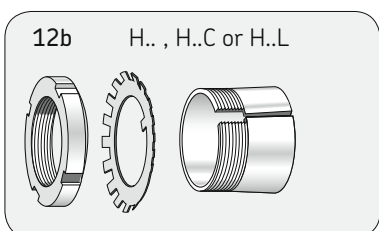
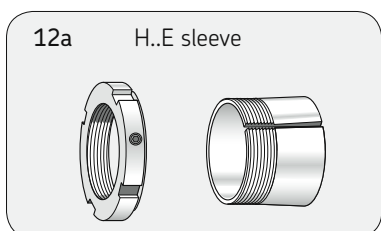
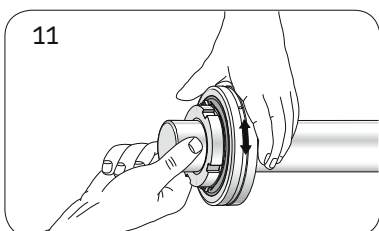
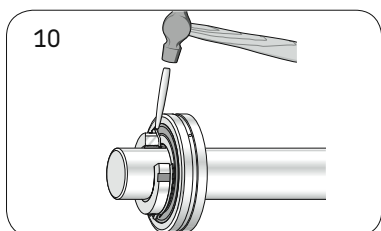
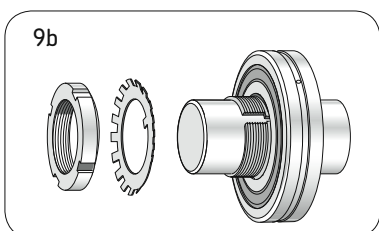
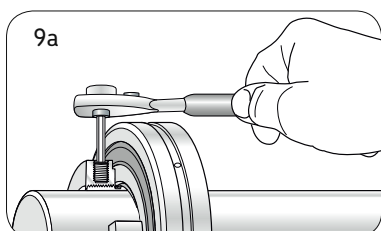
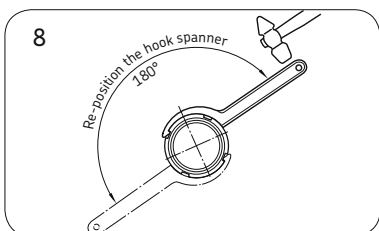
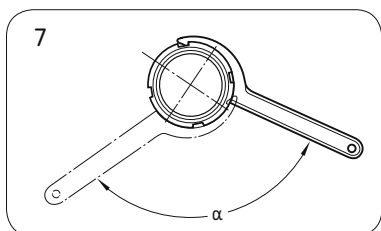
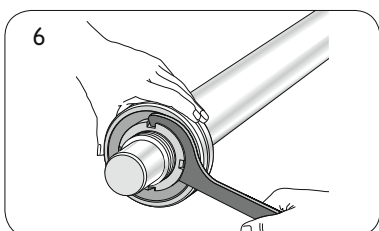
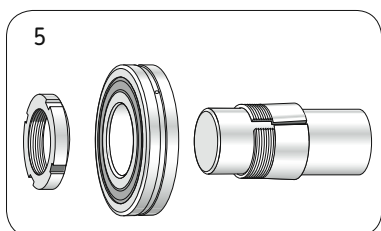
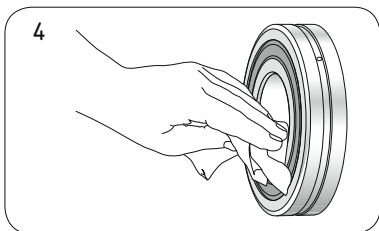
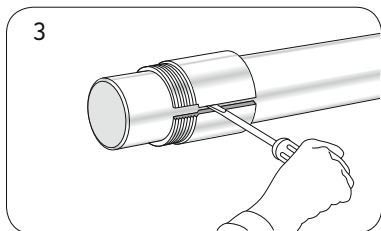
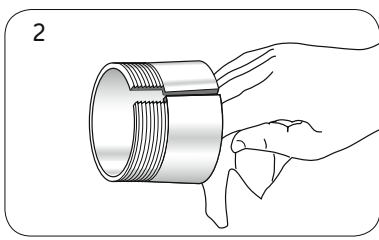
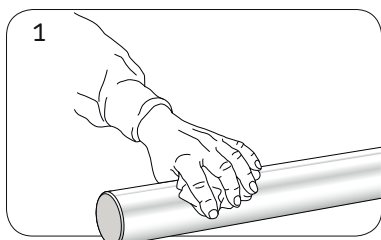

1. Thoroughly clean the shaft and apply a thin coat of light mineral oil to the contact area.
2. Wipe the preservative from all surfaces of the sleeve. Then apply a thin coat of light mineral oil to the bore of the sleeve.
3. Slide the sleeve along the shaft to the correct position. If necessary, insert a screwdriver in the slit to open the sleeve, being careful not to damage the shaft.
4. Wipe the preservative from the bore of the bearing. Then, apply a thin coat of light mineral oil.
5. Place the bearing on the sleeve. Then turn the nut up lightly against the bearing (if you have a locking washer, do not install it at this stage). Be sure the chamfer on the nut is toward the bearing. Also be sure that when turning the nut, the bearing is not pushed further up the sleeve.
6. Find the starting position for the angle tightening, by turning the nut until the sleeve is firmly in place on the shaft. Using a felt pen, mark the appropriate tightening angle on the shaft and the nut – see adjacent table.
7. Tighten the nut to the required tightening angle, using the appropriate SKF hook or impact spanner – see adjacent table.
8. Re-position the spanner 180° and tap the spanner handle lightly with a hammer. This will straighten up the bearing if it is skewed on the shaft.

When using a H..E sleeve (Fig. 12a)

9a. Tighten the grub screw with a torque wrench, see table. Then, go to step 11.

When using a H.., H..C or H..L sleeve (Fig. 12b)

9b. Unscrew the nut, install the locking washer and re-tighten the nut. Make sure not to drive the bearing any further up the sleeve.

10. Lock the nut in place by bending one of the locking washer tabs down into one of the slots in the nut. Do not bend the tab to the bottom of the slot.

11. Check that the shaft or outer ring can be rotated by hand.

Note:

For large bearings this can be quite difficult due to the weight of the bearing or shaft, and drag losses resulting from the grease and seals.

Bearing	Lock nut	KMFE Allen key	Tightening angle	KMFE Allen key locking torque	Hook spanner, impact spanner
–	–	mm	Angular deg.	Nm	–
BS2-2207-2CSK/VT143	KMFE 7	2,5	115	4,5	HN 7/SNL
BS2-2208-2CSK/VT143	KMFE 8	3	125	8	HN 8/SNL
BS2-2308-2CSK/VT143	KMFE 8	3	125	8	HN 8/SNL
BS2-2209-2CSK/VT143	KMFE 9	3	130	8	HN 9/SNL
BS2-2309-2CSK/VT143	KMFE 9	3	135	8	HN 9/SNL
BS2-2210-2CSK/VT143	KMFE 10	3	140	8	HN 10/SNL
BS2-2310-2CSK/VT143	KMFE 10	3	140	8	HN 10/SNL
BS2-2211-2CSK/VT143	KMFE 11	3	110	8	HN 11/SNL
BS2-2311-2CSK/VT143	KMFE 11	3	110	8	HN 11/SNL
BS2-2212-2CSK/VT143	KMFE 12	3	115	8	HN 12/SNL
BS2-2312-2CSK/VT143	KMFE 12	3	120	8	HN 12/SNL
BS2-2213-2CSK/VT143	KMFE 13	3	120	8	HN 13/SNL
BS2-2313-2CSK/VT143	KMFE 13	3	125	8	HN 13/SNL
BS2-2214-2CSK/VT143	KMFE 14	3	125	8	HN 14/SNL
BS2-2314-2CSK/VT143	KMFE 14	3	130	8	HN 14/SNL
BS2-2215-2CSK/VT143	KMFE 15	3	130	8	HN 15/SNL
BS2-2315-2CSK/VT143	KMFE 15	3	135	8	HN 15/SNL
BS2-2216-2CSK/VT143	KMFE 16	4	135	18	HN 16/SNL
BS2-2316-2CSK/VT143	KMFE 16	4	140	18	HN 16/SNL
BS2-2217-2CSK/VT143	KMFE 17	4	145	18	HN 17/SNL
BS2-2218-2CSK/VT143	KMFE 18	4	150	18	HN 18/SNL
23218-2CSK/VT143	KMFE 18L	4	150	18	HN 18/SNL
BS2-2219-2CSK/VT143	KMFE 19L	4	155	18	HN 19/SNL
23120-2CSK/VT143	KMFE 20	4	160	18	HN 20/SNL
BS2-2220-2CSK/VT143	KMFE 20	4	160	18	HN 20/SNL
23220-2CSK/VT143	KMFE 20	4	160	18	HN 20/SNL
23022-2CSK/VT143	KMFE 22	4	170	18	HN 22/SNL
23122-2CSK/VT143	KMFE 22	4	170	18	HN 22/SNL
BS2-2222-2CSK/VT143	KMFE 22	4	170	18	HN 22/SNL
23222-2CSK/VT143	KMFE 22	4	175	18	HN 22/SNL
23024-2CSK/VT143	KMFE 24	5	180	35	TMFN 23-30
BS2-2224-2CSK/VT143	KMFE 24	5	185	35	TMFN 23-30
23224-2CSK/VT143	KML 24	–	185	–	TMFN 23-30
22324-2CSK/VT143	KM 24	–	195	–	TMFN 23-30
23026-2CSK/VT143	KMFE 26	5	190	35	TMFN 23-30
BS2-2226-2CSK/VT143	KML 26	–	195	–	TMFN 23-30
22326-2CSK/VT143	KM 26	–	195	–	TMFN 23-30
23226-2CSK/VT143	KML 26	–	205	–	TMFN 23-30
23028-2CSK/VT143	KMFE 28	5	200	35	TMFN 23-30
22228-2CSK/VT143	KML 28	–	205	–	TMFN 23-30
23228-2CSK/VT143	KM 28	–	205	–	TMFN 23-30
22328-2CSK/VT143	KM 28	–	215	–	TMFN 23-30
23030-2CSK/VT143	KMFE 30	5	210	35	TMFN 30-40
23130-2CSK/VT143	KMFE 30	5	215	35	TMFN 30-40
22230-2CSK/VT143	KM 30	–	220	–	TMFN 30-40
23230-2CSK/VT143	KML 30	–	220	–	TMFN 30-40
22330-2CSK/VT143	KM 30	–	230	–	TMFN 30-40
23032-2CSK/VT143	KMFE 32	5	150	35	TMFN 30-40
23132-2CSK/VT143	KMFE 32	5	150	35	TMFN 30-40
22232-2CSK/VT143	KM 32	–	155	–	TMFN 30-40
22332-2CSK/VT143	KM 32	–	160	–	TMFN 30-40
23034-2CSK/VT143	KMFE 34	5	155	35	TMFN 30-40
23134-2CSK/VT143	KMFE 34	5	160	35	TMFN 30-40
22234-2CSK/VT143	KM 34	–	160	–	TMFN 30-40
23036-2CSK/VT143	KML 36	–	165	–	TMFN 30-40
23136-2CSK/VT143	KML 36	–	165	–	TMFN 30-40
22236-2CSK/VT143	KM 36	–	170	–	TMFN 30-40



® SKF is a registered trademark of SKF USA Inc.

The contents of this publication are the copyright of the publisher and may not be reproduced (even extracts) unless prior written permission is granted. Every care has been taken to ensure the accuracy of the information contained in this publication but no liability can be accepted for any loss or damage whether direct, indirect or consequential arising out of use of the information contained herein.