

Super-precision angular contact ball bearings: High-capacity

72 .. D (E 200) series

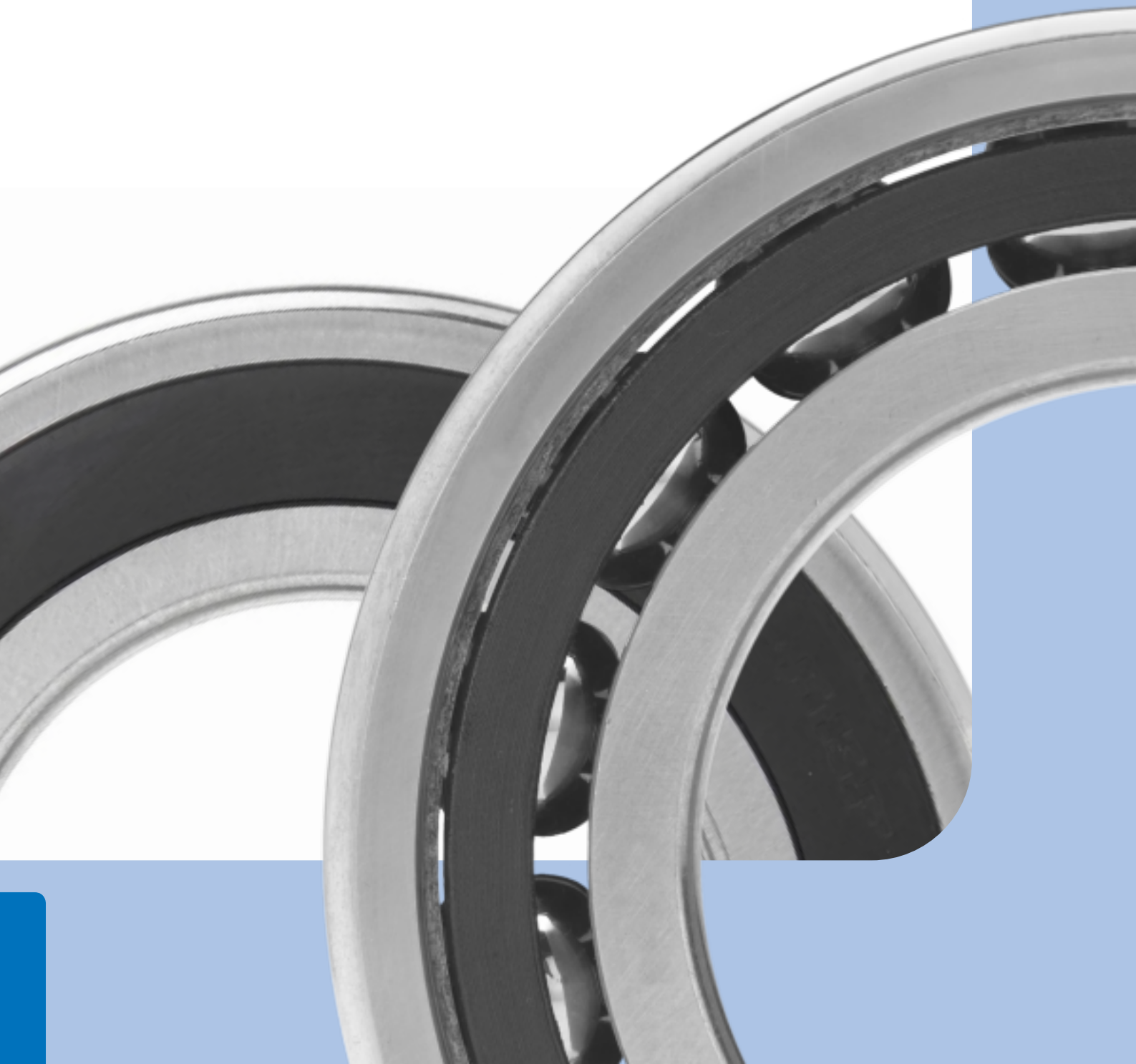



The SKF brand now stands for more than ever before, and means more to you as a valued customer.

While SKF maintains its leadership as a high-quality bearing manufacturer throughout the world, new dimensions in technical advances, product support and services have evolved SKF into a truly solutions-oriented supplier, creating greater value for customers.

These solutions enable customers to improve productivity, not only with breakthrough application-specific products, but also through leading-edge design simulation tools and consultancy services, plant asset efficiency maintenance programmes, and the industry's most advanced supply management techniques.

The SKF brand still stands for the very best in rolling bearings, but it now stands for much more.

SKF – the knowledge engineering company

Contents

A Product information

SKF high-capacity super-precision angular contact ball bearings 3

An extended range – a growing assortment 4

Bearing design 5

Bearing series 6

Bearing variants 6

Single bearings and matched bearing sets 7

Applications 8

B Recommendations

Bearing arrangement design 10

Single bearings 10

Bearing sets 10

Type of arrangement 11

Application examples 12

Lubrication 14

Grease lubrication for open bearings . . 14

Sealed bearings 15

Running-in of open and sealed, grease lubricated bearings 15

Oil lubrication for open bearings 16

C Product data

Bearing data – general 18

Boundary dimensions 18

Chamfer dimensions 18

Tolerances 18

Bearing preload 18

Bearing axial stiffness 22

Fitting and clamping of bearing rings . . 24

Load carrying capacity of bearing sets . 25

Equivalent bearing loads 26

Attainable speeds 26

Cages 26

Seals 27

Materials 27

Heat treatment 27

Marking of bearings and bearing sets . . 28

Packaging 29

Designation system 29

Product tables 32

D Additional information

Setting the highest standard for precision bearings 42

Super-precision angular contact ball bearings 42

Super-precision cylindrical roller bearings 43

Super-precision double direction angular contact thrust ball bearings 43

Super-precision angular contact thrust ball bearings for screw drives 43

Super-precision axial-radial cylindrical roller bearings 43

SKF – the knowledge engineering company 46

SKF high-capacity super-precision angular contact ball bearings

Machine tools and other precision applications require superior bearing performance. In these applications, high system rigidity is one of the main performance challenges, as the magnitude of elastic deformation under load determines the productivity and accuracy of the equipment. Parallel Kinematic Machines (PKM), for example, are known for their ability to provide high structural rigidity and high dynamic capacities. But this is only possible when the bearings inside these machines step up to the challenge. SKF has developed a new generation of super-precision angular contact ball bearings that can meet these ever-increasing performance requirements. The ability of the new design super-precision angular contact ball bearings in the 72 .. D (*E 200*)¹⁾ series to accommodate heavy loads, and still provide a high degree of rigidity, makes them an excellent solution for these and similar applications.

SKF bearings in the 72 .. D (*E 200*) series are characterized by:

- high load carrying capacity
- high degree of stiffness
- extended bearing service life
- low heat generation
- low noise and vibration levels

The bearings provide high reliability and superior accuracy for applications such as Parallel Kinematic Machines (PKM), lathe spindles, grinding and boring machines, high-speed dynamometers and turbochargers.



¹⁾ Where applicable, designations in parentheses and italics refer to the corresponding SNFA equivalent.

An extended range – a growing assortment

The growing SKF assortment of super-precision bearings is now complemented by angular contact ball bearings in the 72 .. D (E 200) series. The extended range of bearings in this series now accommodates shaft diameters ranging from 7 to 140 mm. And, there is also a relubrication-free, sealed bearing series, available on request.

To accommodate the diverse operating requirements of precision applications, bearings in the 72 .. D (E 200) series are manufactured to two tolerance classes and with two contact angles. Those suitable for universal matching or mounting in sets are produced to four preload classes, to meet almost all application requirements in terms of speed and rigidity. Matched bearing sets with a special preload can be supplied on request. For many sizes, the bearings are available, standard, with a choice of two ball materials. The most common sizes have a polyetheretherketone (PEEK) cage to accommodate extended operating temperatures.

Bearings in the 72 .. D (E 200) series, like all angular contact ball bearings, are nearly always adjusted against a second bearing to balance the counterforces. To accommodate heavier loads and axial loads in both directions, the bearings are used in sets consisting typically of up to four bearings.

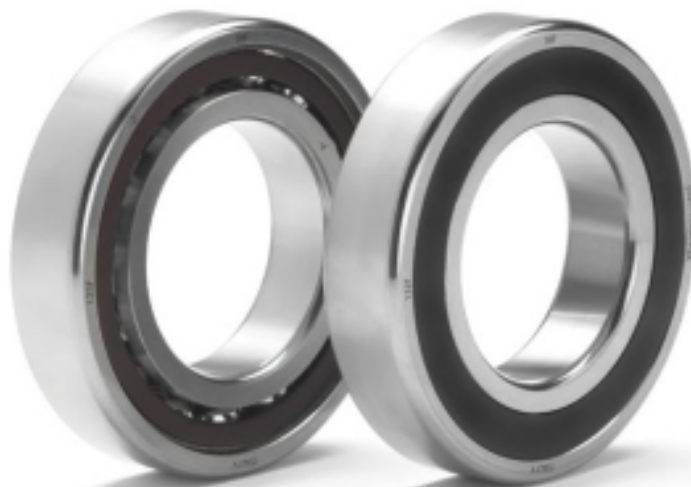

SKF super-precision angular contact ball bearings: 72 .. D (E 200) series

Features

- High number of large balls
- Optimized chamfer design
- ISO dimension series O2
- Asymmetrical outer ring
- Lightweight cage (phenolic resin or PEEK)
- High-temperature PEEK cage, for most common sizes
- High-speed grease, for sealed variant
- Non-contact seals, for sealed variant

Benefits

- High load carrying capacity, high degree of rigidity
- Facilitated mounting
- Large cross section, robust
- Accommodates radial loads, and axial loads in one direction
- Low friction, good lubricant supply to ball/raceway contact areas
- Accommodates operating temperatures up to 150 °C
- High-speed capability, relubrication-free, good thermal stability
- High-speed capability, prevents entry of contaminants, extended bearing service life

Bearing design

SKF super-precision single row angular contact ball bearings in the 72 .. D (E 200) series are designed to accommodate heavy loads at relatively high speeds under low to moderate operating temperatures.

Features of D design bearings include, among others:

- a symmetrical inner ring
- an asymmetrical outer ring
- a high number of large balls
- a lightweight cage, outer ring shoulder-guided
- an optimized chamfer design

The design of the symmetrical inner ring and asymmetrical outer ring enables the bearings to accommodate radial loads, and axial loads in one direction. When compared to other precision angular contact ball bearings, D design bearings have a high number of large balls to provide the highest possible load carrying capacity. The bearings have an outer ring shoulder-guided cage made of either fabric reinforced phenolic resin or carbon fibre reinforced polyetheretherketone (PEEK). Both cage types are designed to enable good lubricant supply to the ball/raceway contact areas. The shape of the chamfers of the inner and outer rings is optimized for improved mounting accuracy. As a result, mounting is not only facilitated, but there is also less risk of damage to associated components.

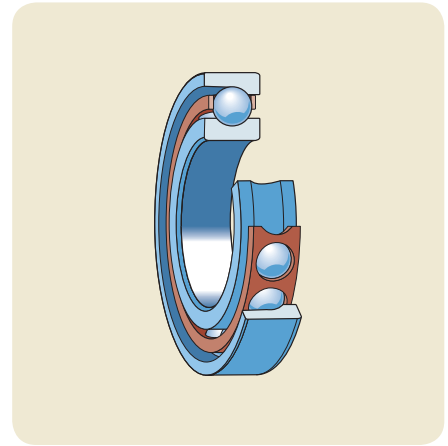

D design bearings have a high number of large balls to accommodate heavy loads.

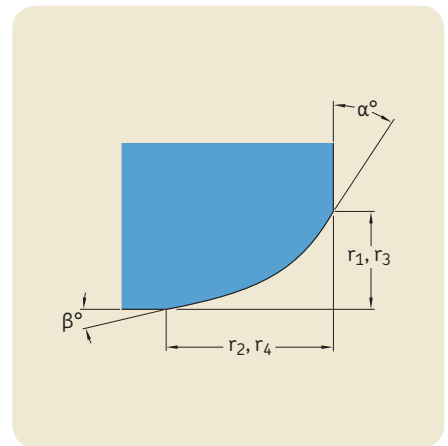

Optimized design of bearing ring chamfers to facilitate mounting.



Bearing series

Bearings in the 72 .. D (E 200) series are based on the ISO diameter series 2 and width series 0. Bearings in the 72 series are more robust and have the largest cross section for a given bore diameter, compared to bearings in the 718, 719 and 70 series.

Bearing variants

The many variants of SKF bearings in the 72 .. D (E 200) series are well suited to accommodate various operating conditions with regard to load, speed and rigidity.

Contact angles

Standard bearings are manufactured with the following contact angles:

- a 15° contact angle, designation suffix CD (1)
- a 25° contact angle, designation suffix ACD (3)

With two contact angles to choose from, designers can optimize their application based on axial load, speed and rigidity requirements. A larger contact angle provides a higher degree of axial stiffness and a higher axial load carrying capacity. Speed capability is subsequently reduced.



Bearings in the 72 series are more robust and have the largest cross section for a given bore diameter, compared to bearings in other series.

Two contact angles to accommodate different axial load, speed and rigidity requirements.

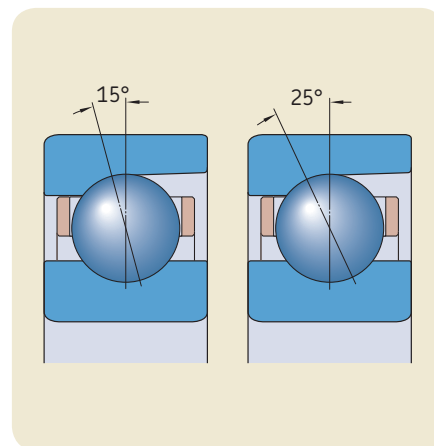
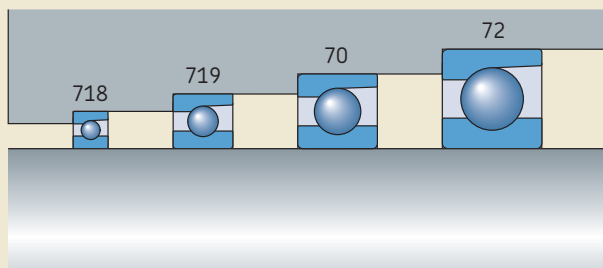

Ball materials

Bearings with a bore diameter up to 85 mm are available, standard, with:

- steel balls, no designation suffix
- ceramic (bearing grade silicon nitride) balls, designation suffix HC (/NS)

Larger bearings are available, standard, with steel balls and can be supplied with ceramic balls on request.

As ceramic balls are considerably lighter and harder than steel balls, hybrid bearings can provide a higher degree of rigidity and run considerably faster than comparably sized all-steel bearings. The lower weight of the ceramic balls reduces the centrifugal forces within the bearing and generates less heat. Lower centrifugal forces are particularly important in machine tool applications where there are frequent rapid starts and stops. Less heat generated by the bearing means less energy consumption and longer bearing and grease service life.

Sealed bearings

Bearings with a bore diameter ranging from 10 to 80 mm can be supplied with an integral seal fitted on both sides and filled with premium grease. The seal forms an extremely narrow gap with the cylindrical surface of the inner ring shoulder.

When compared to bearing arrangements with open bearings and external seals, those with sealed bearings provide a number of advantages including:

- extended bearing service life
- reduced need for maintenance
- reduced inventory
- reduced risk of lubricant contamination during mounting and operation

Sealed bearings are identified by the designation prefix *S* (suffix /*S*).

Single bearings and matched bearing sets

Bearings in the 72 .. D (*E 200*) series are available, standard, as:

- single bearings
- single, universally matchable bearings
- matched bearing sets
- sets of universally matchable bearings

A hybrid variant is available, standard, for bearings with a bore diameter up to 85 mm.

Certain sizes are available in a sealed variant.

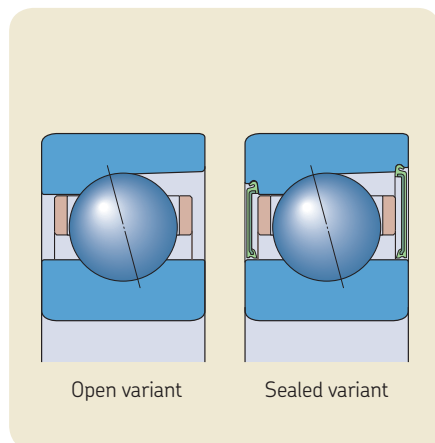
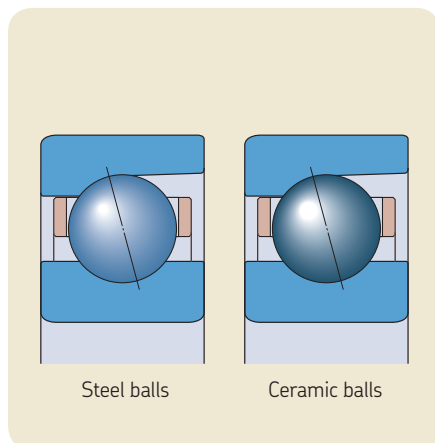

Applications

The SKF assortment of super-precision angular contact ball bearings in the 72 .. D (E 200) series offers solutions to many bearing arrangement challenges. Their ability, among others, to provide a high degree of rigidity and accommodate heavy loads at relatively high speeds is beneficial for a variety of applications.

Lathe spindles, for example, require high load carrying capacity and high positioning accuracy. Depth of cut and feed rates are usually pushed to the limit, and depend on the required surface finish.

Other applications include dynamometers for engine testing and Parallel Kinematic Machines (PKM). A dynamometer requires a high degree of rigidity and high-speed capability. To limit the errors in the readings, low vibration and noise levels as well as low friction are critical. A PKM requires high load carrying capacity and a high degree of rigidity to limit bending, which lowers machine accuracy.

For these and other precision applications, there is an optimal arrangement incorporating bearings in the 72 .. D (E 200)

series, to provide the best possible combination of rigidity, load carrying capacity, heat generation and bearing service life.

Applications

- Machine tool spindles
- Lathes (main spindle, tailstock)
- Grinding machines
- Boring machines
- Parallel Kinematic Machines (PKM)
- Dynamometers for engine testing
- High-speed turbochargers

Requirements

- High load carrying capacity
- High degree of rigidity
- High-speed capability
- High positioning accuracy
- Long service life
- Low vibration and noise levels
- Low friction
- Facilitated mounting
- Increased machine uptime

Solution



SKF super-precision angular contact ball bearings in the 72 .. D (E 200) series

A

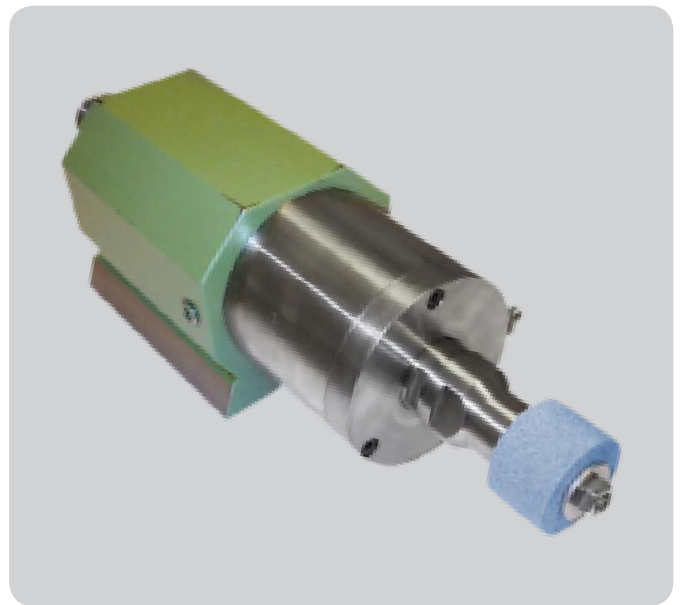

Bearing arrangement design

Bearing arrangements using SKF super-precision angular contact ball bearings in the 72 .. D (E 200) series can be designed using single bearings or bearing sets. An example of the ordering possibilities for a three-bearing arrangement is provided in **table 1**.

Single bearings

Bearings in the 72 .. D (E 200) series are available as single (stand-alone) bearings or single, universally matchable bearings. When ordering single bearings, indicate the number of individual bearings required.

Single bearings

Single bearings are intended for arrangements where only one bearing is used in each bearing position. Although the width of the bearing rings is made to very tight tolerances, these bearings are not suitable for mounting immediately adjacent to each other.

Single, universally matchable bearings

Universally matchable bearings are specifically manufactured so that when mounted in random order, but immediately adjacent to each other, a given preload and/or even load distribution is obtained without the use of shims or similar devices. These bearings can be mounted in random order for any desired bearing arrangement.

Single, universally matchable bearings are identified by the designation suffix G (U).

Bearing sets

Bearings in the 72 .. D (E 200) series are available as matched bearing sets or as sets of universally matchable bearings. When ordering bearing sets, indicate the number of bearing sets required (the number of individual bearings per set is specified in the designation).

Matched bearing sets

Bearings can be supplied as complete bearing sets consisting of two, three or four bearings. The bearings are matched to each other during production so that when mounted immediately adjacent to each other, in a specified order, a given preload and/or even load distribution is obtained

without the use of shims or similar devices. The bore and outside diameters of these bearings are matched to within a maximum of one-third of the applicable permitted diameter tolerance, resulting in an even better load distribution when mounted, compared to single, universally matchable bearings.

Sets of universally matchable bearings

The bearings in these sets can be mounted in random order for any desired bearing arrangement. The bore and outside diameters of universally matchable bearings in a set are matched to within a maximum of one-third of the applicable permitted diameter tolerance, resulting in an even better load distribution when mounted, compared to single, universally matchable bearings.

Like single, universally matchable bearings, sets of universally matchable bearings are identified by the designation suffix G (U), but their positions in the designation differ (→ **table 1**).

Table 1

Example of the ordering possibilities for a three-bearing arrangement

Design criteria	What to order	Bearing designation ¹⁾	Order example
Bearing arrangement is not known	Three single, universally matchable bearings	72 .. DG../P4A (E 2.. 7CE .. U..)	3 x 7214 CDGA/P4A (3 x E 270 7CE1 UL)
Bearing arrangement is not known and improved load distribution is desirable	A set of three universally matchable bearings	72 .. D/P4ATG.. (E 2.. 7CE .. TU..)	1 x 7214 CD/P4ATGA (1 x E 270 7CE1 TUL)
Bearing arrangement is known	Three bearings in a matched set	72 .. D/P4AT.. (E 2.. 7CE .. T..)	1 x 7214 CD/P4ATBTA (1 x E 270 7CE1 TDL)

¹⁾ For additional information about designations, refer to **table 16** on **pages 30** and **31**.

Type of arrangement

Universally matchable bearings and matched bearing sets can be arranged in various configurations depending on the stiffness, rigidity and load requirements of the application. The possible configurations are shown in **fig. 1**, including the designation suffixes applicable to matched bearing sets.

Back-to-back bearing arrangement

In a back-to-back bearing arrangement, the load lines diverge toward the bearing axis. Axial loads acting in both directions can be accommodated, but only by one bearing or bearing set in one direction each. Bearings mounted back-to-back provide a relatively rigid bearing arrangement that can also accommodate tilting moments.

Face-to-face bearing arrangement

In a face-to-face bearing arrangement, the load lines converge toward the bearing axis. Axial loads acting in both directions can be accommodated, but only by one bearing or bearing set in one direction each. Face-to-face arrangements can accommodate small amounts of deflection.

Tandem bearing arrangement

The axial load carrying capacity of a bearing arrangement can be increased by adding bearings mounted in tandem. In a tandem bearing arrangement, the load lines are parallel so that radial and axial loads are shared equally by the bearings in the set. The bearing set can only accommodate axial loads acting in one direction. If axial loads act in the opposite direction, or if combined loads are present, additional bearing(s) adjusted against the tandem bearing arrangement should be added.

Fig. 1

Bearing sets with 2 bearings

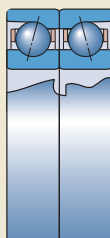

Back-to-back arrangement
Designation suffix DB (DD)

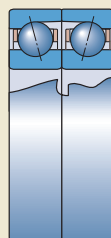

Face-to-face arrangement
Designation suffix DF (FF)

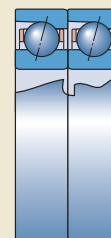

Tandem arrangement
Designation suffix DT (T)

Bearing sets with 3 bearings

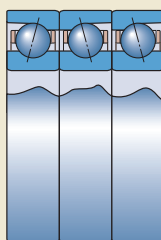

Back-to-back and tandem
arrangement
Designation suffix TBT (TD)

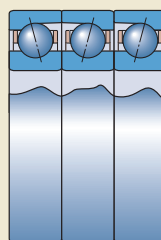

Face-to-face and tandem
arrangement
Designation suffix TFT (TF)

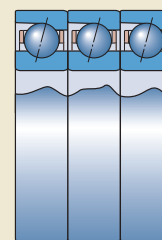

Tandem arrangement
Designation suffix TT (3T)

Bearing sets with 4 bearings

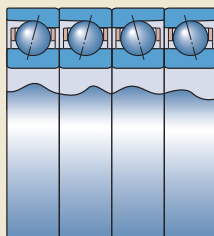

Tandem back-to-back
arrangement
Designation suffix QBC (TDT)

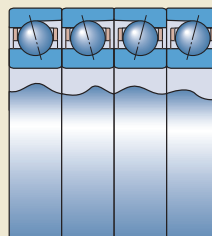

Tandem face-to-face
arrangement
Designation suffix QFC (TFT)

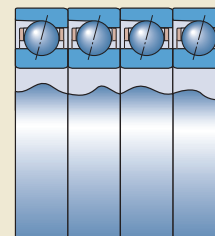

Tandem arrangement
Designation suffix QT (4T)



Back-to-back and tandem
arrangement
Designation suffix QBT (3TD)

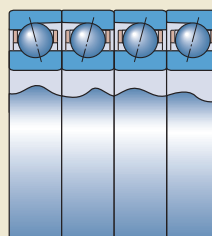

Face-to-face and tandem
arrangement
Designation suffix QFT (3TF)

Application examples

Super-precision angular contact ball bearings are common in, but not limited to, machine tool spindles. Depending on the type of machine tool and its intended purpose, spindles may require different bearing arrangements.

Lathe spindles are often driven directly by a motor. The spindle is then referred to as a motorized spindle or electro-spindle. As a result, there are typically light radial loads at the non-tool end of the shaft. On the tool end of the shaft, where there are heavy

loads, a high degree of rigidity and high load carrying capacity are important operational requirements. It is, therefore, common to have a set of three or four angular contact ball bearings in the 72 .. D (E200) series at the tool end and a cylindrical roller bearing at the non-tool end of the shaft. For grinding applications, where the speeds are relatively high, typical bearing arrangements incorporate sets of angular contact ball bearings in the 72 .. D (E200) series at both ends of the spindle.

In Parallel Kinematic Machines (PKM) and dynamometers used for engine testing, a high degree of rigidity is paramount. Therefore, sets of angular contact ball bearings in the 72 .. D (E 200) series, mounted in a back-to-back arrangement, are frequently used. For high-speed dynamometers, bearings with ceramic balls are popular.

Lathe tailstock

A lathe tailstock requires a high degree of rigidity under relatively heavy loads. This tailstock uses a matched set of four super-precision angular contact ball bearings mounted in a back-to-back and tandem arrangement at the back, e.g. 7210 ACD/P4AQBTB (E 250 7CE3 3TD85daN). The front of the tailstock uses a high-precision double row cylindrical roller bearing, e.g. NN 3015 KTN/SP.

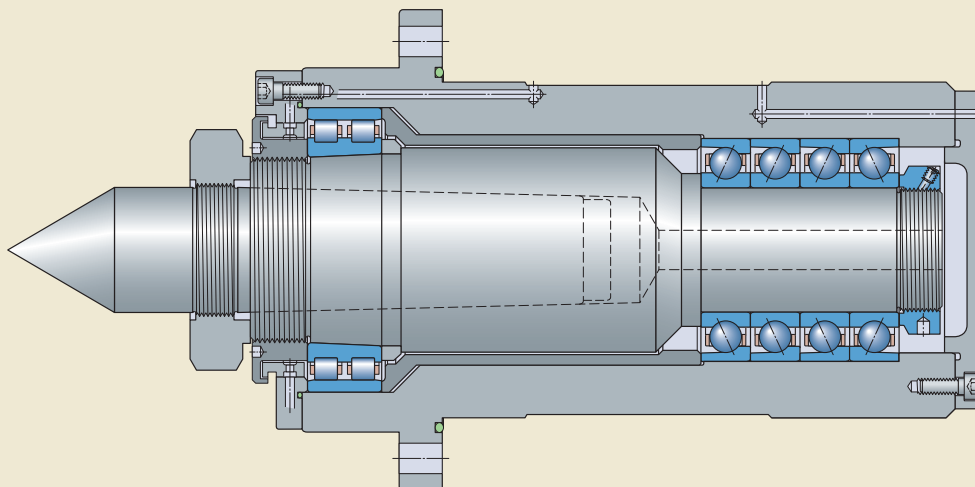

Grinding spindle

Grinding spindles typically operate at high speeds, under relatively heavy loads. This spindle uses two tandem pairs of super-precision angular contact ball bearings mounted back-to-back, e.g. 2 x 7205 CD/P4ADT (E 225 7CE1 T). The bearings in each pair are separated by a set of precision-matched spacer rings. Springs at the non-tool end provide a consistent preload during operation.

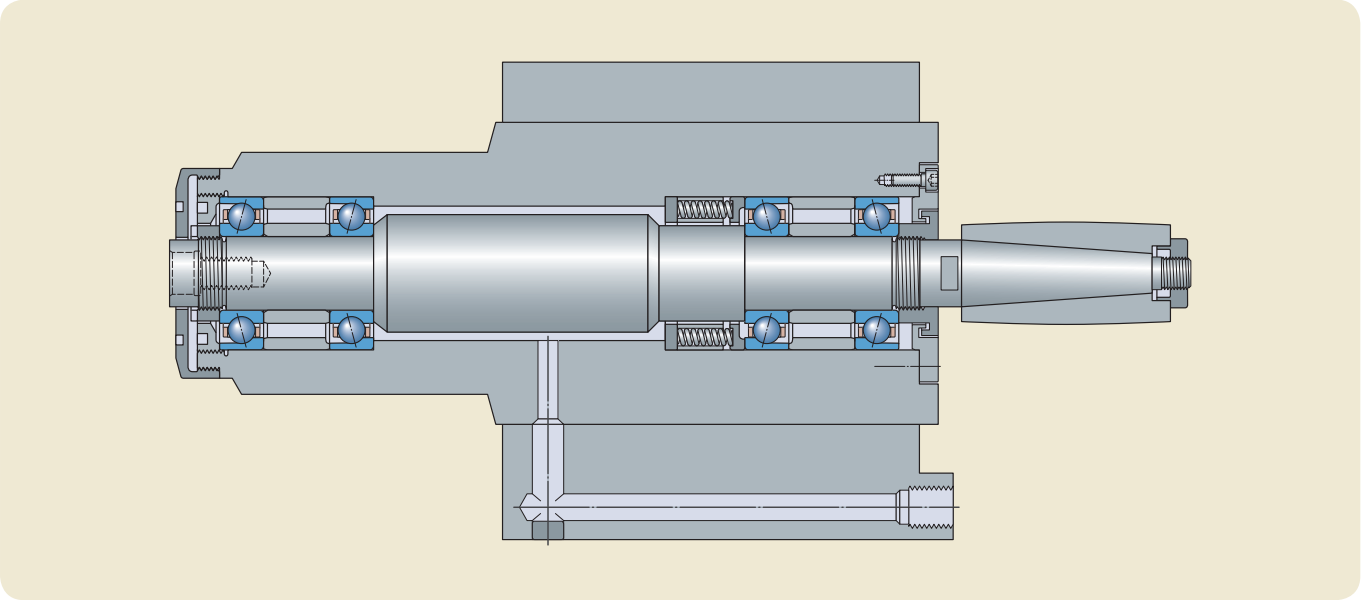

Lathe electro-spindle

This lathe spindle is designed for large diameter bar stock. The tool end has a matched set of super-precision angular contact ball bearings mounted in a back-to-back and tandem arrangement separated by a set of precision-matched spacer rings for maximum rigidity, e.g. 7216 ACD/P4ATBTA (E 280 7CE3 TDL). A high-precision single row cylindrical roller bearing is on the non-tool end, e.g. N 1010 KTN/SP.

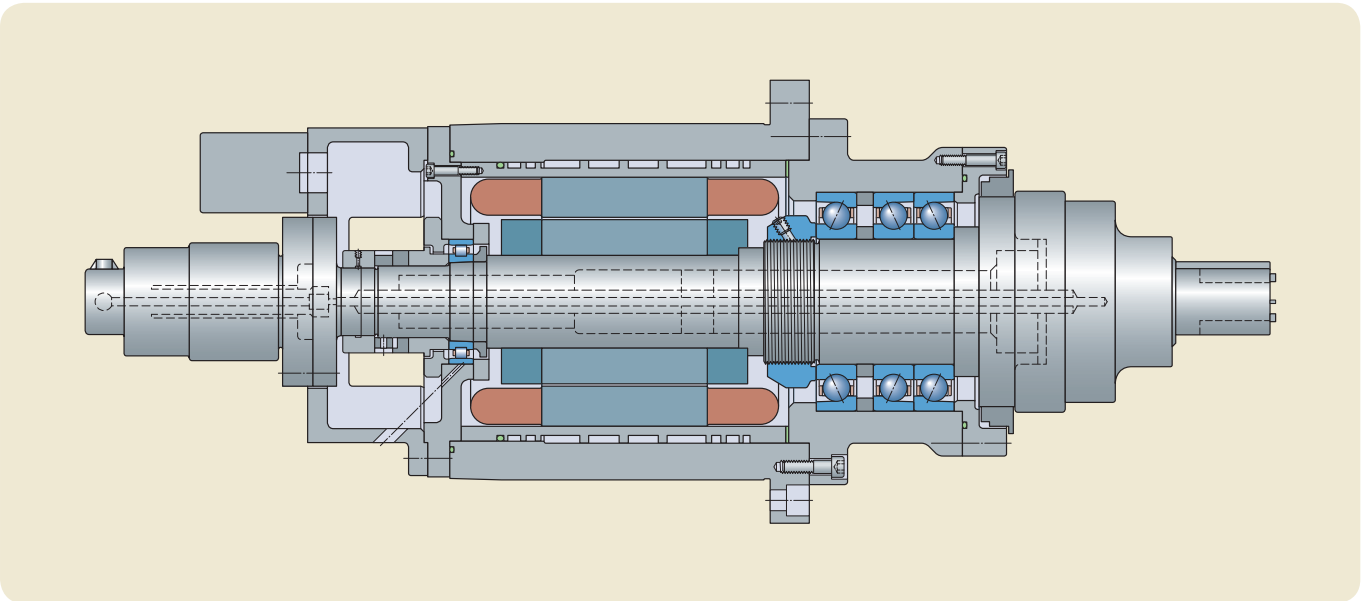

Lubrication

Heat resulting from friction is a constant threat to production equipment. One way to reduce heat and the wear associated with friction, particularly in bearings, is to be sure that the correct quantity of the appropriate lubricant reaches all necessary parts.

For an adequate lubricant film to be formed between the balls and raceways of super-precision angular contact ball bearings, only a very small amount of lubricant is required. With grease lubrication, the hydrodynamic friction losses are small and operating temperatures can be kept to a minimum. However, where speeds are constantly very high (generally, speed factor $A > 1\,400\,000$ mm/min), the bearings should be lubricated with oil, as the service life of grease is too short under these conditions and oil provides the added benefit of cooling.

Grease lubrication for open bearings

In most applications with open bearings in the 72 .. D (E 200) series, grease with a mineral base oil and lithium thickener is suitable. These greases, which adhere well to the bearing surfaces, can accommodate operating temperatures ranging from -30 to $+100$ °C.

Initial grease fill

In high-speed applications, less than 30% of the free space in the bearings should be filled with grease. The initial grease fill depends on the bearing size as well as the speed factor, which is

$$A = n d_m$$

where

A = speed factor [mm/min]

n = rotational speed [r/min]

d_m = bearing mean diameter
= $0,5 (d + D)$ [mm]

The initial grease fill for open bearings can be estimated by

$$G = K G_{ref}$$

where

G = initial grease fill [cm³]

K = a calculation factor dependent on the speed factor A (→ diagram 1)

G_{ref} = reference grease quantity (→ table 1) [cm³]

Table 1

Reference grease quantity for initial grease fill estimation

Bearing Bore diameter d	Size	Reference grease quantity ¹⁾ for open bearings G_{ref}
mm	–	cm ³
7	7	0,16
8	8	0,23
9	9	0,26
10	00	0,36
12	01	0,51
15	02	0,73
17	03	1
20	04	1,5
25	05	1,9
30	06	2,8
35	07	3,9
40	08	4,7
45	09	5,9
50	10	6,7
55	11	8,6
60	12	10,1
65	13	12,5
70	14	13,7
75	15	14,9
80	16	18,1
85	17	21,8
90	18	27,8
95	19	34,3
100	20	40,9
105	21	48,3
110	22	54,2
120	24	69,1
130	26	72,4
140	28	83,9

¹⁾ Refers to a 30% filling grade.

Diagram 1

Factor K for initial grease fill estimation

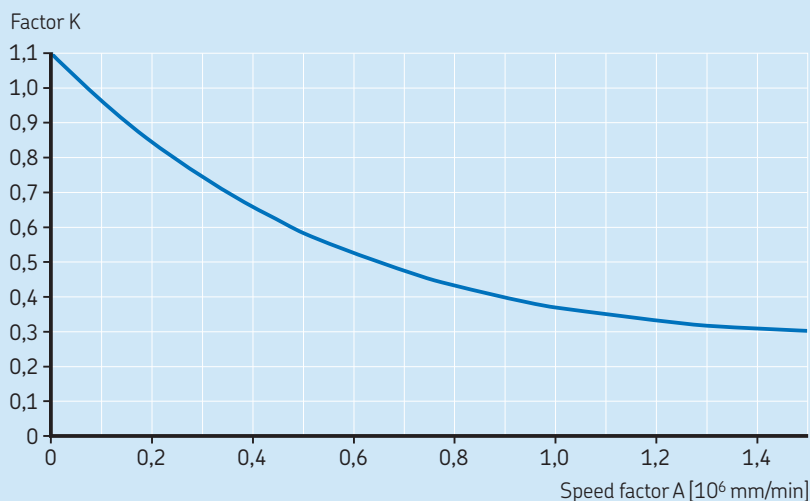

Sealed bearings

Sealed bearings in the S72 .. D (E 200 /S) series are filled with a high-grade, low viscosity grease that fills approximately 15% of the free space in the bearing. The bearings are relubrication-free under normal operating conditions. The grease is characterized by:

- high-speed capability (speed factor A up to 1 200 000 mm/min)
- excellent ageing resistance
- very good rust inhibiting properties

The technical specifications of the grease are provided in **table 2**.

Running-in of open and sealed, grease lubricated bearings

A grease lubricated super-precision bearing will initially run with a relatively high frictional moment. If the bearing is run at high speed without a running-in period, the temperature rise can be considerable. The relatively high frictional moment is due to the churning of the grease and it takes time for the excess grease to work its way out of the contact zone. For open bearings, this time period can be minimized by applying a small quantity of grease distributed evenly on both sides of the bearing during the assembly stage. Spacers between two adjacent bearings are also beneficial (→ *Adjusting preload with spacer rings*, **page 22**).

The time required to stabilize the operating temperature depends on a number of factors – the type of grease, the initial grease fill, how the grease is applied to the bearings, and the running-in procedure (→ **diagram 2, page 16**).

Super-precision bearings can typically operate with a minimum quantity of lubricant when properly run-in, enabling the lowest frictional moment and temperature to be achieved. Grease that collects on each side of the bearing acts as a reservoir, enabling oil to bleed into the raceway to provide effective lubrication for a long time.

B

Table 2

Technical specifications of the grease in sealed bearings

Properties	Grease specification
Thickener	Special lithium soap
Base oil type	Ester/PAO
NLGI consistency class	2
Temperature range [°C] [°F]	-40 to +120 -40 to +250
Kinematic viscosity [mm ² /s] at 40 °C at 100 °C	25 6

Running-in can be done in several ways. Wherever possible and regardless of the procedure chosen, running-in should involve operating the bearing in both a clockwise and anticlockwise direction. For additional information about running-in procedures, refer to the *SKF Interactive Engineering Catalogue* available online at www.skf.com.

Oil lubrication for open bearings

Oil lubrication is recommended for open bearings in the 72 .. D (E 200) series in applications where very high speeds (generally, speed factor $A > 1\,400\,000$ mm/min) preclude the use of grease as a lubricant.

Guidelines for the quantity of oil to be supplied to each bearing for very high speed operation can be obtained from

$$Q = 1,3 d_m$$

where

Q = oil flow rate [mm³/h]

d_m = bearing mean diameter
= $0,5 (d + D)$ [mm]

The calculated oil flow rate should be verified during operation and adjusted, depending on the resulting temperatures.

Oil-air lubrication method

In some precision applications, the high operational speeds and requisite low operating temperatures generally require an oil-air lubrication system. With the oil-air method, also called the oil-spot method, accurately metered quantities of oil are directed at each individual bearing by compressed air. For bearings used in sets, each bearing is supplied by a separate oil injector. Most designs include special spacers that incorporate the oil nozzles.

Diagram 2

Graphic representation of a running-in procedure

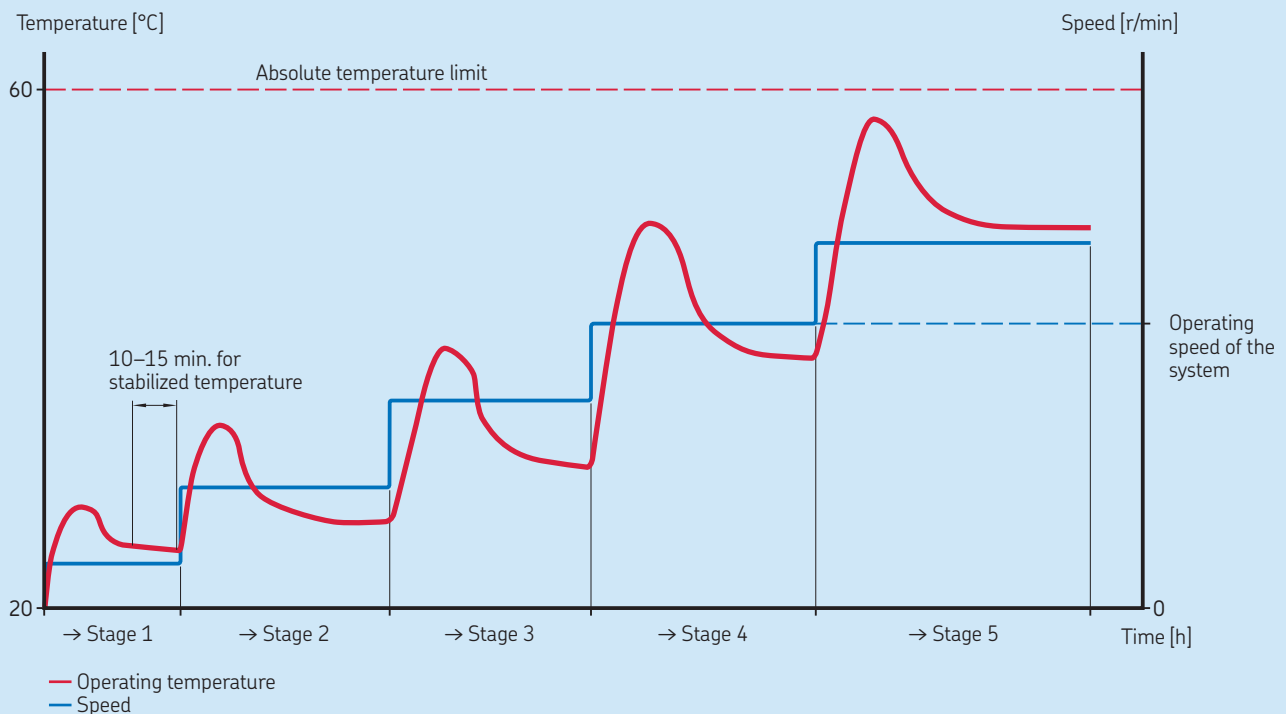

Oil is supplied to the feed lines at given intervals by a metering unit. The oil coats the inside surface of the feed lines and “creeps” toward the nozzles (→ fig. 1), where it is delivered to the bearings. The oil nozzles should be positioned correctly (→ table 3) to make sure that the oil is introduced into the contact area between the balls and raceways and to avoid interference with the cage.

High quality lubricating oils without EP additives are generally recommended for super-precision angular contact ball bearings. Oils with a viscosity of 40 to 100 mm²/s at 40 °C are typically used. A filter that prevents particles > 5 μm from reaching the bearings should also be incorporated.

Oil jet lubrication method

For very high speed operation, a sufficient but not excessive amount of oil should be supplied to the bearing to provide adequate lubrication, without increasing the operating temperature unnecessarily. One particularly efficient method of achieving this is the oil jet method, common in high-speed turbochargers, where a jet of oil under high pressure is directed at the side of the bearing. The velocity of the oil jet should be sufficiently high (at least 15 m/s) to penetrate the turbulence surrounding the rotating bearing. It is important that the oil leaving the bearing can be discharged from the arrangement by adequately dimensioned ducts.

Table 3

Oil nozzle position for oil-air lubrication

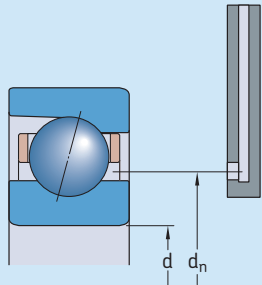

Bearing Bore diameter d	Size	Oil nozzle position d _n
mm	–	mm
7	7	13,6
8	8	14,3
9	9	16,3
10	00	18,3
12	01	20
15	02	23
17	03	25,9
20	04	31,1
25	05	36,1
30	06	42,7
35	07	49,7
40	08	56,2
45	09	60,6
50	10	65,6
55	11	72,6
60	12	80,1
65	13	86,6
70	14	91,6
75	15	96,6
80	16	103,4
85	17	111,5
90	18	117,5
95	19	124,4
100	20	131,4
105	21	138,4
110	22	145,9
120	24	158,2
130	26	170,7
140	28	184,8

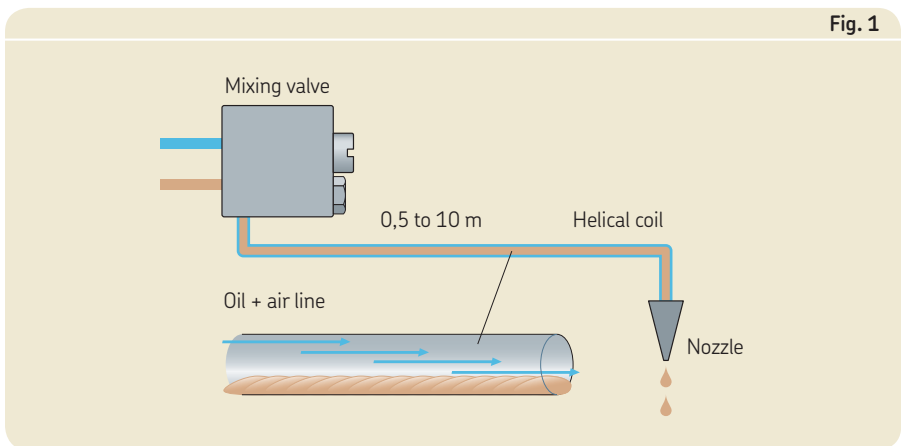

Bearing data – general

Boundary dimensions

The boundary dimensions of bearings in the 72 .. D (E 200) series are in accordance with ISO 15:2011, for dimension series O2.

Chamfer dimensions

Minimum values for the chamfer dimensions in the radial direction (r_1, r_3) and the axial direction (r_2, r_4) are provided in the product tables. The values for the chamfers on the inner ring and thrust side of the outer ring are in accordance with ISO 15:2011. The values for the non-thrust side of the outer ring are in accordance with ISO 12044:1995, where applicable.

The appropriate maximum chamfer limits are in accordance with ISO 582:1995.

Tolerances

Bearings in the 72 .. D (E 200) series are manufactured, standard, to P4A tolerance class. On request, bearings can be supplied to the higher precision PA9A tolerance class.

The tolerance values are listed as follows:

- P4A (better than ABEC 7) tolerance class in **table 1**
- PA9A (better than ABEC 9) tolerance class in **table 2**

The tolerance symbols used in these tables are listed together with their definitions in **table 3**, on **page 20**.

Bearing preload

A single super-precision angular contact ball bearing does not have any preload. Preload can only be obtained when one bearing is placed against another to provide location in the opposite direction.

Table 1

Class P4A tolerances

Inner ring

d	over	incl.	Δ_{dmp}	high	low	Δ_{ds}	high	low	V_{dp}	max	V_{dmp}	max	Δ_{Bs}	high	low	Δ_{B1s}	high	low	V_{Bs}	max	K_{ia}	max	S_d	max	S_{ia}	max
mm			μm			μm			μm		μm		μm			μm			μm		μm		μm		μm	
2,5	10		0	-4		0	-4		1,5		1		0	-40		0	-250		1,5		1,5		1,5		1,5	
10	18		0	-4		0	-4		1,5		1		0	-80		0	-250		1,5		1,5		1,5		1,5	
18	30		0	-5		0	-5		1,5		1		0	-120		0	-250		1,5		2,5		1,5		2,5	
30	50		0	-6		0	-6		1,5		1		0	-120		0	-250		1,5		2,5		1,5		2,5	
50	80		0	-7		0	-7		2		1,5		0	-150		0	-250		1,5		2,5		1,5		2,5	
80	120		0	-8		0	-8		2,5		1,5		0	-200		0	-380		2,5		2,5		2,5		2,5	
120	150		0	-10		0	-10		6		3		0	-250		0	-380		4		4		4		4	

Outer ring

D	over	incl.	Δ_{Dmp}	high	low	Δ_{Ds}	high	low	V_{Dp}	max	V_{Dmp}	max	$\Delta_{Cs}, \Delta_{C1s}$	V_{Cs}	max	K_{ea}	max	S_D	max	S_{ea}	max
mm			μm			μm			μm		μm			μm		μm		μm		μm	
18	30		0	-5		0	-5		2		1,5		Values are identical to those for the inner ring of the same bearing ($\Delta_{Bs}, \Delta_{B1s}$)	1,5		1,5		1,5		1,5	
30	50		0	-6		0	-6		2		1,5			1,5		2,5		1,5		1,5	
50	80		0	-7		0	-7		2		1,5			1,5		4		1,5		4	
80	120		0	-8		0	-8		2,5		1,5			2,5		5		2,5		5	
120	150		0	-9		0	-9		4		1,5		2,5		5		2,5		5		
150	180		0	-10		0	-10		6		3		4		6		4		6		
180	250		0	-11		0	-11		6		4		5		8		5		8		

Preload in sets of universally matchable bearings and matched bearing sets prior to mounting

Universally matchable bearings and matched bearing sets are manufactured so that when the bearings are placed against each other, prior to mounting, a certain preload will result.

To meet the varying requirements regarding rotational speed and rigidity, bearings in the 72 .. D (E 200) series are produced to four different preload classes:

- class A, extra light preload
- class B, light preload
- class C, moderate preload
- class D, heavy preload

The preload level depends on the contact angle and the size of the bearing, and applies to bearing sets with two bearings arranged back-to-back or face-to-face as listed in **table 4**, on **page 21**.

Bearing sets consisting of three or four bearings have a heavier preload than sets with two bearings. The preload for these bearing sets is obtained by multiplying the

values listed in **table 4**, on **page 21** by a factor of:

- 1,35 for TBT (*TD*) and TFT (*TF*) arrangements
- 1,6 for QBT (*3TD*) and QFT (*3TF*) arrangements
- 2 for QBC (*TDT*) and QFC (*TFT*) arrangements

Bearing sets with a special preload can be supplied on request. These bearing sets are identified by the designation suffix G followed by a number. The number is the mean preload value of the set expressed in daN. Special preload is not applicable for sets of universally matchable bearings consisting of three or more bearings (suffixes TG and QG).

Preload in mounted bearing sets

Sets of universally matchable bearings and matched bearing sets have a heavier preload when mounted compared to the built-in preload, predetermined during manufacture. The increase in preload

depends mainly on the actual tolerances for the bearing seats on the shaft and in the housing bore. An increase in preload can also be caused by deviations from the geometrical form of associated components such as cylindricity, perpendicularity or concentricity of the bearing seats.

During operation, an increase in preload is also caused by:

- the rotational speed of the shaft for constant position arrangements
- temperature gradients between the inner ring, outer ring and balls
- different coefficient of thermal expansion for the shaft and housing materials compared to the bearing steel

If the bearings are mounted with zero interference on a steel shaft and in a thick-walled steel or cast iron housing, preload can be determined with sufficient accuracy from

$$G_m = f_1 f_2 f_{HC} G_{A,B,C,D}$$

Table 2

Class PA9A tolerances

Inner ring		Δ_{dmp}		Δ_{ds}		V_{dp}	V_{dmp}	Δ_{Bs}		Δ_{B1s}		V_{Bs}	K_{ia}	S_d	S_{ia}
over	incl.	high	low	high	low	max	max	high	low	high	low	max	max	max	max
mm		μm		μm		μm	μm	μm		μm		μm	μm	μm	μm
2,5	10	0	-2,5	0	-2,5	1,5	1	0	-40	0	-250	1,5	1,5	1,5	1,5
10	18	0	-2,5	0	-2,5	1,5	1	0	-80	0	-250	1,5	1,5	1,5	1,5
18	30	0	-2,5	0	-2,5	1,5	1	0	-120	0	-250	1,5	2,5	1,5	2,5
30	50	0	-2,5	0	-2,5	1,5	1	0	-120	0	-250	1,5	2,5	1,5	2,5
50	80	0	-4	0	-4	2	1,5	0	-150	0	-250	1,5	2,5	1,5	2,5
80	120	0	-5	0	-5	2,5	1,5	0	-200	0	-380	2,5	2,5	2,5	2,5
120	150	0	-7	0	-7	4	3	0	-250	0	-380	2,5	2,5	2,5	2,5
Outer ring		Δ_{Dmp}		Δ_{Ds}		V_{Dp}	V_{Dmp}	$\Delta_{Cs}, \Delta_{C1s}$		V_{Cs}	K_{ea}	S_D	S_{ea}		
over	incl.	high	low	high	low	max	max			max	max	max	max		
mm		μm		μm		μm	μm			μm	μm	μm	μm		
18	30	0	-4	0	-4	2	1,5	Values are identical to those for the inner ring of the same bearing ($\Delta_{Bs}, \Delta_{B1s}$)		1,5	1,5	1,5	1,5		
30	50	0	-4	0	-4	2	1,5			1,5	2,5	1,5	2,5		
50	80	0	-4	0	-4	2	1,5			1,5	4	1,5	4		
80	120	0	-5	0	-5	2,5	1,5			2,5	5	2,5	5		
120	150	0	-5	0	-5	2,5	1,5		2,5	5	2,5	5			
150	180	0	-7	0	-7	4	3		2,5	5	2,5	5			
180	250	0	-8	0	-8	5	4		4	7	4	7			

where

G_m = preload in the mounted bearing set [N]

$G_{A,B,C,D}$ = built-in preload in the bearing set, prior to mounting (→ table 4, on page 21) [N]

f = a bearing factor dependent on the bearing size (→ table 5, on page 21)

f_1 = a correction factor dependent on the contact angle (→ table 6, on page 22)

f_2 = a correction factor dependent on the preload class (→ table 6, on page 22)

f_{HC} = a correction factor for hybrid bearings (→ table 6, on page 22)

Considerably tighter fits may be necessary, for example for very high speed spindles, where centrifugal forces can loosen the inner ring from its seat on the shaft. These bearing arrangements must be carefully evaluated.

Preload with constant force

In precision, high-speed applications, a constant and uniform preload is important. To maintain the proper preload, calibrated linear springs can be used between one bearing outer ring and its housing shoulder (→ fig. 1). With springs, the kinematic behaviour of the bearing will not influence preload under normal operating conditions. Note, however, that a spring-loaded bearing arrangement has a lower degree of rigidity

than an arrangement using axial displacement to set the preload.

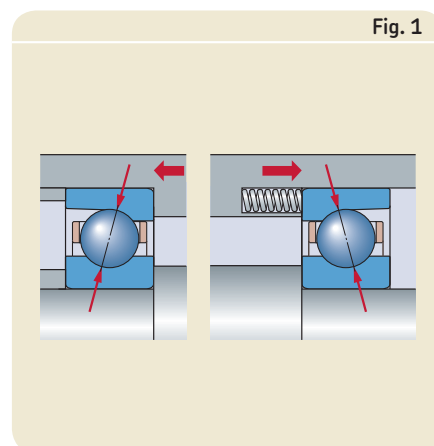

Fig. 1

Table 3

Tolerance symbols

Tolerance symbol **Definition**

Bore diameter

d	Nominal bore diameter
d_s	Single bore diameter
d_{mp}	Mean bore diameter; arithmetical mean of the largest and smallest single bore diameters in one plane
Δ_{d_s}	Deviation of a single bore diameter from the nominal ($\Delta_{d_s} = d_s - d$)
$\Delta_{d_{mp}}$	Deviation of the mean bore diameter from the nominal ($\Delta_{d_{mp}} = d_{mp} - d$)
V_{d_p}	Bore diameter variation; difference between the largest and smallest single bore diameters in one plane
$V_{d_{mp}}$	Mean bore diameter variation; difference between the largest and smallest mean bore diameter

Outside diameter

D	Nominal outside diameter
D_s	Single outside diameter
D_{mp}	Mean outside diameter; arithmetical mean of the largest and smallest single outside diameters in one plane
Δ_{D_s}	Deviation of a single outside diameter from the nominal ($\Delta_{D_s} = D_s - D$)
$\Delta_{D_{mp}}$	Deviation of the mean outside diameter from the nominal ($\Delta_{D_{mp}} = D_{mp} - D$)
V_{D_p}	Outside diameter variation; difference between the largest and smallest single outside diameters in one plane
$V_{D_{mp}}$	Mean outside diameter variation; difference between the largest and smallest mean outside diameter

Tolerance symbol **Definition**

Width

B, C	Nominal width of inner ring and outer ring, respectively
B_s, C_s	Single width of inner ring and outer ring, respectively
B_{1s}, C_{1s}	Single width of inner ring and outer ring, respectively, of a bearing belonging to a matched set
$\Delta_{B_s}, \Delta_{C_s}$	Deviation of single inner ring width or single outer ring width from the nominal ($\Delta_{B_s} = B_s - B$; $\Delta_{C_s} = C_s - C$)
$\Delta_{B_{1s}}, \Delta_{C_{1s}}$	Deviation of single inner ring width or single outer ring width of a bearing belonging to a matched set from the nominal (not valid for universally matchable bearings) ($\Delta_{B_{1s}} = B_{1s} - B$; $\Delta_{C_{1s}} = C_{1s} - C$)
V_{B_s}, V_{C_s}	Ring width variation; difference between the largest and smallest single widths of inner ring and of outer ring, respectively

Running accuracy

K_{ia}, K_{ea}	Radial runout of inner ring and outer ring, respectively, of assembled bearing
S_d	Side face runout with reference to bore (of inner ring)
S_D	Outside inclination variation; variation in inclination of outside cylindrical surface to outer ring side face
S_{ia}, S_{ea}	Axial runout of inner ring and outer ring, respectively, of assembled bearing



Table 4

Axial preload of universally matchable bearings and matched bearing pairs, prior to mounting, arranged back-to-back or face-to-face

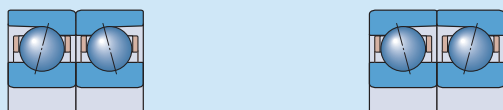

Bearing Bore diameter	Size	Axial preload of bearings in the series ¹⁾ 72 CD (E 200 CE1) 72 CD/HC (E 200 /NS CE1) for preload class				72 ACD (E 200 CE3) 72 ACD/HC (E 200 /NS CE3) for preload class			
		A	B	C	D	A	B	C	D
d	–	N							
mm	–	N							
7	7	12	24	48	96	18	36	72	144
8	8	14	28	56	112	22	44	88	176
9	9	15	30	60	120	25	50	100	200
10	00	17	34	68	136	27	54	108	216
12	01	22	44	88	176	35	70	140	280
15	02	30	60	120	240	45	90	180	360
17	03	35	70	140	280	60	120	240	480
20	04	45	90	180	360	70	140	280	560
25	05	50	100	200	400	80	160	320	640
30	06	90	180	360	720	150	300	600	1 200
35	07	120	240	480	960	190	380	760	1 520
40	08	125	250	500	1 000	200	400	800	1 600
45	09	160	320	640	1 280	260	520	1 040	2 080
50	10	170	340	680	1 360	265	530	1 060	2 120
55	11	210	420	840	1 680	330	660	1 320	2 640
60	12	215	430	860	1 720	350	700	1 400	2 800
65	13	250	500	1 000	2 000	400	800	1 600	3 200
70	14	260	520	1 040	2 080	420	840	1 680	3 360
75	15	270	540	1 080	2 160	430	860	1 720	3 440
80	16	320	640	1 280	2 560	520	1 040	2 080	4 160
85	17	370	740	1 480	2 960	600	1 200	2 400	4 800
90	18	480	960	1 920	3 840	750	1 500	3 000	6 000
95	19	520	1 040	2 080	4 160	850	1 700	3 400	6 800
100	20	590	1 180	2 360	4 720	950	1 900	3 800	7 600
105	21	650	1 300	2 600	5 200	1 000	2 000	4 000	8 000
110	22	670	1 340	2 680	5 360	1 050	2 100	4 200	8 400
120	24	750	1 500	3 000	6 000	1 200	2 400	4 800	9 600
130	26	810	1 620	3 240	6 480	1 300	2 600	5 200	10 400
140	28	850	1 700	3 400	6 800	1 350	2 700	5 400	10 800

¹⁾ Data is also applicable to sealed bearings.

Table 5

Bearing factor f for calculating the preload in mounted bearing sets

Bearing Bore diameter	Size	Bearing factor f ¹⁾
d	–	–
mm	–	–
7	7	1,02
8	8	1,02
9	9	1,02
10	00	1,02
12	01	1,02
15	02	1,03
17	03	1,03
20	04	1,03
25	05	1,03
30	06	1,05
35	07	1,05
40	08	1,05
45	09	1,07
50	10	1,08
55	11	1,08
60	12	1,07
65	13	1,07
70	14	1,08
75	15	1,08
80	16	1,09
85	17	1,08
90	18	1,09
95	19	1,09
100	20	1,09
105	21	1,08
110	22	1,08
120	24	1,08
130	26	1,09
140	28	1,09

¹⁾ Data is also applicable to sealed bearings.

Preload by axial displacement

Rigidity and precise axial guidance are critical parameters in bearing arrangements, especially when alternating axial forces occur. In these cases, the preload in the bearings is usually obtained by adjusting the bearing rings relative to each other in the axial direction. This preload method offers significant benefits in terms of system rigidity. However, depending on the contact angle and ball material, preload increases considerably with rotational speed.

Universally matchable bearings and matched bearing sets are manufactured so that when mounted properly, they will attain their predetermined axial displacement and consequently the proper preload. With single bearings, precision-matched spacer rings must be used.

Adjusting preload with spacer rings

By placing precision-matched spacer rings between two bearings, it is possible to increase or decrease preload. Precision-matched spacer rings can also be used to:

- increase system rigidity
- create a sufficiently large grease reservoir between two bearings
- create a space for oil-air lubrication nozzles

It is possible to adjust preload in a bearing set by grinding the side face of the inner or outer spacer ring. **Table 7** provides information about which of the equal-width spacer ring side faces must be ground and what effect it will have. Guideline values for the requisite overall width reduction of the spacer rings are listed in **table 8**.

To achieve maximum bearing performance, the spacer rings must not deform under load. They should be made of high-grade steel that can be hardened to between 45 and 60 HRC. Particular importance must be given to the plane parallelism of the side face surfaces, where the permissible shape deviation must not exceed 1 to 2 μm .

Effect of rotational speed on preload

Using strain gauges, SKF has determined that there is a marked increase in preload at very high speeds. This is mainly attributable

to the heavy centrifugal forces on the balls causing them to change their position within the bearing. When compared to an all-steel bearing, a hybrid bearing can attain much higher rotational speeds without significantly increasing preload. This is due to the lower mass of the balls.

Bearing axial stiffness

Axial stiffness depends on the deformation of the bearing under load and can be expressed as the ratio of the load to bearing resilience. However, since there is not a direct linear relation between bearing resilience and load, constant values for axial stiffness cannot be quoted. Exact values of axial stiffness, for bearings in the 72 .. D (E 200) series, for a given preload can be calculated using advanced computer methods, but guideline values are listed in **table 9**, on **page 24**. These values apply to mounted bearing sets under static conditions with

two all-steel bearings arranged back-to-back or face-to-face and subjected to moderate loads.

Bearing sets comprising three or four bearings can provide a higher degree of axial stiffness than sets with two bearings. The axial stiffness for these sets can be calculated by multiplying the values listed in **table 9**, on **page 24**, by a factor dependent on the bearing arrangement:

- 1,45 for TBT (TD) and TFT (TF) arrangements
- 1,8 for QBT (3TD) and QFT (3TF) arrangements
- 2 for QBC (TDT) and QFC (TFT) arrangements

For hybrid bearings, the axial stiffness can be calculated in the same way as for all-steel bearings. However, the calculated value should then be multiplied by a factor of 1,11 (for all arrangements and preload classes).

Table 6

Correction factors for calculating the preload in mounted bearing sets

Bearing series ¹⁾	Correction factors					f_{HC}
	f_1	f_2 for preload class				
		A	B	C	D	
72 CD (E 200 CE1)	1	1	1,01	1,03	1,05	1
72 ACD (E 200 CE3)	0,99	1	1,01	1,02	1,05	1
72 CD/HC (E 200 /NS CE1)	1	1	1,01	1,03	1,06	1,01
72 ACD/HC (E 200 /NS CE3)	0,99	1	1,01	1,03	1,06	1,01

¹⁾ Data is also applicable to sealed bearings.

Table 7

Guidelines for spacer ring modification

Preload change of a bearing set	Width reduction Value	Requisite spacer ring between bearings arranged	
		back-to-back	face-to-face
Increasing the preload			
from A to B	a	inner	outer
from B to C	b	inner	outer
from C to D	c	inner	outer
from A to C	a + b	inner	outer
from A to D	a + b + c	inner	outer
Decreasing the preload			
from B to A	a	outer	inner
from C to B	b	outer	inner
from D to C	c	outer	inner
from C to A	a + b	outer	inner
from D to A	a + b + c	outer	inner

Table 8

Guideline values for spacer ring width reduction

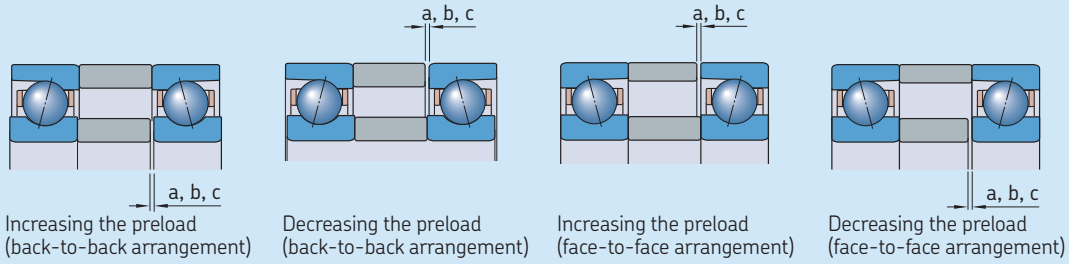

Bearing Bore diameter d	Size	Requisite spacer ring width reduction for bearings in the series ¹⁾						
		72 CD (E 200 CE1)			72 ACD (E 200 CE3)			
		a	b	c	a	b	c	
mm	—	μm						
7	7	4	5	8	2	4	6	
8	8	4	6	9	3	4	7	
9	9	4	6	9	3	4	7	
10	00	4	6	9	3	4	7	
12	01	5	7	10	3	5	7	
15	02	6	8	12	4	5	8	
17	03	6	9	13	4	6	10	
20	04	6	10	14	4	6	10	
25	05	6	10	14	4	6	10	
30	06	8	11	16	5	8	12	
35	07	9	13	19	6	9	14	
40	08	9	13	19	6	9	14	
45	09	10	15	21	7	10	16	
50	10	10	15	21	7	10	16	
55	11	11	16	24	7	11	18	
60	12	11	16	24	7	11	18	
65	13	12	18	26	8	13	19	
70	14	12	18	26	8	13	19	
75	15	12	18	26	8	13	19	
80	16	13	19	28	9	14	21	
85	17	14	21	30	9	14	22	
90	18	16	24	37	11	17	26	
95	19	17	26	38	12	18	28	
100	20	19	28	40	12	19	30	
105	21	19	29	42	13	20	30	
110	22	19	29	42	13	20	30	
120	24	21	31	45	14	21	33	
130	26	21	31	45	14	21	33	
140	28	21	31	45	14	21	33	

¹⁾ Data is also applicable to sealed bearings.

Fitting and clamping of bearing rings

Super-precision angular contact ball bearings are typically located axially on shafts or in housings with either precision lock nuts (→ fig. 2) or end caps. These components require high geometrical precision and good mechanical strength to provide reliable locking.

The tightening torque M_t for precision lock nuts or end cap bolts, must be sufficient to prevent relative movement of adjacent components, maintain the position of the

bearings without deformation, and minimize material fatigue.

Calculating the tightening torque M_t

It is difficult to accurately calculate the tightening torque M_t for a precision lock nut or the bolts in an end cap. The following formulas can be used to do the calculations, but the results should be verified during operation.

Fig. 2

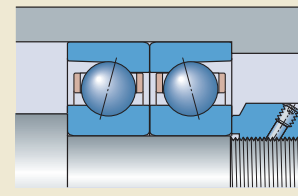
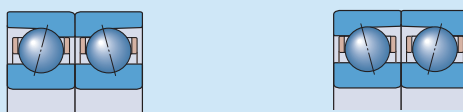

Table 9

Static axial stiffness for bearing pairs arranged back-to-back or face-to-face



Bearing Bore diameter d mm	Size	Static axial stiffness of all-steel bearings in the series ¹⁾ 72 CD (E 200 CE1) for preload class				72 ACD (E 200 CE3) for preload class			
		A	B	C	D	A	B	C	D
		N/μm							
7	7	11	15	21	30	27	35	46	61
8	8	12	15	21	30	28	36	48	63
9	9	13	17	23	33	32	41	54	71
10	00	14	19	26	37	35	45	59	78
12	01	16	22	30	42	41	52	68	90
15	02	19	26	35	49	46	60	78	102
17	03	21	28	38	53	53	68	89	118
20	04	25	33	45	63	61	79	102	135
25	05	29	38	52	72	71	92	119	158
30	06	43	59	82	118	105	137	181	244
35	07	50	67	94	136	119	154	204	275
40	08	53	71	100	143	127	165	218	294
45	09	61	82	115	166	146	190	252	341
50	10	65	88	124	178	154	201	266	359
55	11	72	98	137	197	172	224	296	399
60	12	75	102	142	205	182	238	315	424
65	13	78	106	148	212	189	245	324	437
70	14	83	112	156	225	201	261	345	464
75	15	87	118	165	237	211	274	361	487
80	16	96	130	181	260	257	303	401	540
85	17	102	139	193	278	250	325	429	578
90	18	114	154	215	314	273	355	469	632
95	19	115	156	217	313	280	365	482	649
100	20	122	165	230	331	296	388	509	685
105	21	129	174	243	349	308	399	527	708
110	22	135	183	254	364	325	423	557	748
120	24	139	188	261	373	338	440	579	777
130	26	155	209	291	416	378	491	630	869
140	28	163	220	305	437	397	516	679	911

¹⁾ Data is also applicable to sealed bearings.

The axial clamping force for a precision lock nut or the bolts in an end cap is

$$P_a = F_s + (N_{cp}F_c) + G_{A,B,C,D}$$

The tightening torque for a precision lock nut is

$$M_t = K P_a \\ = K [F_s + (N_{cp}F_c) + G_{A,B,C,D}]$$

The tightening torque for end cap bolts is

$$M_t = \frac{K P_a}{N_b}$$

$$M_t = \frac{K [F_s + (N_{cp}F_c) + G_{A,B,C,D}]}{N_b}$$

where

M_t = tightening torque [Nmm]

P_a = axial clamping force [N]

F_s = minimum axial clamping force (→ table 10) [N]

F_c = axial fitting force (→ table 10) [N]

$G_{A,B,C,D}$ = built-in bearing preload, prior to mounting (→ table 4 on page 21) [N]

N_{cp} = the number of preloaded bearings

N_b = the number of end cap bolts

K = a calculation factor dependent on the thread (→ table 11)

Load carrying capacity of bearing sets

The values listed in the product tables for the basic dynamic load rating C , the basic static load rating C_0 and the fatigue load limit P_u apply to single bearings. For bearing sets, the values for single bearings should be multiplied by a calculation factor according to table 12 on page 27.

C

Table 10

Minimum axial clamping force and axial fitting force for precision lock nuts and end caps

Bearing Bore diameter d	Size	Minimum axial clamping force F_s	Axial fitting force F_c
mm	–	N	
7	7	490	550
8	8	490	600
9	9	650	600
10	00	850	700
12	01	1 000	700
15	02	950	600
17	03	1 300	700
20	04	2 300	850
25	05	2 400	750
30	06	3 400	700
35	07	5 500	1 200
40	08	6 000	1 200
45	09	7 000	1 200
50	10	6 000	1 000
55	11	7 500	1 100
60	12	11 000	1 300
65	13	13 000	1 300
70	14	14 000	1 300
75	15	15 000	1 300
80	16	17 000	1 900
85	17	19 000	2 500
90	18	19 000	2 500
95	19	27 000	3 000
100	20	27 000	3 100
105	21	31 000	3 300
110	22	37 000	3 600
120	24	45 000	4 300
130	26	48 000	4 500
140	28	59 000	5 000

Table 11

Factor K for calculating the tightening torque

Nominal thread diameter ¹⁾	Factor K	
	for precision lock nuts	end cap bolts
–	–	–
M 4	–	0,8
M 5	–	1
M 6	–	1,2
M 8	–	1,6
M 10	1,4	2
M 12	1,6	2,4
M 14	1,9	2,7
M 15	2	2,9
M 16	2,1	3,1
M 17	2,2	–
M 20	2,6	–
M 25	3,2	–
M 30	3,9	–
M 35	4,5	–
M 40	5,1	–
M 45	5,8	–
M 50	6,4	–
M 55	7	–
M 60	7,6	–
M 65	8,1	–
M 70	9	–
M 75	9,6	–
M 80	10	–
M 85	11	–
M 90	11	–
M 95	12	–
M 100	12	–
M 105	13	–
M 110	14	–
M 120	15	–
M 130	16	–
M 140	17	–

¹⁾ Applicable for fine threads only

Equivalent bearing loads

When determining the equivalent bearing load, the preload must be taken into account. Depending on the operating conditions, the requisite axial component of the bearing load F_a for a bearing pair arranged back-to-back or face-to-face can be approximated using the following equations.

For bearing pairs under radial load and mounted with an interference fit

$$F_a = G_m$$

For bearing pairs under radial load and preloaded using springs

$$F_a = G_{A,B,C,D}$$

For bearing pairs under axial load and mounted with an interference fit

$$F_a = G_m + 0,67 K_a \quad \text{for } K_a \leq 3 G_m$$

$$F_a = K_a \quad \text{for } K_a > 3 G_m$$

For bearing pairs under axial load and preloaded using springs

$$F_a = G_{A,B,C,D} + K_a$$

where

- F_a = axial component of the load [N]
- $G_{A,B,C,D}$ = built-in preload of the bearing pair, prior to mounting (\rightarrow **table 4** on **page 21**) [N]
- G_m = preload in the mounted bearing pair (\rightarrow *Preload in mounted bearing sets*, **page 19**) [N]
- K_a = external axial force acting on a single bearing [N]

Equivalent dynamic bearing load

For single bearings and bearings paired in tandem

$$P = F_r \quad \text{for } F_a/F_r \leq e$$

$$P = X F_r + Y F_a \quad \text{for } F_a/F_r > e$$

For bearing pairs, arranged back-to-back or face-to-face

$$P = F_r + Y_1 F_a \quad \text{for } F_a/F_r \leq e$$

$$P = X F_r + Y_2 F_a \quad \text{for } F_a/F_r > e$$

where

- P = equivalent dynamic load of the bearing set [kN]
- F_r = radial component of the load acting on the bearing set [kN]
- F_a = axial component of the load acting on the bearing set [kN]

The values for the calculation factors e , X , Y , Y_1 and Y_2 depend on the bearing contact angle and are listed in **tables 13** and **14**. For bearings with a 15° contact angle, the factors also depend on the relationship $f_0 F_a / C_0$ where f_0 is the calculation factor and C_0 is the basic static load rating, both of which are listed in the product tables.

Equivalent static bearing load

For single bearings and bearings paired in tandem

$$P_0 = 0,5 F_r + Y_0 F_a$$

For bearing pairs, arranged back-to-back or face-to-face

$$P_0 = F_r + Y_0 F_a$$

where

- P_0 = equivalent static load of the bearing set [kN]
- F_r = radial component of the load acting on the bearing set [kN]
- F_a = axial component of the load acting on the bearing set [kN]

If $P_0 < F_r$, $P_0 = F_r$ should be used. The values for the calculation factor Y_0 depend on the bearing contact angle and are listed in **tables 13** and **14**.

Attainable speeds

The attainable speeds listed in the product tables should be regarded as guideline values. They are valid for single bearings under light load ($P \leq 0,05 C$) that are lightly preloaded using springs. In addition, good heat dissipation from the bearing arrangement is a prerequisite. As there is no friction generated at the seal lip, the attainable speed of a sealed bearing is equivalent to a comparably sized open bearing.

The values provided for oil lubrication apply to the oil-air lubrication method and should be reduced if other oil lubrication methods are used. The values provided for

grease lubrication are maximum values that can be attained with sealed bearings or open bearings with good lubricating grease that has a low consistency and low viscosity. Sealed bearings in the S72 .. D (*E 200/S*) series are designed for high-speed operation i.e. for a speed factor A up to 1 200 000 mm/min.

If single bearings are adjusted against each other with heavier preload or if bearing sets are used, the attainable speeds listed in the product tables should be reduced i.e. the values should be multiplied by a reduction factor. Values for this reduction factor, which depend on the bearing arrangement and preload class, are listed in **table 15**.

If the rotational speed obtained is not sufficient for the application, precision-matched spacer rings in the bearing set can be used to significantly increase the speed capability.

Cages

Depending on their size, bearings in the 72 .. D (*E 200*) series are fitted, standard, with a one-piece outer ring shoulder-guided cage made of one of the following materials:

Standard cages are not identified in the bearing designation. Bearings that have a PEEK cage are marked in the product tables by a footnote.



Fig. 3

- fabric reinforced phenolic resin, which can withstand temperatures up to 120 °C
- carbon fibre reinforced polyetheretherketone (PEEK), which can withstand temperatures up to 150 °C (→ fig. 3)

Seals

The integral seals in sealed S72 .. D (E 200/S) series bearings are designed for a speed factor A up to 1 200 000 mm/min. The permissible operating temperature range of the seals is –25 to +100 °C and up to 120 °C for brief periods.

Materials

The rings and balls of all-steel bearings in the 72 .. D (E 200) series are made from SKF Grade 3 steel, in accordance with ISO 683-17:1999. Balls of hybrid bearings are made of bearing grade silicon nitride Si₃N₄.

The integral seals in sealed bearings are made of an oil- and wear-resistant acrylonitrile-butadiene rubber (NBR) and are reinforced with sheet steel.

Heat treatment

SKF super-precision bearings undergo a special heat treatment to achieve a good balance between hardness and dimensional stability. The hardness of the rings and rolling elements of bearings in the 72 .. D (E 200) series is optimized for wear-resistance and the rings are heat stabilized to accommodate temperatures up to 150 °C.

Table 12

Calculation factors for load carrying capacities of bearing sets

Number of bearings	Calculation factor for		
	C	C ₀	P _u
2	1,62	2	2
3	2,16	3	3
4	2,64	4	4

Table 13

Calculation factors for single bearings and bearings paired in tandem

f ₀ F _a /C ₀	Calculation factors			
	e	X	Y	Y ₀
For 15° contact angle designation suffix CD (1)				
≤ 0,178	0,38	0,44	1,47	0,46
0,357	0,4	0,44	1,4	0,46
0,714	0,43	0,44	1,3	0,46
1,07	0,46	0,44	1,23	0,46
1,43	0,47	0,44	1,19	0,46
2,14	0,5	0,44	1,12	0,46
3,57	0,55	0,44	1,02	0,46
≥ 5,35	0,56	0,44	1	0,46
For 25° contact angle designation suffix ACD (3)				
–	0,68	0,41	0,87	0,38

Table 14

Calculation factors for bearing pairs arranged back-to-back or face-to-face

2 f ₀ F _a /C ₀	Calculation factors				
	e	X	Y ₁	Y ₂	Y ₀
For 15° contact angle designation suffix CD (1)					
≤ 0,178	0,38	0,72	1,65	2,39	0,92
0,357	0,4	0,72	1,57	2,28	0,92
0,714	0,43	0,72	1,46	2,11	0,92
1,07	0,46	0,72	1,38	2	0,92
1,43	0,47	0,72	1,34	1,93	0,92
2,14	0,5	0,72	1,26	1,82	0,92
3,57	0,55	0,72	1,14	1,66	0,92
≥ 5,35	0,56	0,72	1,12	1,63	0,92
For 25° contact angle designation suffix ACD (3)					
–	0,68	0,67	0,92	1,41	0,76

Table 15

Speed reduction factors for bearing sets

Number of bearings	Arrangement	Designation suffix for matched sets	Speed reduction factor for preload class			
			A	B	C	D
2	Back-to-back	DB (DD)	0,81	0,75	0,65	0,40
	Face-to-face	DF (FF)	0,77	0,72	0,61	0,36
3	Back-to-back and tandem	TBT (TD)	0,7	0,63	0,49	0,25
	Face-to-face and tandem	TFT (TF)	0,63	0,56	0,42	0,17
4	Tandem back-to-back	QBC (TDT)	0,64	0,6	0,53	0,32
	Tandem face-to-face	QFC (TFT)	0,62	0,58	0,48	0,27

Note: For spring-loaded tandem sets, designation suffix DT (T), a speed reduction factor of 0,9 should be applied.

Marking of bearings and bearing sets

Each bearing in the 72 .. D (E 200) series has various identifiers on the external surfaces of the rings. The position of the identifiers may differ between open and sealed bearings. Open bearings are marked as follows (→ **fig. 4**):

- 1 SKF trademark
- 2 Complete designation of the bearing
- 3 Country of manufacture
- 4 Date of manufacture, coded
- 5 Deviation of the mean outside diameter, Δ_{Dm} [μm], and position of the maximum eccentricity of the outer ring
- 6 Deviation of the mean bore diameter, Δ_{dm} [μm], and position of the maximum eccentricity of the inner ring
- 7 Thrust face mark, punched
- 8 Serial number (bearing sets only)
- 9 "V-shaped" marking (matched bearing sets only)

"V-shaped" marking

A "V-shaped" marking on the outside surface of the outer rings of matched bearing sets indicates how the bearings should be mounted to obtain the proper preload in the set. The marking also indicates how the bearing set should be mounted in relation to the axial load. The "V-shaped" marking should point in the direction in which the axial load will act on the inner ring (→ **fig. 5**). In applications where there are axial loads in both directions, the "V-shaped" marking should point toward the greater of the two loads.

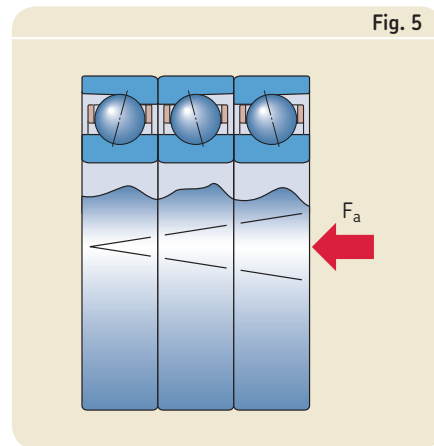

Fig. 5

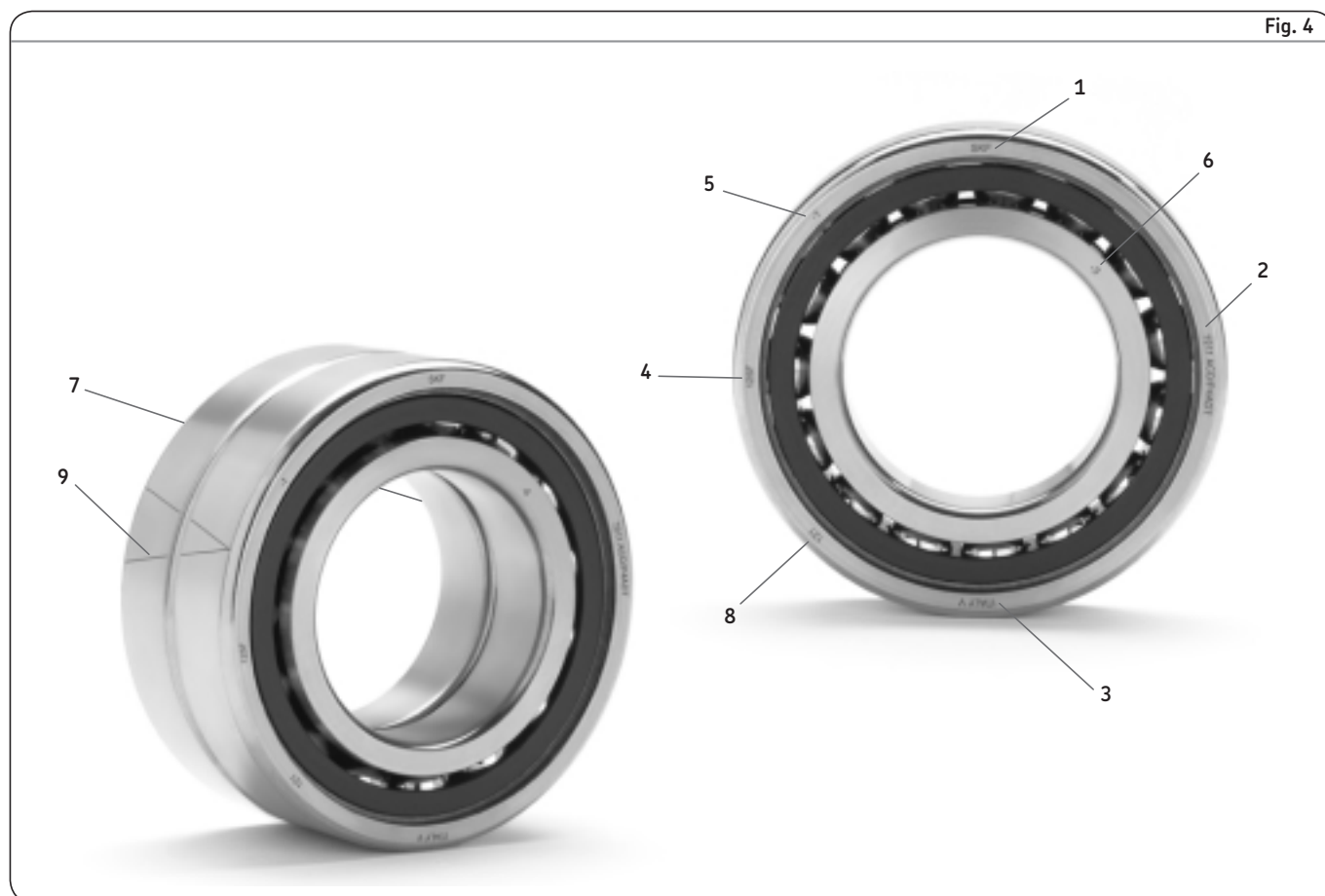

Fig. 4

Packaging

SKF super-precision bearings are distributed in new SKF illustrated boxes (→ **fig. 6**). An instruction sheet, with information about mounting bearing sets, is supplied in each box.

Designation system

The designations for SKF bearings in the 72 .. D (*E 200*) series are provided in **table 16** on **page 30** together with their definitions.



Designation system for SKF super-precision angular contact ball bearings in the 72 .. D (E 200) series

Single bearing: 7214 ACDGA/HCP4A		72	14	ACD	GA	/	HC	P4A		
	Variant prefix	Series	Size	Contact angle and design	Execution and preload (single bearing)		Ball material	Tolerance class	Arrangement	Preload
Matched bearing set: S7220 CD/PA9AQB CD	S	72	20	CD		/		PA9A	QBC	D

Sealing

- Open bearing (no designation prefix)
- S Sealed bearing

Bearing series

- 72 In accordance with ISO dimension series 02

Bearing size

- 7 7 mm bore diameter
- 8 8 mm bore diameter
- 9 9 mm bore diameter
- 00 10 mm bore diameter
- 01 12 mm bore diameter
- 02 15 mm bore diameter
- 03 17 mm bore diameter
- 04 (x5) 20 mm bore diameter
- to
- 28 (x5) 140 mm bore diameter

Contact angle and internal design

- CD 15° contact angle, high-capacity basic design
- ACD 25° contact angle, high-capacity basic design

Single bearing – execution and preload¹⁾

- Single bearing (no designation suffix)
- GA Single, universally matchable, for extra light preload
- GB Single, universally matchable, for light preload
- GC Single, universally matchable, for moderate preload
- GD Single, universally matchable, for heavy preload

Cage

- Fabric reinforced phenolic resin or carbon fibre reinforced PEEK, outer ring centred (no designation suffix)

Ball material

- Carbon chromium steel (no designation suffix)
- HC Bearing grade silicon nitride Si₃N₄ (hybrid bearings)

Tolerance class

- P4A Dimensional accuracy in accordance with ISO tolerance class 4, running accuracy better than ISO tolerance class 4
- PA9A Dimensional and running accuracy better than ABMA tolerance class ABEC 9

Bearing set – arrangement

- DB Two bearings arranged back-to-back <>
- DF Two bearings arranged face-to-face ><
- DT Two bearings arranged in tandem <<
- DG Two bearings for universal matching
- TBT Three bearings arranged back-to-back and tandem <>>
- TFT Three bearings arranged face-to-face and tandem >><<
- TT Three bearings arranged in tandem <<<
- TG Three bearings for universal matching
- QBC Four bearings arranged tandem back-to-back <<>>
- QFC Four bearings arranged tandem face-to-face >><<
- QBT Four bearings arranged back-to-back and tandem <>>>
- QFT Four bearings arranged face-to-face and tandem >><<<
- QT Four bearings arranged in tandem <<<<
- QG Four bearings for universal matching

Bearing set – preload¹⁾

- A Extra light preload
- B Light preload
- C Moderate preload
- D Heavy preload
- G... Special preload, expressed in daN e.g. G240

¹⁾ Equivalence between preload classes of SKF and SNFA bearings has to be evaluated in each case as it depends on the bearing size and arrangement. For additional information, contact the SKF application engineering service.

Table 16

Former SNFA designation system for super-precision angular contact ball bearings in the 72 .. D (E 200) series

Single bearing: E 270 /NS 7CE3 UL	E 2(00)	70	/NS	7	CE	3	U	L
	Series and design	Size	Variant	Tolerance class	Cage	Contact angle	Arrangement	Preload
Matched bearing set: E 200/100 /S 9CE1 TDTM	E 200	/100	/S	9	CE	1	TDT	M

Bearing series and internal design

E 200 In accordance with ISO dimension series O2, high-capacity E 200 design

Bearing size

7 7 mm bore diameter
to
95 95 mm bore diameter
/100 100 mm bore diameter
to
/140 140 mm bore diameter

Variant

– Open bearing (no designation suffix)
/S Sealed bearing²⁾
– Carbon chromium steel balls (no designation suffix)
/NS Bearing grade silicon nitride Si₃N₄ balls (hybrid bearings)

Tolerance class

7 Dimensional and running accuracy in accordance with ABMA tolerance class ABEC 7
9 Dimensional and running accuracy in accordance with ABMA tolerance class ABEC 9

CageCE Fabric reinforced phenolic resin, outer ring centred³⁾**Contact angle**

1 15° contact angle
3 25° contact angle

Single bearing – execution and preload¹⁾

– Single bearing (no designation suffix)
UL Single, universally matchable, for light preload
UM Single, universally matchable, for moderate preload
UF Single, universally matchable, for heavy preload

Bearing set – arrangement

DD Two bearings arranged back-to-back <>
FF Two bearings arranged face-to-face ><
T Two bearings arranged in tandem <<
DU Two bearings for universal matching
TD Three bearings arranged back-to-back and tandem <>>
TF Three bearings arranged face-to-face and tandem >><<
3T Three bearings arranged in tandem <<<
TU Three bearings for universal matching
TDT Four bearings arranged tandem back-to-back <<>>
TFT Four bearings arranged tandem face-to-face >><<<
3TD Four bearings arranged back-to-back and tandem <>>>
3TF Four bearings arranged face-to-face and tandem >><<<
4T Four bearings arranged in tandem <<<<
4U Four bearings for universal matching

Bearing set – preload¹⁾

L Light preload (for symmetrical sets only)
M Moderate preload (for symmetrical sets only)
F Heavy preload (for symmetrical sets only)
..daN Special preload (for asymmetrical sets TD, TF, 3TD, 3TF and for special preload executions)

²⁾ Sealed variant not included in previous SNFA assortment.³⁾ PEEK cage not included in previous SNFA assortment.

Super-precision angular contact ball bearings

d 7 – 15 mm

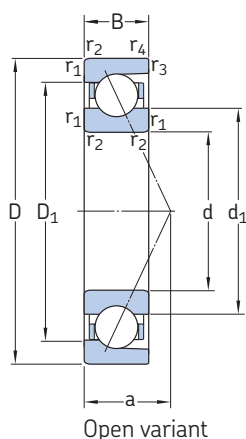

Open variant

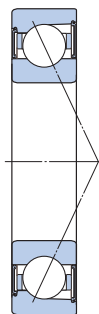

Sealed variant

Principal dimensions			Basic load ratings dynamic static		Fatigue load limit	Calculation factor	Attainable speeds when lubricating with grease oil-air		Mass	Designations SKF	SNFA
d	D	B	C	C ₀	P _u	f ₀					
mm			kN		kN	–	r/min		kg	–	
7	22	7	2,96	1,16	0,049	8,4	80 000	120 000	0,013	727 CD/P4A	E 207 7CE1
	22	7	2,96	1,16	0,049	8,4	95 000	150 000	0,012	727 CD/HCP4A	E 207 /NS 7CE1
	22	7	2,91	1,12	0,048	–	70 000	110 000	0,013	727 ACD/P4A	E 207 7CE3
	22	7	2,91	1,12	0,048	–	85 000	130 000	0,012	727 ACD/HCP4A	E 207 /NS 7CE3
8	24	8	3,71	1,37	0,057	7,9	70 000	110 000	0,017	728 CD/P4A	E 208 7CE1
	24	8	3,71	1,37	0,057	7,9	85 000	130 000	0,015	728 CD/HCP4A	E 208 /NS 7CE1
	24	8	3,58	1,34	0,057	–	67 000	100 000	0,017	728 ACD/P4A	E 208 7CE3
	24	8	3,58	1,34	0,057	–	75 000	120 000	0,015	728 ACD/HCP4A	E 208 /NS 7CE3
9	26	8	4,10	1,66	0,071	8,3	67 000	100 000	0,020	729 CD/P4A	E 209 7CE1
	26	8	4,10	1,66	0,071	8,3	80 000	120 000	0,018	729 CD/HCP4A	E 209 /NS 7CE1
	26	8	3,97	1,6	0,067	–	60 000	90 000	0,020	729 ACD/P4A	E 209 7CE3
	26	8	3,97	1,6	0,067	–	70 000	110 000	0,018	729 ACD/HCP4A	E 209 /NS 7CE3
10	30	9	4,49	1,93	0,08	8,8	60 000	90 000	0,032	7200 CD/P4A	E 210 7CE1
	30	9	4,49	1,93	0,08	8,8	60 000	–	0,032	S7200 CD/P4A	E 210 /S 7CE1
	30	9	4,49	1,93	0,08	8,8	70 000	100 000	0,029	7200 CD/HCP4A	E 210 /NS 7CE1
	30	9	4,49	1,93	0,08	8,8	70 000	–	0,029	S7200 CD/HCP4A	E 210 /S/NS 7CE1
	30	9	4,36	1,86	0,078	–	53 000	80 000	0,032	7200 ACD/P4A	E 210 7CE3
	30	9	4,36	1,86	0,078	–	53 000	–	0,032	S7200 ACD/P4A	E 210 /S 7CE3
	30	9	4,36	1,86	0,078	–	63 000	95 000	0,029	7200 ACD/HCP4A	E 210 /NS 7CE3
	30	9	4,36	1,86	0,078	–	63 000	–	0,029	S7200 ACD/HCP4A	E 210 /S/NS 7CE3
	12	32	10	5,85	2,55	0,108	8,5	53 000	80 000	0,037	7201 CD/P4A ¹⁾
32		10	5,85	2,55	0,108	8,5	53 000	–	0,038	S7201 CD/P4A ¹⁾	E 212 /S 7CE1
32		10	5,85	2,55	0,108	8,5	67 000	95 000	0,033	7201 CD/HCP4A ¹⁾	E 212 /NS 7CE1
32		10	5,85	2,55	0,108	8,5	67 000	–	0,034	S7201 CD/HCP4A ¹⁾	E 212 /S/NS 7CE1
32		10	5,72	2,45	0,104	–	48 000	70 000	0,037	7201 ACD/P4A ¹⁾	E 212 7CE3
32		10	5,72	2,45	0,104	–	48 000	–	0,038	S7201 ACD/P4A ¹⁾	E 212 /S 7CE3
32		10	5,72	2,45	0,104	–	56 000	85 000	0,033	7201 ACD/HCP4A ¹⁾	E 212 /NS 7CE3
32		10	5,72	2,45	0,104	–	56 000	–	0,034	S7201 ACD/HCP4A ¹⁾	E 212 /S/NS 7CE3
15	35	11	7,41	3,35	0,14	8,5	48 000	70 000	0,043	7202 CD/P4A ¹⁾	E 215 7CE1
	35	11	7,41	3,35	0,14	8,5	48 000	–	0,044	S7202 CD/P4A ¹⁾	E 215 /S 7CE1
	35	11	7,41	3,35	0,14	8,5	60 000	85 000	0,037	7202 CD/HCP4A ¹⁾	E 215 /NS 7CE1
	35	11	7,41	3,35	0,14	8,5	60 000	–	0,038	S7202 CD/HCP4A ¹⁾	E 215 /S/NS 7CE1
	35	11	7,15	3,2	0,134	–	43 000	63 000	0,043	7202 ACD/P4A ¹⁾	E 215 7CE3
	35	11	7,15	3,2	0,134	–	43 000	–	0,044	S7202 ACD/P4A ¹⁾	E 215 /S 7CE3
	35	11	7,15	3,2	0,134	–	50 000	75 000	0,037	7202 ACD/HCP4A ¹⁾	E 215 /NS 7CE3
	35	11	7,15	3,2	0,134	–	50 000	–	0,038	S7202 ACD/HCP4A ¹⁾	E 215 /S/NS 7CE3

¹⁾ Indicates a PEEK cage as standard, otherwise the cage is phenolic resin.

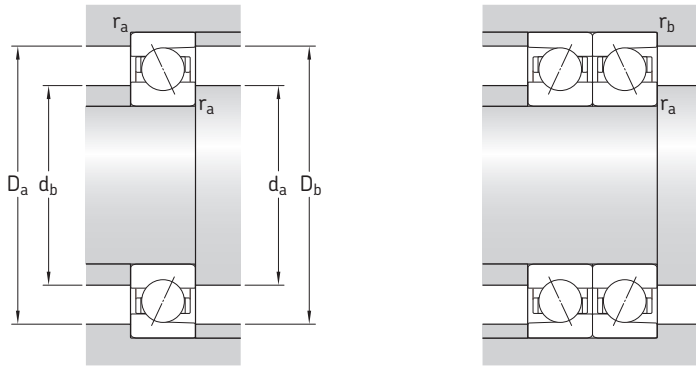

Dimensions

Abutment and fillet dimensions

d	d ₁ ~	D ₁ ~	r _{1,2} min	r _{3,4} min	a	d _{a,d_b} min	D _a max	D _b max	r _a max	r _b max
mm						mm				
7	12,6	17,4	0,3	0,2	6	9,4	19,6	20,2	0,3	0,2
	12,6	17,4	0,3	0,2	6	9,4	19,6	20,2	0,3	0,2
	12,6	17,4	0,3	0,2	7	9,4	19,6	20,2	0,3	0,2
	12,6	17,4	0,3	0,2	7	9,4	19,6	20,2	0,3	0,2
8	13,1	18,9	0,3	0,2	6	10,4	21,6	22,2	0,3	0,2
	13,1	18,9	0,3	0,2	6	10,4	21,6	22,2	0,3	0,2
	13,1	18,9	0,3	0,2	8	10,4	21,6	22,2	0,3	0,2
	13,1	18,9	0,3	0,2	8	10,4	21,6	22,2	0,3	0,2
9	15,1	20,9	0,3	0,2	6	11,4	23,6	24,2	0,3	0,2
	15,1	20,9	0,3	0,2	6	11,4	23,6	24,2	0,3	0,2
	15,1	20,9	0,3	0,2	8	11,4	23,6	24,2	0,3	0,2
	15,1	20,9	0,3	0,2	8	11,4	23,6	24,2	0,3	0,2
10	17,3	23,1	0,6	0,3	7	14,2	25,8	27,6	0,6	0,3
	17,3	24,3	0,6	0,3	7	14,2	25,8	27,6	0,6	0,3
	17,3	23,1	0,6	0,3	7	14,2	25,8	27,6	0,6	0,3
	17,3	24,3	0,6	0,3	7	14,2	25,8	27,6	0,6	0,3
	17,3	23,1	0,6	0,3	7	14,2	25,8	27,6	0,6	0,3
	17,3	24,3	0,6	0,3	9	14,2	25,8	27,6	0,6	0,3
	17,3	23,1	0,6	0,3	9	14,2	25,8	27,6	0,6	0,3
	17,3	24,3	0,6	0,3	9	14,2	25,8	27,6	0,6	0,3
12	18,6	25,4	0,6	0,3	8	16,2	27,8	29,6	0,6	0,3
	18,6	26,6	0,6	0,3	8	16,2	27,8	29,6	0,6	0,3
	18,6	25,4	0,6	0,3	8	16,2	27,8	29,6	0,6	0,3
	18,6	26,6	0,6	0,3	8	16,2	27,8	29,6	0,6	0,3
	18,6	25,4	0,6	0,3	10	16,2	27,8	29,6	0,6	0,3
	18,6	26,6	0,6	0,3	10	16,2	27,8	29,6	0,6	0,3
	18,6	25,4	0,6	0,3	10	16,2	27,8	29,6	0,6	0,3
	18,6	26,6	0,6	0,3	10	16,2	27,8	29,6	0,6	0,3
15	21,4	29,1	0,6	0,3	9	19,2	30,8	32,6	0,6	0,3
	21,4	30,7	0,6	0,3	9	19,2	30,8	32,6	0,6	0,3
	21,4	29,1	0,6	0,3	9	19,2	30,8	32,6	0,6	0,3
	21,4	30,7	0,6	0,3	9	19,2	30,8	32,6	0,6	0,3
	21,4	29,1	0,6	0,3	12	19,2	30,8	32,6	0,6	0,3
	21,4	30,7	0,6	0,3	12	19,2	30,8	32,6	0,6	0,3
	21,4	29,1	0,6	0,3	12	19,2	30,8	32,6	0,6	0,3
	21,4	30,7	0,6	0,3	12	19,2	30,8	32,6	0,6	0,3

Super-precision angular contact ball bearings

d 17 – 35 mm

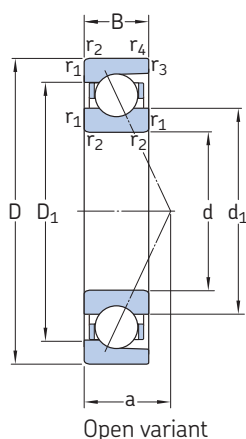

Open variant

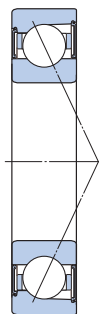

Sealed variant

Principal dimensions			Basic load ratings dynamic static		Fatigue load limit	Calculation factor	Attainable speeds when lubricating with grease oil-air		Mass	Designations SKF	SNFA
d	D	B	C	C ₀	P _u	f ₀					
mm			kN		kN	–	r/min		kg	–	
17	40	12	9,23	4,15	0,176	8,5	43 000	63 000	0,063	7203 CD/P4A ¹⁾	E 217 7CE1
	40	12	9,23	4,15	0,176	8,5	43 000	–	0,065	S7203 CD/P4A ¹⁾	E 217 /S 7CE1
	40	12	9,23	4,15	0,176	8,5	53 000	75 000	0,054	7203 CD/HCP4A ¹⁾	E 217 /NS 7CE1
	40	12	9,23	4,15	0,176	8,5	53 000	–	0,056	S7203 CD/HCP4A ¹⁾	E 217 /S/NS 7CE1
	40	12	8,84	4	0,17	–	38 000	56 000	0,063	7203 ACD/P4A ¹⁾	E 217 7CE3
	40	12	8,84	4	0,17	–	38 000	–	0,065	S7203 ACD/P4A ¹⁾	E 217 /S 7CE3
	40	12	8,84	4	0,17	–	45 000	67 000	0,054	7203 ACD/HCP4A ¹⁾	E 217 /NS 7CE3
	40	12	8,84	4	0,17	–	45 000	–	0,056	S7203 ACD/HCP4A ¹⁾	E 217 /S/NS 7CE3
20	47	14	11,9	5,85	0,245	8,7	36 000	53 000	0,10	7204 CD/P4A ¹⁾	E 220 7CE1
	47	14	11,9	5,85	0,245	8,7	36 000	–	0,11	S7204 CD/P4A ¹⁾	E 220 /S 7CE1
	47	14	11,9	5,85	0,245	8,7	43 000	60 000	0,090	7204 CD/HCP4A ¹⁾	E 220 /NS 7CE1
	47	14	11,9	5,85	0,245	8,7	43 000	–	0,092	S7204 CD/HCP4A ¹⁾	E 220 /S/NS 7CE1
	47	14	11,4	5,6	0,236	–	32 000	48 000	0,10	7204 ACD/P4A ¹⁾	E 220 7CE3
	47	14	11,4	5,6	0,236	–	32 000	–	0,11	S7204 ACD/P4A ¹⁾	E 220 /S 7CE3
	47	14	11,4	5,6	0,236	–	38 000	56 000	0,090	7204 ACD/HCP4A ¹⁾	E 220 /NS 7CE3
	47	14	11,4	5,6	0,236	–	38 000	–	0,092	S7204 ACD/HCP4A ¹⁾	E 220 /S/NS 7CE3
25	52	15	13,5	7,2	0,305	9,1	30 000	45 000	0,13	7205 CD/P4A ¹⁾	E 225 7CE1
	52	15	13,5	7,2	0,305	9,1	30 000	–	0,13	S7205 CD/P4A ¹⁾	E 225 /S 7CE1
	52	15	13,5	7,2	0,305	9,1	38 000	53 000	0,11	7205 CD/HCP4A ¹⁾	E 225 /NS 7CE1
	52	15	13,5	7,2	0,305	9,1	38 000	–	0,11	S7205 CD/HCP4A ¹⁾	E 225 /S/NS 7CE1
	52	15	13	6,95	0,29	–	26 000	40 000	0,13	7205 ACD/P4A ¹⁾	E 225 7CE3
	52	15	13	6,95	0,29	–	26 000	–	0,13	S7205 ACD/P4A ¹⁾	E 225 /S 7CE3
	52	15	13	6,95	0,29	–	32 000	48 000	0,11	7205 ACD/HCP4A ¹⁾	E 225 /NS 7CE3
	52	15	13	6,95	0,29	–	32 000	–	0,11	S7205 ACD/HCP4A ¹⁾	E 225 /S/NS 7CE3
30	62	16	24,2	16	0,67	14	24 000	38 000	0,20	7206 CD/P4A ¹⁾	E 230 7CE1
	62	16	24,2	16	0,67	14	24 000	–	0,20	S7206 CD/P4A ¹⁾	E 230 /S 7CE1
	62	16	24,2	16	0,67	14	32 000	45 000	0,17	7206 CD/HCP4A ¹⁾	E 230 /NS 7CE1
	62	16	24,2	16	0,67	14	32 000	–	0,17	S7206 CD/HCP4A ¹⁾	E 230 /S/NS 7CE1
	62	16	23,4	15,3	0,64	–	20 000	34 000	0,20	7206 ACD/P4A ¹⁾	E 230 7CE3
	62	16	23,4	15,3	0,64	–	20 000	–	0,20	S7206 ACD/P4A ¹⁾	E 230 /S 7CE3
	62	16	23,4	15,3	0,64	–	26 000	40 000	0,17	7206 ACD/HCP4A ¹⁾	E 230 /NS 7CE3
	62	16	23,4	15,3	0,64	–	26 000	–	0,17	S7206 ACD/HCP4A ¹⁾	E 230 /S/NS 7CE3
35	72	17	31,9	21,6	0,915	13,9	20 000	34 000	0,29	7207 CD/P4A ¹⁾	E 235 7CE1
	72	17	31,9	21,6	0,915	13,9	20 000	–	0,29	S7207 CD/P4A ¹⁾	E 235 /S 7CE1
	72	17	31,9	21,6	0,915	13,9	26 000	38 000	0,24	7207 CD/HCP4A ¹⁾	E 235 /NS 7CE1
	72	17	31,9	21,6	0,915	13,9	26 000	–	0,25	S7207 CD/HCP4A ¹⁾	E 235 /S/NS 7CE1
	72	17	30,7	20,8	0,88	–	18 000	30 000	0,29	7207 ACD/P4A ¹⁾	E 235 7CE3
	72	17	30,7	20,8	0,88	–	18 000	–	0,29	S7207 ACD/P4A ¹⁾	E 235 /S 7CE3
	72	17	30,7	20,8	0,88	–	20 000	34 000	0,24	7207 ACD/HCP4A ¹⁾	E 235 /NS 7CE3
	72	17	30,7	20,8	0,88	–	20 000	–	0,25	S7207 ACD/HCP4A ¹⁾	E 235 /S/NS 7CE3

¹⁾ Indicates a PEEK cage as standard, otherwise the cage is phenolic resin.

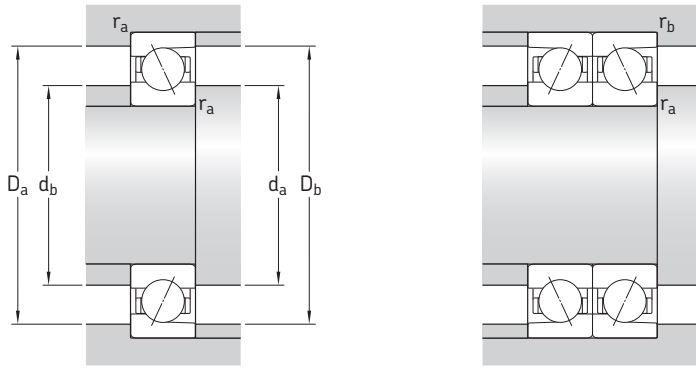

Dimensions

Abutment and fillet dimensions

d	d ₁	D ₁	r _{1,2} min	r _{3,4} min	a	d _{a,d_b} min	D _a max	D _b max	r _a max	r _b max
mm						mm				
17	24,1	32,8	0,6	0,3	10	21,2	35,8	37,6	0,6	0,3
	24,1	34,4	0,6	0,3	10	21,2	35,8	37,6	0,6	0,3
	24,1	32,8	0,6	0,3	10	21,2	35,8	37,6	0,6	0,3
	24,1	34,4	0,6	0,3	10	21,2	35,8	37,6	0,6	0,3
	24,1	32,8	0,6	0,3	13	21,2	35,8	37,6	0,6	0,3
	24,1	34,4	0,6	0,3	13	21,2	35,8	37,6	0,6	0,3
	24,1	32,8	0,6	0,3	13	21,2	35,8	37,6	0,6	0,3
	24,1	34,4	0,6	0,3	13	21,2	35,8	37,6	0,6	0,3
20	29,1	38,7	1	0,3	12	25,6	41,4	44,6	1	0,3
	29,1	40,9	1	0,3	12	25,6	41,4	44,6	1	0,3
	29,1	38,7	1	0,3	12	25,6	41,4	44,6	1	0,3
	29,1	40,9	1	0,3	12	25,6	41,4	44,6	1	0,3
	29,1	38,7	1	0,3	15	25,6	41,4	44,6	1	0,3
	29,1	40,9	1	0,3	15	25,6	41,4	44,6	1	0,3
	29,1	38,7	1	0,3	15	25,6	41,4	44,6	1	0,3
	29,1	40,9	1	0,3	15	25,6	41,4	44,6	1	0,3
25	34,1	43,7	1	0,3	13	30,6	46,4	49,6	1	0,3
	34,1	45,9	1	0,3	13	30,6	46,4	49,6	1	0,3
	34,1	43,7	1	0,3	13	30,6	46,4	49,6	1	0,3
	34,1	45,9	1	0,3	13	30,6	46,4	49,6	1	0,3
	34,1	43,7	1	0,3	17	30,6	46,4	49,6	1	0,3
	34,1	45,9	1	0,3	17	30,6	46,4	49,6	1	0,3
	34,1	43,7	1	0,3	17	30,6	46,4	49,6	1	0,3
	34,1	45,9	1	0,3	17	30,6	46,4	49,6	1	0,3
30	40,2	51,8	1	0,3	14	35,6	56,4	59,6	1	0,3
	40,2	54	1	0,3	14	35,6	56,4	59,6	1	0,3
	40,2	51,8	1	0,3	14	35,6	56,4	59,6	1	0,3
	40,2	54	1	0,3	14	35,6	56,4	59,6	1	0,3
	40,2	51,8	1	0,3	19	35,6	56,4	59,6	1	0,3
	40,2	54	1	0,3	19	35,6	56,4	59,6	1	0,3
	40,2	51,8	1	0,3	19	35,6	56,4	59,6	1	0,3
	40,2	54	1	0,3	19	35,6	56,4	59,6	1	0,3
35	46,8	60,2	1,1	0,3	16	42	65	69,6	1	0,3
	46,8	63,2	1,1	0,3	16	42	65	69,6	1	0,3
	46,8	60,2	1,1	0,3	16	42	65	69,6	1	0,3
	46,8	63,2	1,1	0,3	16	42	65	69,6	1	0,3
	46,8	60,2	1,1	0,3	21	42	65	69,6	1	0,3
	46,8	63,2	1,1	0,3	21	42	65	69,6	1	0,3
	46,8	60,2	1,1	0,3	21	42	65	69,6	1	0,3
	46,8	63,2	1,1	0,3	21	42	65	69,6	1	0,3

Super-precision angular contact ball bearings

d 40 – 60 mm

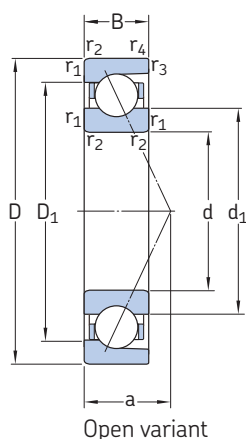

Open variant

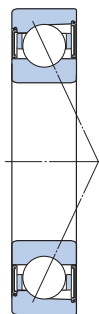

Sealed variant

Principal dimensions			Basic load ratings dynamic static		Fatigue load limit	Calculation factor	Attainable speeds when lubricating with grease oil-air		Mass	Designations SKF	SNFA
d	D	B	C	C ₀	P _u	f ₀					
mm			kN		kN	–	r/min		kg	–	
40	80	18	33,8	24	1,02	14,4	18 000	30 000	0,37	7208 CD/P4A ¹⁾	E 240 7CE1
	80	18	33,8	24	1,02	14,4	18 000	–	0,38	S7208 CD/P4A ¹⁾	E 240 /S 7CE1
	80	18	33,8	24	1,02	14,4	22 000	34 000	0,33	7208 CD/HCP4A ¹⁾	E 240 /NS 7CE1
	80	18	33,8	24	1,02	14,4	22 000	–	0,33	S7208 CD/HCP4A ¹⁾	E 240 /S/NS 7CE1
	80	18	31,9	22,8	0,98	–	16 000	26 000	0,37	7208 ACD/P4A ¹⁾	E 240 7CE3
	80	18	31,9	22,8	0,98	–	16 000	–	0,38	S7208 ACD/P4A ¹⁾	E 240 /S 7CE3
	80	18	31,9	22,8	0,98	–	19 000	32 000	0,33	7208 ACD/HCP4A ¹⁾	E 240 /NS 7CE3
	80	18	31,9	22,8	0,98	–	19 000	–	0,33	S7208 ACD/HCP4A ¹⁾	E 240 /S/NS 7CE3
45	85	19	42,3	31	1,32	14,2	17 000	28 000	0,41	7209 CD/P4A ¹⁾	E 245 7CE1
	85	19	42,3	31	1,32	14,2	17 000	–	0,42	S7209 CD/P4A ¹⁾	E 245 /S 7CE1
	85	19	42,3	31	1,32	14,2	20 000	32 000	0,34	7209 CD/HCP4A ¹⁾	E 245 /NS 7CE1
	85	19	42,3	31	1,32	14,2	20 000	–	0,35	S7209 CD/HCP4A ¹⁾	E 245 /S/NS 7CE1
	85	19	41	30	1,25	–	15 000	24 000	0,41	7209 ACD/P4A ¹⁾	E 245 7CE3
	85	19	41	30	1,25	–	15 000	–	0,42	S7209 ACD/P4A ¹⁾	E 245 /S 7CE3
	85	19	41	30	1,25	–	17 000	28 000	0,34	7209 ACD/HCP4A ¹⁾	E 245 /NS 7CE3
	85	19	41	30	1,25	–	17 000	–	0,35	S7209 ACD/HCP4A ¹⁾	E 245 /S/NS 7CE3
50	90	20	44,9	34	1,43	14,5	16 000	26 000	0,46	7210 CD/P4A ¹⁾	E 250 7CE1
	90	20	44,9	34	1,43	14,5	16 000	–	0,47	S7210 CD/P4A ¹⁾	E 250 /S 7CE1
	90	20	44,9	34	1,43	14,5	19 000	30 000	0,39	7210 CD/HCP4A ¹⁾	E 250 /NS 7CE1
	90	20	44,9	34	1,43	14,5	19 000	–	0,39	S7210 CD/HCP4A ¹⁾	E 250 /S/NS 7CE1
	90	20	42,3	32,5	1,37	–	14 000	22 000	0,46	7210 ACD/P4A ¹⁾	E 250 7CE3
	90	20	42,3	32,5	1,37	–	14 000	–	0,47	S7210 ACD/P4A ¹⁾	E 250 /S 7CE3
	90	20	42,3	32,5	1,37	–	16 000	26 000	0,39	7210 ACD/HCP4A ¹⁾	E 250 /NS 7CE3
	90	20	42,3	32,5	1,37	–	16 000	–	0,39	S7210 ACD/HCP4A ¹⁾	E 250 /S/NS 7CE3
55	100	21	55,3	43	1,8	14,5	14 000	22 000	0,61	7211 CD/P4A ¹⁾	E 255 7CE1
	100	21	55,3	43	1,8	14,5	14 000	–	0,62	S7211 CD/P4A ¹⁾	E 255 /S 7CE1
	100	21	55,3	43	1,8	14,5	17 000	26 000	0,51	7211 CD/HCP4A ¹⁾	E 255 /NS 7CE1
	100	21	55,3	43	1,8	14,5	17 000	–	0,52	S7211 CD/HCP4A ¹⁾	E 255 /S/NS 7CE1
	100	21	52,7	40,5	1,73	–	13 000	20 000	0,61	7211 ACD/P4A ¹⁾	E 255 7CE3
	100	21	52,7	40,5	1,73	–	13 000	–	0,62	S7211 ACD/P4A ¹⁾	E 255 /S 7CE3
	100	21	52,7	40,5	1,73	–	15 000	24 000	0,51	7211 ACD/HCP4A ¹⁾	E 255 /NS 7CE3
	100	21	52,7	40,5	1,73	–	15 000	–	0,52	S7211 ACD/HCP4A ¹⁾	E 255 /S/NS 7CE3
60	110	22	57,2	46,5	2	14,9	13 000	20 000	0,81	7212 CD/P4A ¹⁾	E 260 7CE1
	110	22	57,2	46,5	2	14,9	13 000	–	0,82	S7212 CD/P4A ¹⁾	E 260 /S 7CE1
	110	22	57,2	46,5	2	14,9	16 000	24 000	0,69	7212 CD/HCP4A ¹⁾	E 260 /NS 7CE1
	110	22	57,2	46,5	2	14,9	16 000	–	0,71	S7212 CD/HCP4A ¹⁾	E 260 /S/NS 7CE1
	110	22	55,3	45	1,9	–	11 000	18 000	0,81	7212 ACD/P4A ¹⁾	E 260 7CE3
	110	22	55,3	45	1,9	–	11 000	–	0,82	S7212 ACD/P4A ¹⁾	E 260 /S 7CE3
	110	22	55,3	45	1,9	–	14 000	22 000	0,69	7212 ACD/HCP4A ¹⁾	E 260 /NS 7CE3
	110	22	55,3	45	1,9	–	14 000	–	0,71	S7212 ACD/HCP4A ¹⁾	E 260 /S/NS 7CE3

¹⁾ Indicates a PEEK cage as standard, otherwise the cage is phenolic resin.

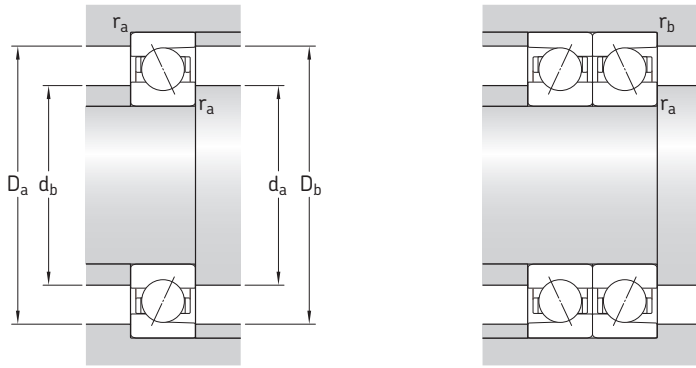

Dimensions

Abutment and fillet dimensions

d	d ₁	D ₁	r _{1,2} min	r _{3,4} min	a	d _{a,d_b} min	D _a max	D _b max	r _a max	r _b max
mm						mm				
40	53,3	66,7	1,1	0,6	17	47	73	75,8	1	0,6
	53,3	69,7	1,1	0,6	17	47	73	75,8	1	0,6
	53,3	66,7	1,1	0,6	17	47	73	75,8	1	0,6
	53,3	69,7	1,1	0,6	17	47	73	75,8	1	0,6
	53,3	66,7	1,1	0,6	23	47	73	75,8	1	0,6
	53,3	69,7	1,1	0,6	23	47	73	75,8	1	0,6
	53,3	66,7	1,1	0,6	23	47	73	75,8	1	0,6
	53,3	69,7	1,1	0,6	23	47	73	75,8	1	0,6
45	57,3	72,7	1,1	0,6	18	52	78	80,8	1	0,6
	57,3	75,7	1,1	0,6	18	52	78	80,8	1	0,6
	57,3	72,7	1,1	0,6	18	52	78	80,8	1	0,6
	57,3	75,7	1,1	0,6	18	52	78	80,8	1	0,6
	57,3	72,7	1,1	0,6	25	52	78	80,8	1	0,6
	57,3	75,7	1,1	0,6	25	52	78	80,8	1	0,6
	57,3	72,7	1,1	0,6	25	52	78	80,8	1	0,6
	57,3	75,7	1,1	0,6	25	52	78	80,8	1	0,6
50	62,3	77,7	1,1	0,6	19	57	83	85,8	1	0,6
	62,3	80,7	1,1	0,6	19	57	83	85,8	1	0,6
	62,3	77,7	1,1	0,6	19	57	83	85,8	1	0,6
	62,3	80,7	1,1	0,6	19	57	83	85,8	1	0,6
	62,3	77,7	1,1	0,6	26	57	83	85,8	1	0,6
	62,3	80,7	1,1	0,6	26	57	83	85,8	1	0,6
	62,3	77,7	1,1	0,6	26	57	83	85,8	1	0,6
	62,3	80,7	1,1	0,6	26	57	83	85,8	1	0,6
55	68,9	86,1	1,5	0,6	21	64	91	95,8	1,5	0,6
	68,9	89,1	1,5	0,6	21	64	91	95,8	1,5	0,6
	68,9	86,1	1,5	0,6	21	64	91	95,8	1,5	0,6
	68,9	89,1	1,5	0,6	21	64	91	95,8	1,5	0,6
	68,9	86,1	1,5	0,6	29	64	91	95,8	1,5	0,6
	68,9	89,1	1,5	0,6	29	64	91	95,8	1,5	0,6
	68,9	86,1	1,5	0,6	29	64	91	95,8	1,5	0,6
	68,9	89,1	1,5	0,6	29	64	91	95,8	1,5	0,6
60	76,4	93,6	1,5	0,6	22	69	101	105,8	1,5	0,6
	76,4	96,8	1,5	0,6	22	69	101	105,8	1,5	0,6
	76,4	93,6	1,5	0,6	22	69	101	105,8	1,5	0,6
	76,4	96,8	1,5	0,6	22	69	101	105,8	1,5	0,6
	76,4	93,6	1,5	0,6	31	69	101	105,8	1,5	0,6
	76,4	96,8	1,5	0,6	31	69	101	105,8	1,5	0,6
	76,4	93,6	1,5	0,6	31	69	101	105,8	1,5	0,6
	76,4	96,8	1,5	0,6	31	69	101	105,8	1,5	0,6

Super-precision angular contact ball bearings

d 65 – 90 mm

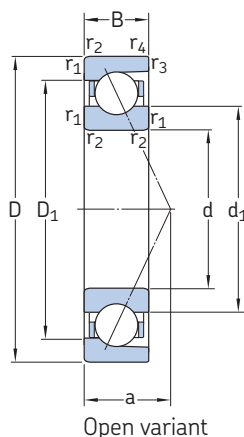

Open variant

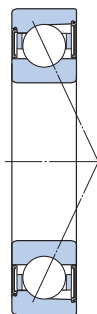

Sealed variant

Principal dimensions			Basic load ratings dynamic static		Fatigue load limit	Calculation factor	Attainable speeds when lubricating with grease oil-air		Mass	Designations SKF	SNFA
d	D	B	C	C ₀	P _u	f ₀					
mm			kN		kN	–	r/min		kg	–	
65	120	23	66,3	53	2,28	14,6	12 000	19 000	1,05	7213 CD/P4A ¹⁾	E 265 7CE1
	120	23	66,3	53	2,28	14,6	12 000	–	1,05	S7213 CD/P4A ¹⁾	E 265 /S 7CE1
	120	23	66,3	53	2,28	14,6	15 000	22 000	0,88	7213 CD/HCP4A ¹⁾	E 265 /NS 7CE1
	120	23	66,3	53	2,28	14,6	15 000	–	0,88	S7213 CD/HCP4A ¹⁾	E 265 /S/NS 7CE1
	120	23	63,7	51	2,2	–	10 000	17 000	1,05	7213 ACD/P4A ¹⁾	E 265 7CE3
	120	23	63,7	51	2,2	–	10 000	–	1,05	S7213 ACD/P4A ¹⁾	E 265 /S 7CE3
	120	23	63,7	51	2,2	–	13 000	20 000	0,88	7213 ACD/HCP4A ¹⁾	E 265 /NS 7CE3
	120	23	63,7	51	2,2	–	13 000	–	0,88	S7213 ACD/HCP4A ¹⁾	E 265 /S/NS 7CE3
70	125	24	68,9	58,5	2,45	14,8	11 000	18 000	1,10	7214 CD/P4A	E 270 7CE1
	125	24	68,9	58,5	2,45	14,8	11 000	–	1,15	S7214 CD/P4A	E 270 /S 7CE1
	125	24	68,9	58,5	2,45	14,8	14 000	20 000	0,95	7214 CD/HCP4A	E 270 /NS 7CE1
	125	24	68,9	58,5	2,45	14,8	14 000	–	0,97	S7214 CD/HCP4A	E 270 /S/NS 7CE1
	125	24	66,3	55	2,36	–	9 500	16 000	1,10	7214 ACD/P4A	E 270 7CE3
	125	24	66,3	55	2,36	–	9 500	–	1,15	S7214 ACD/P4A	E 270 /S 7CE3
	125	24	66,3	55	2,36	–	12 000	19 000	0,95	7214 ACD/HCP4A	E 270 /NS 7CE3
	125	24	66,3	55	2,36	–	12 000	–	0,97	S7214 ACD/HCP4A	E 270 /S/NS 7CE3
75	130	25	71,5	62	2,65	15	10 000	17 000	1,20	7215 CD/P4A	E 275 7CE1
	130	25	71,5	62	2,65	15	10 000	–	1,25	S7215 CD/P4A	E 275 /S 7CE1
	130	25	71,5	62	2,65	15	14 000	20 000	1,05	7215 CD/HCP4A	E 275 /NS 7CE1
	130	25	71,5	62	2,65	15	14 000	–	1,05	S7215 CD/HCP4A	E 275 /S/NS 7CE1
	130	25	68,9	58,5	2,5	–	9 000	15 000	1,20	7215 ACD/P4A	E 275 7CE3
	130	25	68,9	58,5	2,5	–	9 000	–	1,25	S7215 ACD/P4A	E 275 /S 7CE3
	130	25	68,9	58,5	2,5	–	11 000	18 000	1,05	7215 ACD/HCP4A	E 275 /NS 7CE3
	130	25	68,9	58,5	2,5	–	11 000	–	1,05	S7215 ACD/HCP4A	E 275 /S/NS 7CE3
80	140	26	85,2	75	3,05	15,1	9 500	16 000	1,45	7216 CD/P4A	E 280 7CE1
	140	26	85,2	75	3,05	15,1	9 500	–	1,50	S7216 CD/P4A	E 280 /S 7CE1
	140	26	85,2	75	3,05	15,1	12 000	18 000	1,25	7216 CD/HCP4A	E 280 /NS 7CE1
	140	26	85,2	75	3,05	15,1	12 000	–	1,30	S7216 CD/HCP4A	E 280 /S/NS 7CE1
	140	26	81,9	72	2,9	–	8 500	14 000	1,45	7216 ACD/P4A	E 280 7CE3
	140	26	81,9	72	2,9	–	8 500	–	1,50	S7216 ACD/P4A	E 280 /S 7CE3
	140	26	81,9	72	2,9	–	10 000	17 000	1,25	7216 ACD/HCP4A	E 280 /NS 7CE3
	140	26	81,9	72	2,9	–	10 000	–	1,30	S7216 ACD/HCP4A	E 280 /S/NS 7CE3
85	150	28	99,5	88	3,45	14,9	9 000	15 000	1,85	7217 CD/P4A	E 285 7CE1
	150	28	99,5	88	3,45	14,9	11 000	17 000	1,55	7217 CD/HCP4A	E 285 /NS 7CE1
	150	28	95,6	85	3,35	–	8 000	13 000	1,85	7217 ACD/P4A	E 285 7CE3
	150	28	95,6	85	3,35	–	9 500	16 000	1,55	7217 ACD/HCP4A	E 285 /NS 7CE3
90	160	30	127	112	4,25	14,6	8 500	14 000	2,25	7218 CD/P4A	E 290 7CE1
	160	30	121	106	4,05	–	7 500	12 000	2,25	7218 ACD/P4A	E 290 7CE3

¹⁾ Indicates a PEEK cage as standard, otherwise the cage is phenolic resin.

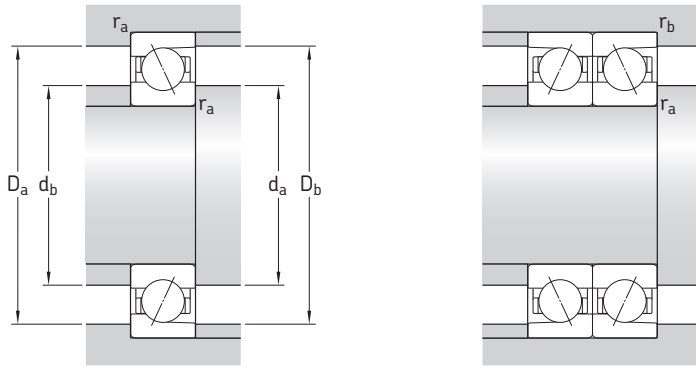

Dimensions

Abutment and fillet dimensions

d	d ₁	D ₁	r _{1,2} min	r _{3,4} min	a	d _{a,d_b} min	D _a max	D _b max	r _a max	r _b max
mm	~	~				mm				
65	82,9	102,1	1,5	0,6	24	74	111	115,8	1,5	0,6
	82,9	105,3	1,5	0,6	24	74	111	115,8	1,5	0,6
	82,9	102,1	1,5	0,6	24	74	111	115,8	1,5	0,6
	82,9	105,3	1,5	0,6	24	74	111	115,8	1,5	0,6
	82,9	102,1	1,5	0,6	33	74	111	115,8	1,5	0,6
	82,9	105,3	1,5	0,6	33	74	111	115,8	1,5	0,6
	82,9	102,1	1,5	0,6	33	74	111	115,8	1,5	0,6
	82,9	105,3	1,5	0,6	33	74	111	115,8	1,5	0,6
70	87,9	107,1	1,5	0,6	25	79	116	120,8	1,5	0,6
	87,9	110,3	1,5	0,6	25	79	116	120,8	1,5	0,6
	87,9	107,1	1,5	0,6	25	79	116	120,8	1,5	0,6
	87,9	110,3	1,5	0,6	25	79	116	120,8	1,5	0,6
	87,9	107,1	1,5	0,6	35	79	116	120,8	1,5	0,6
	87,9	110,3	1,5	0,6	35	79	116	120,8	1,5	0,6
	87,9	107,1	1,5	0,6	35	79	116	120,8	1,5	0,6
	87,9	110,3	1,5	0,6	35	79	116	120,8	1,5	0,6
75	92,9	112,1	1,5	0,6	26	84	121	125,8	1,5	0,6
	92,9	115,3	1,5	0,6	26	84	121	125,8	1,5	0,6
	92,9	112,1	1,5	0,6	26	84	121	125,8	1,5	0,6
	92,9	115,3	1,5	0,6	26	84	121	125,8	1,5	0,6
	92,9	112,1	1,5	0,6	37	84	121	125,8	1,5	0,6
	92,9	115,3	1,5	0,6	37	84	121	125,8	1,5	0,6
	92,9	112,1	1,5	0,6	37	84	121	125,8	1,5	0,6
	92,9	115,3	1,5	0,6	37	84	121	125,8	1,5	0,6
80	99,5	120,5	2	1	28	91	129	134,4	2	1
	99,5	124,3	2	1	28	91	129	134,4	2	1
	99,5	120,5	2	1	28	91	129	134,4	2	1
	99,5	124,3	2	1	28	91	129	134,4	2	1
	99,5	120,5	2	1	39	91	129	134,4	2	1
	99,5	124,3	2	1	39	91	129	134,4	2	1
	99,5	120,5	2	1	39	91	129	134,4	2	1
	99,5	124,3	2	1	39	91	129	134,4	2	1
85	106,5	129,5	2	1	30	96	139	144,4	2	1
	106,5	129,5	2	1	30	96	139	144,4	2	1
	106,5	129,5	2	1	42	96	139	144,4	2	1
	106,5	129,5	2	1	42	96	139	144,4	2	1
90	111,6	138,4	2	1	32	101	149	154,4	2	1
	111,6	138,4	2	1	44	101	149	154,4	2	1

Super-precision angular contact ball bearings

d 95 – 140 mm

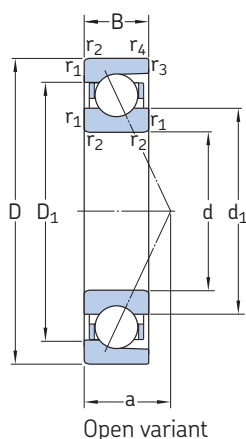

Open variant

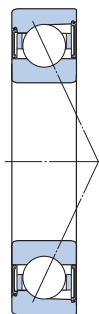

Sealed variant

Principal dimensions			Basic load ratings dynamic static		Fatigue load limit	Calculation factor	Attainable speeds when lubricating with grease oil-air		Mass	Designations SKF	SNFA
d	D	B	C	C ₀	P _u	f ₀					
mm			kN		kN	–	r/min		kg	–	
95	170	32	138	120	4,40	14,6	8 000	13 000	2,70	7219 CD/P4A	E 295 7CE1
	170	32	133	114	4,25	–	7 500	12 000	2,70	7219 ACD/P4A	E 295 7CE3
100	180	34	156	137	4,9	14,5	7 500	12 000	3,25	7220 CD/P4A	E 200/100 7CE1
	180	34	148	129	4,65	–	7 000	11 000	3,25	7220 ACD/P4A	E 200/100 7CE3
105	190	36	172	153	5,3	14,5	7 500	12 000	3,85	7221 CD/P4A	E 200/105 7CE1
	190	36	163	146	5,1	–	6 700	10 000	3,85	7221 ACD/P4A	E 200/105 7CE3
110	200	38	178	166	5,6	14,7	7 000	11 000	4,65	7222 CD/P4A	E 200/110 7CE1
	200	38	168	160	5,4	–	6 700	10 000	4,65	7222 ACD/P4A	E 200/110 7CE3
120	215	40	199	193	6,3	14,6	6 700	10 000	5,40	7224 CD/P4A	E 200/120 7CE1
	215	40	190	183	6	–	6 000	9 000	5,40	7224 ACD/P4A	E 200/120 7CE3
130	230	40	216	224	6,95	14,9	6 300	9 500	6,35	7226 CD/P4A	E 200/130 7CE1
	230	40	203	212	6,7	–	5 600	8 500	6,35	7226 ACD/P4A	E 200/130 7CE3
140	250	42	221	240	7,35	15,2	5 600	8 500	8,15	7228 CD/P4A	E 200/140 7CE1
	250	42	212	228	6,95	–	5 000	7 500	8,15	7228 ACD/P4A	E 200/140 7CE3

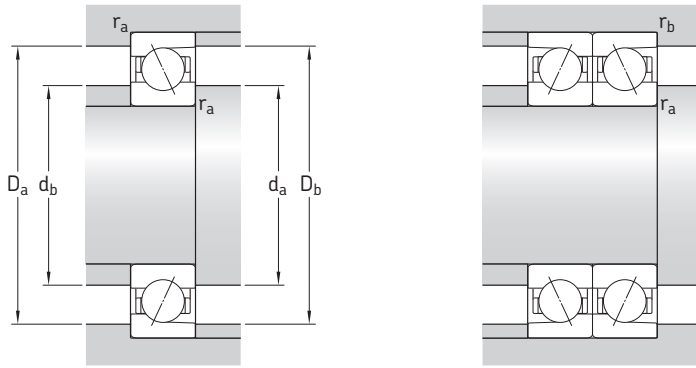

Dimensions

Abutment and fillet dimensions

d	d ₁ ~	D ₁ ~	r _{1,2} min	r _{3,4} min	a	d _{a,d_b} min	D _a max	D _b max	r _a max	r _b max
mm						mm				
95	118,1	146,9	2,1	1,1	34	107	158	163	2,1	1
	118,1	146,9	2,1	1,1	47	107	158	163	2,1	1
100	124,7	155,3	2,1	1,1	36	112	168	173	2,1	1
	124,7	155,3	2,1	1,1	50	112	168	173	2,1	1
105	131,2	163,8	2,1	1,1	38	117	178	183	2,1	1
	131,2	163,8	2,1	1,1	53	117	178	183	2,1	1
110	138,7	171,3	2,1	1,1	40	122	188	193	2,1	1
	138,7	171,3	2,1	1,1	55	122	188	193	2,1	1
120	150,3	186,7	2,1	1,1	43	132	203	208	2,1	1
	150,3	186,7	2,1	1,1	60	132	203	208	2,1	1
130	162,8	199,2	3	1,1	44	144	216	223	2,5	1
	162,8	199,2	3	1,1	62	144	216	223	2,5	1
140	176,9	213,2	3	1,5	47	154	236	241	2,5	1,5
	176,9	213,2	3	1,5	67	154	236	241	2,5	1,5

Setting the highest standard for precision bearings

SKF has developed and is continuing to develop a new, improved generation of super-precision bearings. The new assortment delivers improved accuracy and extended bearing service life when compared to previous designs.

Table 1 on **page 44** and **45** provides an overview of the new assortment of SKF super-precision bearings.

Super-precision angular contact ball bearings

Bearings in the 718 (SEA) series

Bearings in the 718 (SEA) series provide optimum performance in applications where a low cross section and high degree of rigidity, speed and superior accuracy are critical design parameters. They are particularly suitable for machine tool applications, multipindle drilling heads, robotic arms, measuring devices, racing car wheels and other precision applications. The standard assortment accommodates shaft diameters ranging from 10 to 160 mm.



Bearings in the 719 .. D (SEB) and 70 .. D (EX) series

For applications where a high load carrying capacity is an additional operational requirement, SKF offers high-capacity bearings in the 719 .. D (SEB) and 70 .. D (EX) series. The ability of the new design super-precision bearings in these two series to accommodate heavy loads in applications where radial space is often limited, makes them an excellent choice for demanding applications. Open bearings in the 719 .. D (SEB) series accommodate shaft diameters ranging from 10 to 360 mm; sealed bearings from 10 to 150 mm.

Open bearings in the 70 .. D (EX) series accommodate shaft diameters ranging from 6 to 240 mm; sealed bearings from 10 to 150 mm.



Bearings in the S719 .. B (HB .. /S) and S70 .. B (HX .. /S) series

High-speed sealed bearings in the S719 .. B (HB .. /S) and S70 .. B (HX .. /S) series can virtually eliminate the problem of premature bearing failures resulting from contamination. The standard assortment accommodates shaft diameters ranging from 30 to 120 mm. These relubrication-free bearings are particularly suitable for metal cutting and woodworking machines. The bearings are also available in an open variant.



Bearings in the 719 .. E (VEB) and 70 .. E (VEX) series

Compared to high-speed B design bearings, high-speed E design bearings have a higher speed capability and can accommodate heavier loads. This desirable combination makes these bearings an excellent choice for demanding applications.

Open bearings in the 719 .. E (VEB) series accommodate shaft diameters ranging from 8 to 120 mm; sealed bearings from 20 to 120 mm.

Open bearings in the 70 .. E (VEX) series accommodate shaft diameters ranging from 6 to 120 mm; sealed bearings from 10 to 120 mm.

Bearings made from NitroMax steel

In extremely demanding applications such as high-speed machining centres and milling machines, bearings are frequently subjected to difficult operating conditions such as very high speeds, thin-film lubrication conditions, and contaminated and corrosive environments. To enable longer bearing service life and reduce the costs associated with downtime, SKF has developed a superior high-nitrogen steel.

The SKF assortment of super-precision angular contact ball bearings made from NitroMax steel have ceramic (bearing grade silicon nitride) rolling elements as standard.

Super-precision cylindrical roller bearings

SKF produces super-precision single row and double row cylindrical roller bearings. The characteristic features of these bearings are a low cross sectional height, high load carrying capacity, high rigidity and high-speed capability. They are therefore particularly well suited for machine tool spindles where the bearing arrangement must accommodate heavy radial loads and high speeds, while providing a high degree of stiffness.

Single row cylindrical roller bearings are produced in the N 10 series as basic design bearings and as high-speed design bearings. High-speed single row cylindrical roller bearings in the N 10 series are available with a tapered bore only and for shaft diameters ranging from 40 to 80 mm. Compared to previous high-speed design, they can accommodate a speed increase of up to 30% in grease lubricated applications and up to 15% in oil-air lubricated applications.

Double row cylindrical roller bearings are produced as standard in the NN design and NNU design.

Super-precision double direction angular contact thrust ball bearings

Double direction angular contact bearings, as their name implies, were developed by SKF to axially locate machine tool spindles in both directions.

The new optimized design of super-precision bearings in the BTW series consists of a set of two single row angular contact thrust ball bearings, arranged back-to-back. This configuration enables the bearings to accommodate axial loads in both directions while providing a high degree of system rigidity. These bearings can accommodate higher speeds compared to bearings in the former 2344(00) series. The bearings are available for shaft diameters ranging from 35 to 200 mm.

The redesigned high-speed BTM series accommodate higher speeds, anywhere from 6% to 12% depending on the size; minimize heat generation, even at higher speeds; provide high load carrying capacity and maintain a high degree of system rigidity. The range of BTM bearings series has been expanded to accommodate shaft diameters from 60 to 180 mm.

Super-precision angular contact thrust ball bearings for screw drives

Single direction angular contact thrust ball bearings in the BSA and BSD (BS) series are available for shaft diameters ranging from 12 to 75 mm. These bearings are characterized by superior axial stiffness and high axial load carrying capacity.

Double direction angular contact thrust ball bearings in the BEAS series have been developed for machine tool applications where space is tight and easy mounting is required. The bearings are available for shaft diameters ranging from 8 to 30 mm. Bearings in the BEAM series, which can accommodate shaft diameters ranging from 12 to 60 mm, can be bolt-mounted to an associated component.

Cartridge units are another solution for simple and quick mounting. Units in the FBSA (BSDU and BSQU) series incorporate SKF single direction angular contact thrust ball bearings and can accommodate shaft diameters ranging from 20 to 60 mm.

Super-precision axial-radial cylindrical roller bearings

SKF axial-radial cylindrical roller bearings are suitable for arrangements that have simultaneously acting (radial and axial) loads as well as moment loads.









Their internal design, together with close tolerance manufacturing processes, enable these bearings to attain better than P4 running accuracy.

Axial-radial cylindrical roller bearings are commonly used to support rotating tables, indexing tables and milling heads.



Table 1







Overview of SKF super-precision bearings

ISO dimension series	Bearing type and design <i>SKF publication^{1,2)}</i>		Variant	SKF assortment SKF bearings in the series	
18	Angular contact ball bearings: Basic design <i>Super-precision angular contact ball bearings: 718 (SEA) series (Publication No. 06810)</i>		Open	All-steel Hybrid	718 .. D (SEA) 718 .. D/H/C (SEA/NS)
			Open	All-steel Hybrid	719 .. B (HB) 719 .. B/H/C (HB/NS)
			Sealed	All-steel Hybrid	S719 .. B (HB/S) S719 .. B/H/C (HB/S/NS)
				Open	All-steel Hybrid
Sealed	All-steel Hybrid	S719 .. E (VEB/S) S719 .. E/H/C (VEB/S/NS)			
19	Angular contact ball bearings: High-speed, B design <i>Super-precision angular contact ball bearings: High-speed, B design, sealed as standard (Publication No. 06939)</i>		Open	All-steel Hybrid	719 .. D (SEB) 719 .. D/H/C (SEB/NS)
			Sealed	All-steel Hybrid	S719 .. D (SEB/S) S719 .. D/H/C (SEB/S/NS)
			Open	All-steel Hybrid	70 .. B (HX) 70 .. B/H/C (HX/NS)
			Sealed	All-steel Hybrid	S70 .. B (HX/S) S70 .. B/H/C (HX/S/NS)
10	Angular contact ball bearings: High-speed, E design <i>Super-precision angular contact ball bearings: High-speed, E design (Publication No. 10112)</i>		Open	All-steel Hybrid	70 .. E (VEX) 70 .. E/H/C (VEX/NS)
			Sealed	All-steel Hybrid	S70 .. E (VEX/S) S70 .. E/H/C (VEX/S/NS)
			Open	All-steel Hybrid	70 .. D (EX) 70 .. D/H/C (EX/NS)
Sealed	All-steel Hybrid		S70 .. D (EX/S) S70 .. D/H/C (EX/S/NS)		
02	Angular contact ball bearings: High-capacity, basic design <i>Super-precision angular contact ball bearings: High-capacity (Publication No. 06981)</i>		Open	All-steel Hybrid	72 .. D (E 200) 72 .. D/H/C (E 200/NS)
			Sealed	All-steel Hybrid	S72 .. D (E 200/S) S72 .. D/H/C (E 200/S/NS)
49	Double row cylindrical roller bearings: NNU design		Open	All-steel	NNU 49 BK

¹⁾ Where applicable, information can be found in the SKF publication *High-precision bearings* (Publication No. 6002).

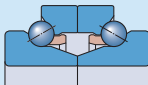
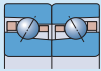
²⁾ For additional information about super-precision angular contact ball bearings made from NitroMax steel, refer to the SKF publication *Extend bearing service life with NitroMax* (Publication No. 10126).

Overview of SKF super-precision bearings

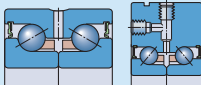
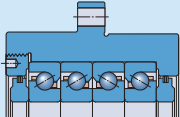
ISO dimension series	Bearing type and design <i>SKF publication^{1,2)}</i>		Variant		SKF assortment SKF bearings in the series
10	Single row cylindrical roller bearings: Basic design		Open	All-steel Hybrid	N 10 KTN N 10 KTN/HC5
	Single row cylindrical roller bearings: High-speed design <i>Super-precision cylindrical roller bearings: High-speed (Publication No. 07016)</i>		Open	All-steel Hybrid	N 10 KPHA N 10 KPHA/HC5
30	Double row cylindrical roller bearings: NN design		Open	All-steel Hybrid	NN 30 KTN NN 30 KTN/HC5
– (Non-standardized)	Angular contact thrust ball bearings: Double direction, basic design <i>Super-precision double direction angular contact thrust ball bearings (Publication No. 10097)</i>		Open	All-steel Hybrid	BTW BTW /HC
	Angular contact thrust ball bearings: Double direction, high-speed design <i>Higher-speed capability with the new BTM bearing series design (Publication No. 12119)</i>		Open	All-steel Hybrid	BTM BTM /HC
02	Angular contact thrust ball bearings: Single direction <i>Super-precision angular contact thrust ball bearings for screw drives (Publication No. 06570)</i>		Open Sealed	All-steel All-steel	BSA 2 (BS 200) BSA 2 .. (BS 200 ..)
03	Angular contact thrust ball bearings: Single direction <i>Super-precision angular contact thrust ball bearings for screw drives (Publication No. 06570)</i>		Open Sealed	All-steel All-steel	BSA 3 (BS 3) BSA 3 .. (BS 3 ..)
– (Non-standardized)	Angular contact thrust ball bearings: Single direction <i>Super-precision angular contact thrust ball bearings for screw drives (Publication No. 06570)</i>		Open Sealed	All-steel All-steel	BSD (BS ..) BSD .. (BS ..)
	Angular contact thrust ball bearings: Double direction		Sealed	All-steel	BEAS (BEAS) BEAM (BEAM)
	Cartridge unit with angular contact thrust ball bearings		Sealed	All-steel	FBSA (BSDU, BSQU) –

¹⁾ Where applicable, information can be found in the SKF publication *High-precision bearings* (Publication No. 6002).

²⁾ For additional information about super-precision angular contact ball bearings made from NitroMax steel, refer to the SKF publication *Extend bearing service life with NitroMax* (Publication No. 10126).

SKF – the knowledge engineering company

From the company that invented the self-aligning ball bearing more than 100 years ago, SKF has evolved into a knowledge engineering company that is able to draw on five technology platforms to create unique solutions for its customers. These platforms include bearings, bearing units and seals, of course, but extend to other areas including: lubricants and lubrication systems, critical for long bearing life in many applications; mechatronics that combine mechanical and electronics knowledge into systems for more effective linear motion and sensorized solutions; and a full range of services, from design and logistics support to condition monitoring and reliability systems.

Though the scope has broadened, SKF continues to maintain the world's leadership in the design, manufacture and marketing of rolling bearings, as well as complementary products such as radial seals. SKF also holds an increasingly important position in the market for linear motion products, high-precision aerospace bearings, machine tool spindles and plant maintenance services.

The SKF Group is globally certified to ISO 14001, the international standard for environmental management, as well as OHSAS 18001, the health and safety management standard. Individual divisions have been approved for quality certification in accordance with ISO 9001 and other customer specific requirements.

With over 120 manufacturing sites worldwide and sales companies in 70 countries, SKF is a truly international corporation. In addition, our distributors and dealers in some 15 000 locations around the world, an e-business marketplace and a global distribution system put SKF close to customers for the supply of both products and services. In essence, SKF solutions are available wherever and whenever customers need them. Overall, the SKF brand and the corporation are stronger than ever. As the knowledge engineering company, we stand ready to serve you with world-class product competencies, intellectual resources, and the vision to help you succeed.



© Airbus – photo: e*im company, H. Goussé

Evolving by-wire technology

SKF has a unique expertise in the fast-growing by-wire technology, from fly-by-wire, to drive-by-wire, to work-by-wire. SKF pioneered practical fly-by-wire technology and is a close working partner with all aerospace industry leaders. As an example, virtually all aircraft of the Airbus design use SKF by-wire systems for cockpit flight control.

SKF is also a leader in automotive by-wire technology, and has partnered with automotive engineers to develop two concept cars, which employ SKF mechatronics for steering and braking. Further by-wire development has led SKF to produce an all-electric forklift truck, which uses mechatronics rather than hydraulics for all controls.

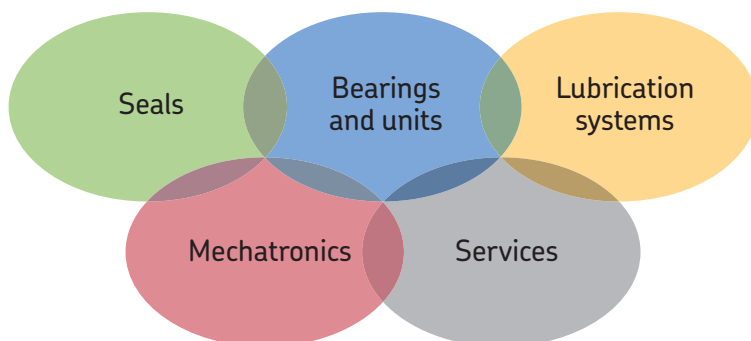



Harnessing wind power

The growing industry of wind-generated electric power provides a source of clean, green electricity. SKF is working closely with global industry leaders to develop efficient and trouble-free turbines, providing a wide range of large, highly specialized bearings and condition monitoring systems to extend equipment life of wind farms located in even the most remote and inhospitable environments.



Working in extreme environments

In frigid winters, especially in northern countries, extreme sub-zero temperatures can cause bearings in railway axleboxes to seize due to lubrication starvation. SKF created a new family of synthetic lubricants formulated to retain their lubrication viscosity even at these extreme temperatures. SKF knowledge enables manufacturers and end user customers to overcome the performance issues resulting from extreme temperatures, whether hot or cold. For example, SKF products are at work in diverse environments such as baking ovens and instant freezing in food processing plants.



Developing a cleaner cleaner

The electric motor and its bearings are the heart of many household appliances. SKF works closely with appliance manufacturers to improve their products' performance, cut costs, reduce weight, and reduce energy consumption. A recent example of this cooperation is a new generation of vacuum cleaners with substantially more suction. SKF knowledge in the area of small bearing technology is also applied to manufacturers of power tools and office equipment.



Maintaining a 350 km/h R&D lab

In addition to SKF's renowned research and development facilities in Europe and the United States, Formula One car racing provides a unique environment for SKF to push the limits of bearing technology. For over 60 years, SKF products, engineering and knowledge have helped make Scuderia Ferrari a formidable force in F1 racing. (The average racing Ferrari utilizes around 150 SKF components.) Lessons learned here are applied to the products we provide to automakers and the aftermarket worldwide.



Delivering Asset Efficiency Optimization

Through SKF Reliability Systems, SKF provides a comprehensive range of asset efficiency products and services, from condition monitoring hardware and software to maintenance strategies, engineering assistance and machine reliability programmes. To optimize efficiency and boost productivity, some industrial facilities opt for an Integrated Maintenance Solution, in which SKF delivers all services under one fixed-fee, performance-based contract.



Planning for sustainable growth

By their very nature, bearings make a positive contribution to the natural environment, enabling machinery to operate more efficiently, consume less power, and require less lubrication. By raising the performance bar for our own products, SKF is enabling a new generation of high-efficiency products and equipment. With an eye to the future and the world we will leave to our children, the SKF Group policy on environment, health and safety, as well as the manufacturing techniques, are planned and implemented to help protect and preserve the earth's limited natural resources. We remain committed to sustainable, environmentally responsible growth.



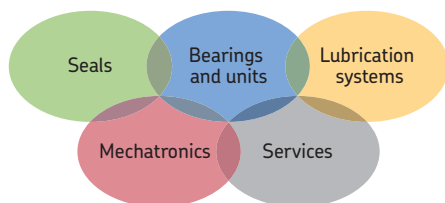

The Power of Knowledge Engineering

Drawing on five areas of competence and application-specific expertise amassed over more than 100 years, SKF brings innovative solutions to OEMs and production facilities in every major industry worldwide. These five competence areas include bearings and units, seals, lubrication systems, mechatronics (combining mechanics and electronics into intelligent systems), and a wide range of services, from 3-D computer modelling to advanced condition monitoring and reliability and asset management systems. A global presence provides SKF customers uniform quality standards and worldwide product availability.

© SKF and SNFA are registered trademarks of the SKF Group.

© SKF Group 2012

The contents of this publication are the copyright of the publisher and may not be reproduced (even extracts) unless prior written permission is granted. Every care has been taken to ensure the accuracy of the information contained in this publication but no liability can be accepted for any loss or damage whether direct, indirect or consequential arising out of the use of the information contained herein.

PUB BU/P2 06981/5 EN · May 2012

This publication supersedes all information about SKF bearings in the 72 .. D series in the SKF publication *High-precision bearings* (Publication No. 6002), and SNFA bearings in the E 200 series in the *SNFA General Catalogue*.

