

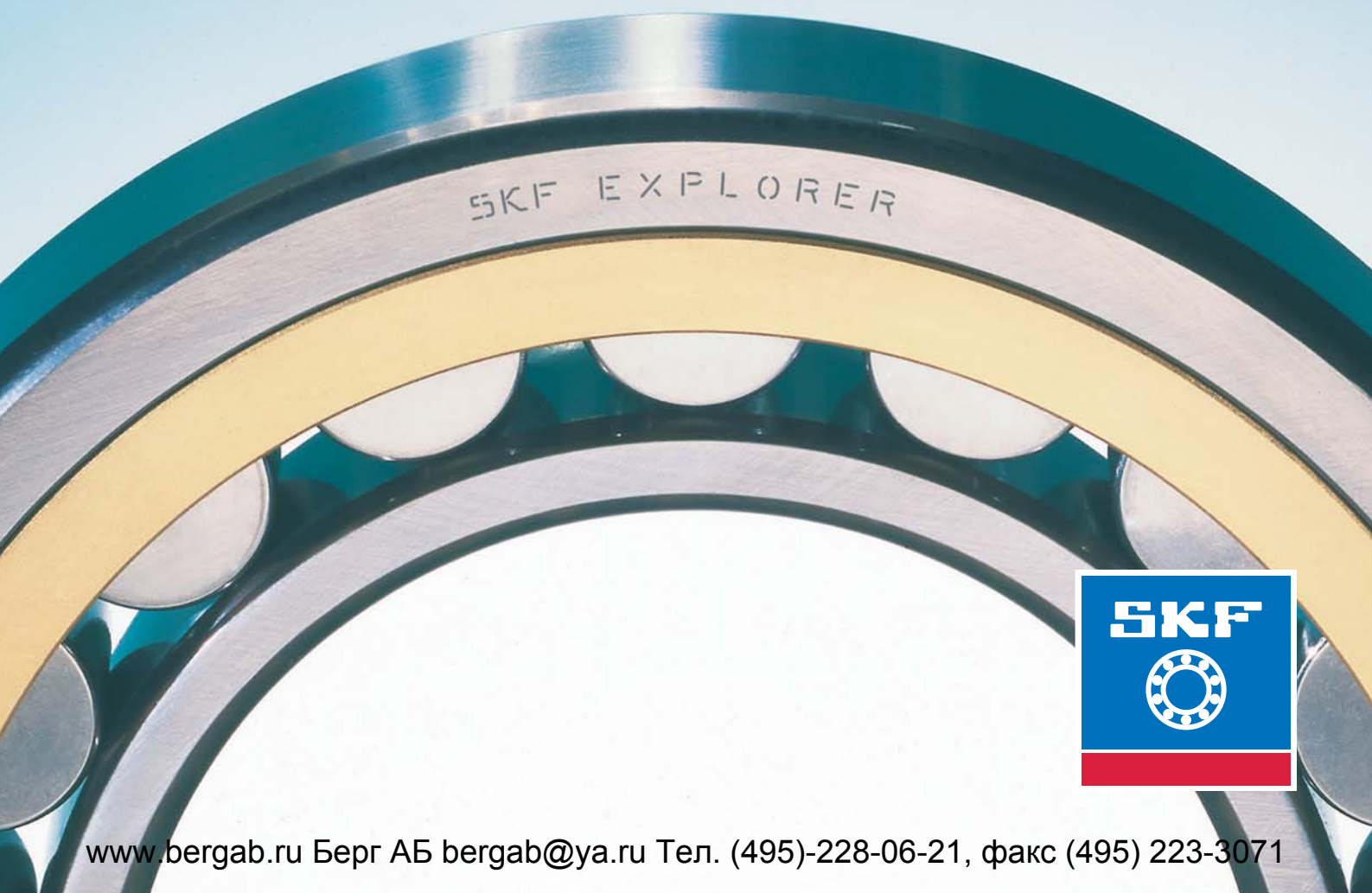

SKF cylindrical roller bearings - always in the lead



Contents

The SKF brand now stands for more than ever before, and means more to you as a valued customer.

While SKF maintains its leadership as the hallmark of quality bearings throughout the world, new dimensions in technical advances, product support and services have evolved SKF into a truly solutions-oriented supplier, creating greater value for customers.

These solutions encompass ways to bring greater productivity to customers, not only with breakthrough application-specific products, but also through leading-edge design simulation tools and consultancy services, plant asset efficiency maintenance programmes, and the industry's most advanced supply management techniques.

The SKF brand still stands for the very best in rolling bearings, but it now stands for much more.

SKF – The knowledge engineering company



1 Product information 3

Accommodate heavy loads, high speeds and axial displacements.....	3
SKF single row cylindrical roller bearings – better by design	4
SKF standard bearings – benefits	5
Optimized cross section	5
Optimal contact conditions	5
Interchangeability of bearing components	5
Cages made of three different materials	6
A wide product range	7
SKF Explorer cylindrical roller bearings – a new level of performance	10
Availability	13
Product designation	13
High performance in all applications	14

2 Recommendations 16

Selection of bearing size.....	16
Bearing life	16
Previous and new – a comparison	17
Design of bearing arrangements	18
Mounting and dismounting.....	20
Mounting	20
Dismounting	21
Lubrication and handling	22
Lubrication	22
Bearing handling	22
Comprehensive support for long-term success.....	23

3 Product data 24

Bearing data – general	24
Product table.....	32

Other SKF cylindrical roller bearings.....	62
---	-----------

SKF – The knowledge engineering company	64
--	-----------

Accommodate heavy loads, high speeds and axial displacements

Cylindrical roller bearings are produced in many designs, ISO Dimension Series and sizes. The vast majority are single row cylindrical roller bearings with a cage. These bearings are an excellent choice for applications where there are particularly heavy radial loads combined with high speeds, especially if there is a limited amount of axial displacement of the shaft with respect to the housing as a result of thermal elongation. As axial displacement takes place within the bearing, there is practically no increase in friction as the bearing rotates.

Single row cylindrical roller bearings are separable, i.e. the ring with roller and cage assembly can be mounted independently of the other ring. This

simplifies installation, particularly if an interference fit is required for both rings.

Single row cylindrical roller bearings with a cage are produced in many designs, differing primarily in the configuration of the flanges. The rollers are always guided between integral flanges on one of the rings. The ring with the integral flanges together with the cylindrical roller and cage assembly can be withdrawn from the other ring. The most popular single row cylindrical roller bearings are those of the NU, N, NJ and NUP designs.

NU design: The outer ring has two integral flanges while the inner ring has no flanges

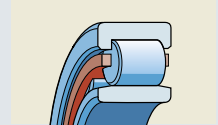

N design: The inner ring has two integral flanges while the outer ring has no flanges

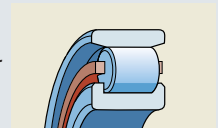

NJ design: The outer ring has two integral flanges while the inner ring has one integral flange

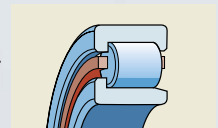

NUP design: The outer ring has two integral flanges while the inner ring has one integral flange and one loose flange ring

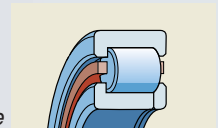

High radial load carrying capacity

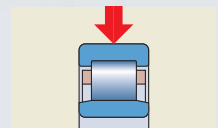

High speed capability

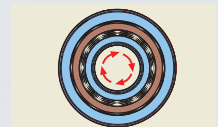

Accommodate axial displacement

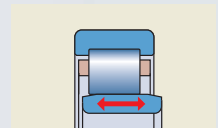

Separable design

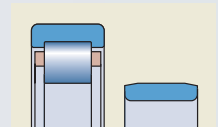

SKF cylindrical roller bearings – better by design

SKF milestones leading to the single row cylindrical roller bearings of today

- 1909: Patent granted to Dr.-Ing. Kirner for the “NU bearing”
- 1930: Participation in standardization of boundary dimensions
- 1950: Introduction of the “B” roller, slightly crowned toward the roller ends, in order to prevent damaging edge stresses
- 1962: Introduction of the E-type cylindrical roller bearings with reinforced roller complement
- 1981: Introduction of the EC cylindrical roller bearings with modified roller end/flange contact
- 1984: Introduction of the logarithmic contact profile providing excellent load distribution
- 2002: Introduction of SKF Explorer performance class bearings

Norma-Compagnie, Cannstatt, Germany. This company was incorporated into the SKF Group in 1914. Since then, the history of the single row cylindrical roller bearing has been intertwined with that of SKF and there have been many developmental milestones.

With each milestone, SKF offered design and maintenance engineers the option to power up, size-down and improve the performance of their application.

In the 1960s, SKF's development of the E-bearing, with its reinforced roller complement, increased the load carrying ability by an average of 35 %. Then, in the 1980's when SKF introduced the single row EC cylindrical roller bearing, design engineers and end-users were

offered three additional advantages: increased axial load carrying ability, optimized running properties and reduced maintenance. These are just two of the SKF pioneering successes from the past.

In addition to the caged single row cylindrical roller bearings described and listed in this brochure, the comprehensive SKF cylindrical roller bearing assortment also includes single and double row full complement bearings (without cage), precision bearings, multi-row bearings, printing press bearings as well as support rollers (→ pages 62 and 63).

Cylindrical roller bearings are a tradition within SKF. It is hardly surprising that the major technical developments for these bearings have been initiated by SKF.

It all started in 1909 with the invention of the modern caged single row cylindrical roller bearing by Dr.-Ing. Josef Kirner, a leading engineer at the

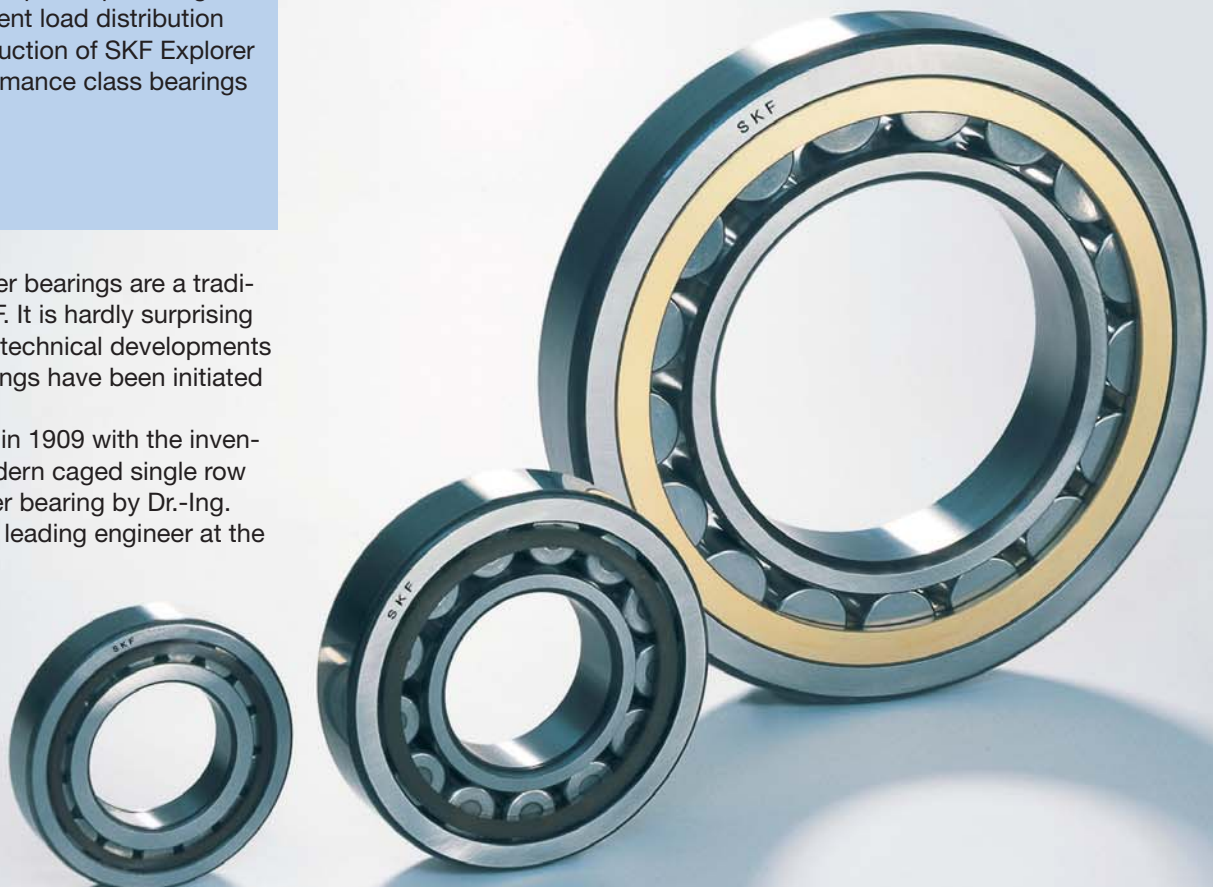
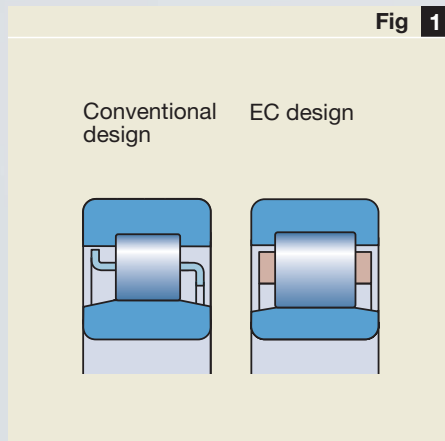

Fig 1



Optimized cross section

SKF standard bearings – benefits

When an application calls for bearings that can accommodate heavy radial loads, high speeds and axial displacement of the shaft with respect to the housing, SKF single row cylindrical roller bearings are an obvious choice. These bearings are always state-of-the-art and they feature

- an optimized cross section,
- excellent contact conditions,
- interchangeability of bearing components
- cages made of three different materials and
- a wide product range.

The second improvement deals specifically with the roller end/flange contact. The geometry of the flange has an “opened” design (→ fig 3) and the roller ends are surface treated to improve the effectiveness of the lubricant, reduce friction and lower operating temperatures. The improved roller end/flange contact results also in higher axial load capability for those bearings with flanges on inner and outer rings.

The optimal internal geometry provides

- higher radial and axial load carrying capacity,
- higher operational reliability,
- longer service life,
- extended maintenance intervals,
- lighter, more compact, energy-saving designs.

Fig 2

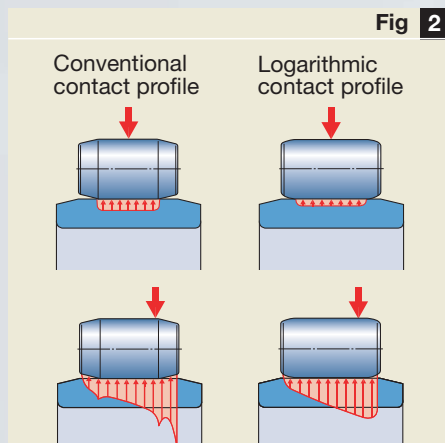

Optimal contact conditions

The result is an assortment of cylindrical roller bearings that will provide long service life even under the most arduous operating conditions.

Optimized cross section

The cross section of SKF cylindrical roller bearings is optimally utilized. The diameter and length of the rollers and the wall thickness of the rings and retaining flanges have been optimized to provide maximum bearing service life (→ fig 1). The optimized cross section of SKF cylindrical roller bearings enables manufacturers to downsize their designs so that they are more cost-effective, lighter and consume less energy, without affecting performance.

Interchangeability of bearing components

Another advantage of SKF single row cylindrical roller bearings is that the bearing components are completely interchangeable. Any bearing ring with cage and roller assembly can be assembled with any removable ring of the same bearing type and size. This is particularly important with bearing components that have to be mounted independently of each other.

Fig 3

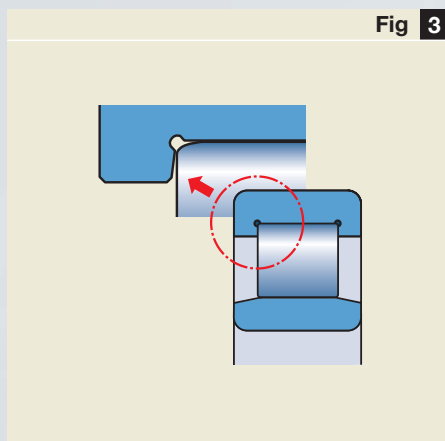

Opened flanges

Optimal contact conditions

The internal geometry of SKF single row cylindrical roller bearings is special in two very significant ways.

First is the “logarithmic contact profile” between the rollers and raceways (→ fig 2). This profile provides optimal load distribution between the roller and raceway, to significantly reduce the risk of edge stresses and increase operational reliability even in applications where there is misalignment and shaft deflections.

Cages made of three different materials

SKF single row cylindrical roller bearings are used in a wide range of applications and subjected to very different operating conditions. As a result, no single cage could satisfy all possible demands. To meet the needs of design engineers, cages are made from three different materials:

- polyamide,
- steel and
- brass.

Bearings fitted with a polyamide cage are suitable for the majority of applications. Metal cages are usually used for difficult operating conditions.

Polyamide cages

This injection moulded, window-type cage of glass fibre reinforced and heat stabilized polyamide 6,6 is the standard recommendation for SKF small and medium size single row cylindrical roller bearings. Its advantageous properties speak for themselves:

- high elasticity,
- light weight,
- quiet running from good damping,
- excellent tribological properties, and
- very good behaviour under emergency running.

These properties have been confirmed by the successful operation of millions of bearings. Bearings with this polyamide cage carry the designation suffix P, e.g. NU 203 ECP.

Steel window-type cages

A pressed steel window-type cage is available for a large number of bearings, mainly as an alternative to the standard P cage. Bearings fitted with a pressed steel cage are an excellent choice for applications where high temperatures or aggressive lubricants make the use of a polyamide cage unsuitable. Such bearings are identified by the designation suffix J, e.g. NU 310 ECJ, or no suffix.

Machined brass cages

There are several machined brass cage designs available for SKF single row cylindrical roller bearings: roller guided cages and shoulder guided cages. Roller guided cages are centred on the roller complement and are typically used for grease lubricated bearing arrangements. Shoulder guided cages are centred on one of the bearing rings and are typically used in oil lubricated applications.

One-piece machined brass cages

The one-piece form-turned window-type brass cage is an SKF innovation and represents the new generation of machined brass cages for SKF single row cylindrical roller bearings.

The advantages of this machined brass cage include:

- very high strength,
- suitable for very high speeds and accelerations,
- suitable for high temperatures,
- high endurance limit,
- light weight design, and
- excellent lubrication conditions in the roller/cage contact zones.

Bearings fitted with an inner or outer ring centred, form-turned window-type brass cage are identified by the designation suffix ML, e.g. NU 2314 ECML.

Two-piece machined brass pronged cages

This cage is designed as a pronged cage with a cover. It features strong cage bars with machined trapezoidal shaped prongs that are peened in place. As a result, heat-induced expansion has no influence on cage strength.

Depending on bearing size this brass cage is either

- roller guided, designation suffix M, e.g. NU 232 ECM, or
- outer ring guided, designation suffix MA, e.g. NU 232 ECMA,

and in some cases there is a choice of guidance for the same bearing size.



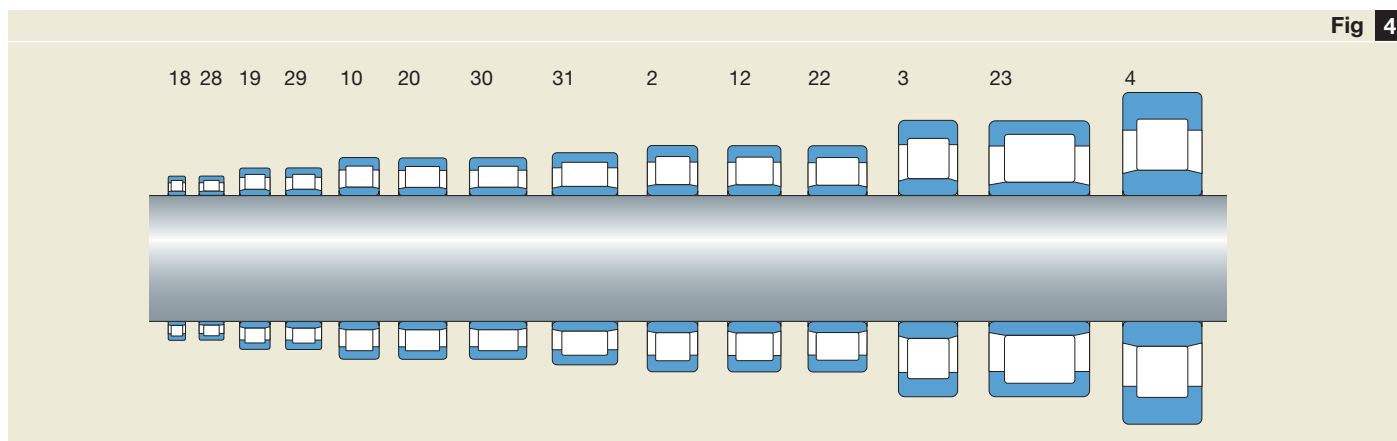

Fig 4

Bearing series

A wide product range

The SKF manufacturing programme of single row cylindrical roller bearings with a cage includes the Dimension Series shown in **fig 4**. The standard range comprises all flange configurations and sizes normally used, starting at 15 mm bore diameter up to 800 mm bore diameter. The SKF standard range of bearings covers the

- Dimension Series 2, 3, 4, 10, 12, 20, 22 and 23 and
- NU, N, NJ and NUP designs.

The SKF programme includes

- standard design bearings,
- standard design bearings without the removable ring,
- special design bearings,

as well as a large number of matching angle rings.

Standard design bearings

Standard design SKF single row cylindrical roller bearings are manufactured in four different designs. The main difference between them is the flange configuration. These four designs (**→ fig 5**) are described below and listed in the product table starting on **page 32**.

NU design

The outer ring of an NU-design bearing has two integral flanges while the inner ring has no flanges (**a**). Axial displacement of the shaft with respect to the housing can be accommodated in both directions.

N design

The inner ring of an N-design bearing has two integral flanges while the outer ring has no flanges (**b**). Axial displacement of the shaft with respect to the housing can be accommodated in both directions.

NJ design

The outer ring of an NJ-design bearing has two integral flanges and the inner ring has one integral flange (**c**). These bearings can locate the shaft axially in one direction only.

NUP design

The outer ring of an NUP-design bearing has two integral flanges and the inner ring has one integral flange and one non-integral flange in the form of a loose flange ring (**d**). These bearings can be used as locating bearings to locate the shaft axially in both directions.

Standard bearing designs

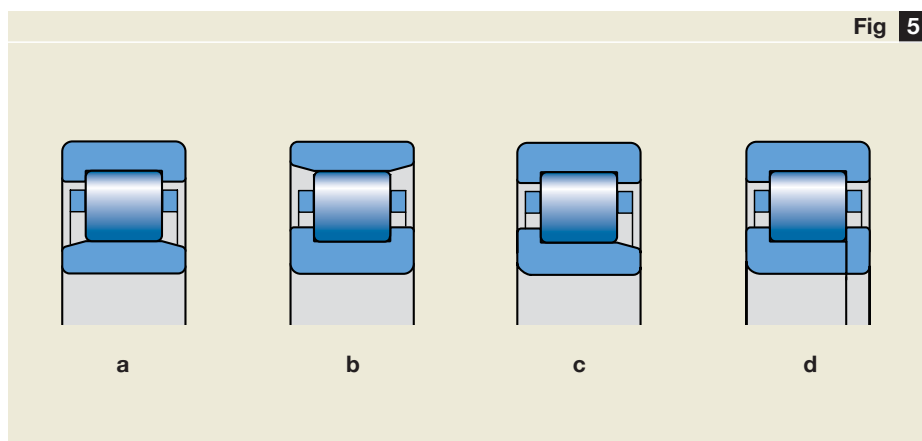
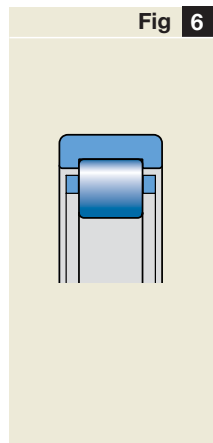
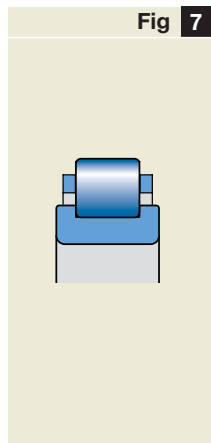

Fig 5



RNU design



RN design

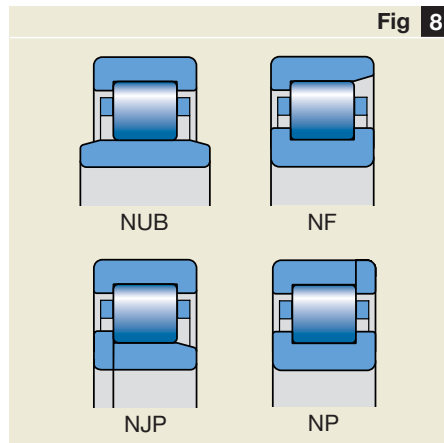

Special designs

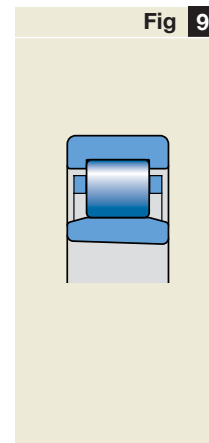

Bearing with a tapered bore

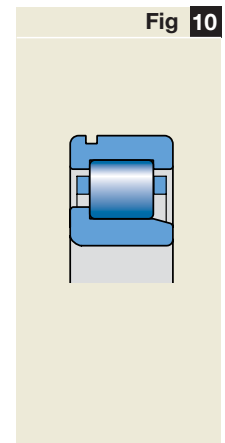

Bearing with a snap ring groove in the outer ring

Standard design bearings without the removable ring

SKF supplies a selection of NU-design cylindrical roller bearings without an inner ring (→ fig 6) – designation prefix RNU – and N-design bearings without an outer ring (→ fig 7) – designation prefix RN. These bearings provide a solution for applications where hardened and ground raceways are provided on the shaft or in the housing bore.

Because RNU bearings, for example, do not need an inner ring, the shaft diameter can be larger to provide a stronger, stiffer arrangement. Additionally, the possible axial displacement of the shaft relative to the housing is only limited by the width of the raceway on the shaft.

Special design bearings

Other single row cylindrical roller bearings included in the SKF standard programme, but not shown in this brochure, are special design bearings

- with an extended inner ring (→ fig 8),
- with flange configurations (→ fig 8) that differ from the standard designs,
- with a tapered bore,
- with a snap ring groove in the outer ring,
- with location slots in the outer ring.

Please contact SKF for availability of these special design bearings before ordering. Details of these bearings can be found in the SKF Interactive

Engineering Catalogue, available on CD-ROM or online at www.skf.com.

Bearings with a tapered bore

SKF single row cylindrical roller bearings are produced as standard with a cylindrical bore. However, some bearings with a tapered bore 1:12 can be supplied (→ fig 9). Bearings with a tapered bore have a somewhat larger radial internal clearance than corresponding bearings with a cylindrical bore and are identified by the designation suffix K.

Bearings with a snap ring groove

Some single row cylindrical roller bearings are also produced with a snap ring groove in the outer ring (→ fig 10). These bearings are identified by the designation suffix N. Because they can be located axially in the housing bore by a retaining or snap ring, the design of the arrangement can be simplified and made more compact.

The dimensions of the snap ring groove and of the chamfer adjacent to the groove are in accordance with ISO 464:1995, which also specifies suitable snap ring dimensions.

Bearings with locating slots

In some applications where it is essential that mounting and dismounting can be done easily, outer rings have to be mounted with a clearance fit in the

housing. To restrain the outer ring from turning in the circumferential direction, SKF single row cylindrical roller bearings are also available with

- one locating slot, designation suffix N1, or
- two locating slots positioned 180° apart, designation suffix N2,

in one outer ring side face (→ fig 11). The dimensions of the locating slots are in accordance with DIN 5412-1:2000.

Additional SKF cylindrical roller bearings

Information on additional SKF cylindrical roller bearings belonging to the SKF product range can be found on pages 62 and 63.

Bearing with a locating slot

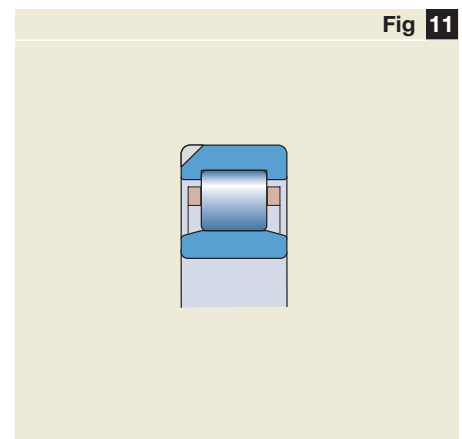

Angle rings

Angle rings, series designation HJ, are designed to stabilize NU- and NJ-type cylindrical roller bearings in the axial direction (→ **fig 12**). They are used in heavily loaded applications instead of an NUP-type bearing because the full width inner ring of the NU- or NJ-type bearing provides a more stable seating than the shorter inner ring and loose flange of an NUP-type bearing. Also, angle rings very often simplify mounting and dismounting.

SKF angle rings, manufactured from carbon chromium steel are hardened and ground. The side face runout conforms to the SKF Normal tolerance class of the appropriate bearing. HJ angle rings, where available, are listed in the product table with their designation and dimensions together with the relevant bearing.

NU + HJ execution

NU-design bearings combined with an HJ angle ring (**a**) can be used to locate the shaft axially in one direction.

NJ + HJ execution

NJ-design bearings combined with an HJ angle ring (**b**) can be used as locating bearings to provide axial shaft location in both directions.

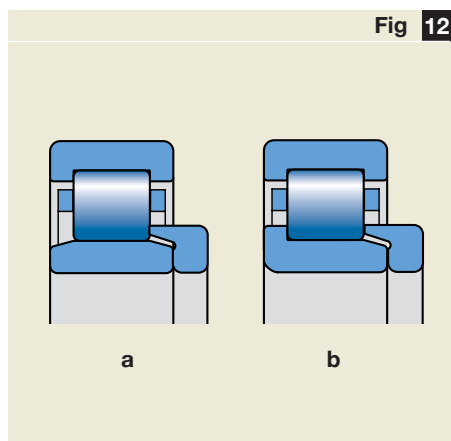

Bearings with an angle ring

SKF Explorer cylindrical roller bearings – a new level of performance

Single row cylindrical roller bearings are also available in the new SKF Explorer performance class for endurance and reliability. They are the result of many years of intensive research by an international team of SKF scientists and engineers. During this time SKF materials and manufacturing specialists together with those responsible for production have successfully completed the puzzle of how to combine the pieces

- material
- heat treatment
- material hardness
- manufacturing quality
- logarithmic contact profile
- roller end/flange geometry
- surface finish
- cage design

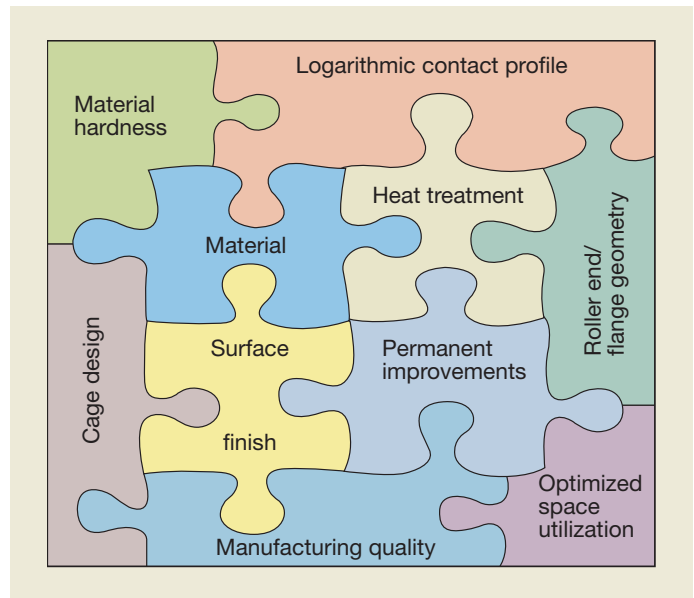

to form an optimum product. The result is one to be proud of: single row cylindrical roller bearings that set new standards with respect to performance and endurance; single row cylindrical roller bearings with enhanced ability to support dynamic loads; single row

Performance improvements permit downsizing

Diagram 1

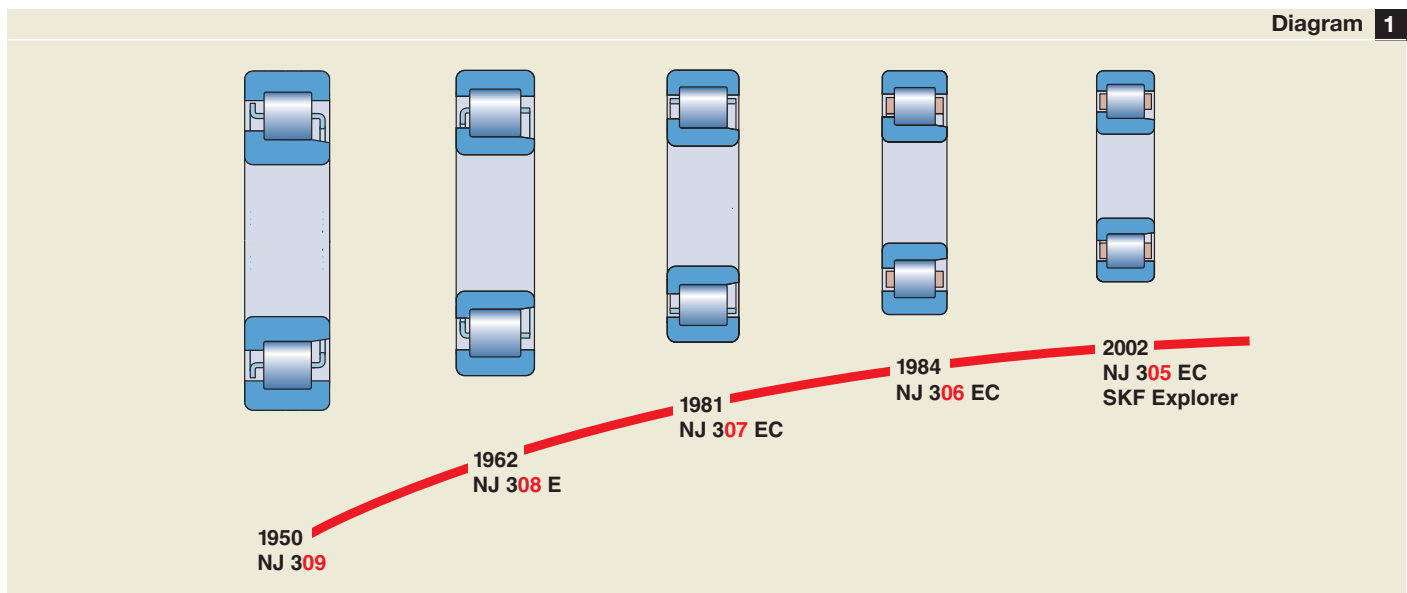

cylindrical roller bearings with up to three times longer service life than the previous SKF standard, which is superior to all other conventional cylindrical roller bearings. The performance improvements of SKF cylindrical roller bearings over the past 50 years have permitted downsizing, whilst still maintaining the required performance (→ **diagram 1**).

Material

SKF Explorer bearings feature an extremely clean and homogenous steel with a minimum number of inclusions. This improved steel is so much cleaner than the highest grades covered by present classifications. The reduction in the number of inclusions increases the fatigue strength in the rolling contacts and enables the bearings to operate much longer.



Logarithmic contact profile

This important feature of SKF cylindrical roller bearings – for the past twenty-odd years – has been further refined for the rollers used in SKF Explorer bearings. The bearings are thus even less sensitive to small misalignment and can carry heavy loads.



1

Heat treatment

New heat treatment procedures optimize the bearing resistance to operational damage and temperatures without affecting dimensional stability.



Roller end/flange geometry

The optimized roller end/flange contacts of SKF cylindrical roller bearings are also present in SKF Explorer bearings. The resultant advantages include reduced friction, lower operating temperatures and less wear.



Material hardness

The hardness of the rings and rollers of SKF Explorer bearings have been selected for optimum performance. This makes them less sensitive to contaminants and contributes to their extremely long service life.



Surface finish

The surface finish of the raceways on the rings and rollers has been further refined and provides enhanced lubrication conditions in SKF Explorer bearings so that they can operate longer even under poor lubrication conditions.



Manufacturing quality

Upgraded manufacturing processes have contributed to a significant improvement in product quality. This means that the rings can be produced with an increased roundness and the deviation from true form of the rollers has also been further reduced. The results of the tighter tolerances may be invisible but the bearings run markedly quieter and with less vibration.



Cage design

The design and material of the cage can have a significant impact on a bearing's ability to withstand given operating conditions. That is the reason for making SKF Explorer bearings available with up to four different cages. The design of the cages used in SKF Explorer bearings contributes to good lubrication of all contact surfaces, even under occasional interruptions in lubricant supply.



The proof is in the performance ...

If an SKF Explorer cylindrical roller bearing is compared with any other cylindrical roller bearing, several unique design features will be discovered. These derive from the many improvements described before and make the SKF Explorer performance class bearings superior. The numerous "micro" improvements do not become obvious until the bearing goes into operation. It runs more quietly as well as longer – in fact much, much longer than any cylindrical roller bearing used so far – because it is an SKF Explorer bearing.

.... as well as the long life

To take full advantage of the increased load carrying capacity and improved wear resistance, the life of SKF Explorer bearings should always be calculated using the SKF rating life. In this calculation, the life extending improvements to SKF Explorer bearings are taken into account by

- an increased basic dynamic load rating, and
- an increased SKF life modification factor a_{SKF} , adjusted by multiplying the term $\eta_c (P_u/P)$ by 1,4 to take into account the improved material and operating behaviour.

All the product improvements described can be exploited, for example,

- to increase service life of existing designs,
- to maintain power output of new designs,
- to increase power output of existing designs or
- to increase power density of new designs.

Increase service life of existing designs

Don't need to increase power output?
Use an SKF Explorer bearing of equal size to:

- Increase safety factor
- Reduce vibration
- Reduce heat generation
- Increase service intervals
- Increase machine uptime

Maintain power output of new designs

Use a smaller SKF Explorer bearing to:

- Reduce overall dimensions to save on material costs and weight
- Achieve a stiffer design
- Reduce heat generation
- Increase speeds

Increase power output of existing designs

Avoid costly redesign by using an SKF Explorer bearing of equal size to:

- Increase power density
- Increase speeds
- Increase loads

Increase power density of new designs

Use a lower section height SKF Explorer bearing with the same outside diameter to:

- Increase shaft size
- Achieve a stiffer design
- Operate at the same or higher speeds

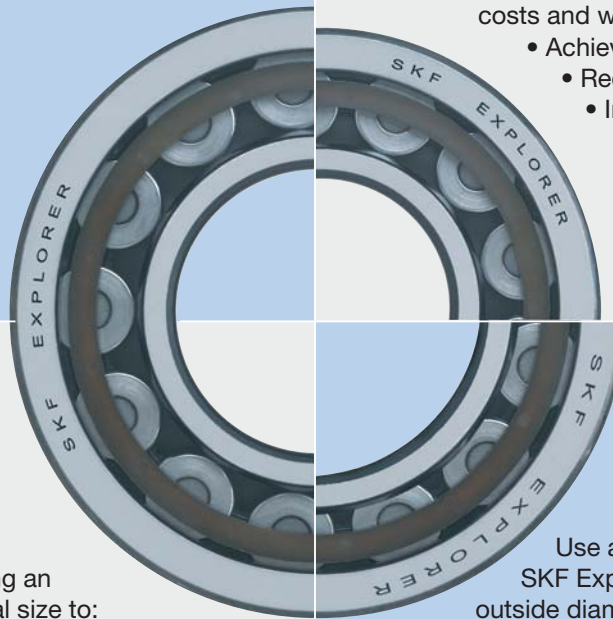

Availability

The most common cylindrical roller bearings of the N, NU, NJ and NUP designs in the 2, 3, 22 and 23 Dimension Series are available as SKF Explorer bearings. They are listed in the product table, printed in blue.

Product designation

SKF Explorer bearings retain the designation of earlier standard bearings, e.g. NJ 2218 ECP or NU 2330 ECMA. However, each bearing and its box are marked with the name EXPLORER, to avoid confusion.



High performance in all applications

SKF cylindrical roller bearings – especially SKF Explorer bearings – are state-of-the-art products. Their characteristics make them suitable for use in all types of industrial applications and essential for some.

Here are just a few examples from the extensive range of SKF cylindrical roller bearing applications.

Commercial vehicle rear axle gear

SKF cylindrical roller bearings contribute significantly to enhanced operational reliability and extended vehicle service life.

Two-stage bevel gear

High radial load carrying capacity, wide speed range, low friction and easy axial displacement in a non-locating bearing are just some of the characteristics which make SKF cylindrical roller bearings so interesting to gearbox manufacturers.

Applications

- Stationary gearboxes
- Automotive gearboxes
- Electric motors
- Vibration motors
- Vibration generators for road rollers
- Pumps and compressors
- Ventilators
- Material handling equipment
- Paper machines
- Textile machinery
- Rail vehicles
- Rolling mills
- Wind turbines

Requirements

- Most modern design
- High load carrying capacity
- Compact bearings
- High speed capability
- High operational reliability
- High running accuracy
- Quiet operation, low vibration
- Low operating temperatures
- Easy mounting
- Little maintenance
- Extremely long service life
- Large choice of variants
- Worldwide availability

Solution



Marine reduction gear

SKF cylindrical roller bearings have made a significant contribution to ship safety and manoeuvrability over many, many sea miles.

Screw compressor with oil-lubricated screw flanks

Bearings must be able to support heavy dynamic loads and operate at high speeds – good reasons for selecting SKF cylindrical roller bearings with an injection moulded PEEK cage, for example, to support the screws at the non-locating end.

Vibration motors

Depending on their size, SKF cylindrical roller bearings of the NJ design with a polyamide 6,6 cage or a one-piece window-type brass cage can accommodate heavy loads and high speeds in combination with considerable eccentric motion.

These few examples do not do justice to the full range of applications for cylindrical roller bearings and in particular to those of SKF Explorer cylindrical roller bearings in industry.



Selection of bearing size

Bearing life

For modern high quality bearings the basic rating life can deviate significantly from the actual service life in a given application. Therefore ISO 281:1990/Amd 2:2000 contains a modified life equation to supplement the basic rating life, which now makes predicting the bearing life of SKF Explorer bearings more precise.

This life calculation makes use of a modification factor to account for the amount of contamination, the viscosity of the lubricant, and the fatigue limit of the material. The SKF life modification factor a_{SKF} applies to the standardized concept.

The SKF rating life of a roller bearing according to ISO 281:1990/Amd 2:2000 is

$$L_{nm} = a_1 a_{SKF} \left(\frac{C}{P}\right)^{10/3}$$

If the speed is constant, the life can be expressed in operating hours, using the equation

$$L_{nmh} = a_1 a_{SKF} \frac{1\,000\,000}{60 n} \left(\frac{C}{P}\right)^{10/3}$$

where

L_{nm} = SKF rating life (at 100 – n % reliability), millions of revolutions

L_{nmh} = SKF rating life (at 100 – n % reliability), operating hours

a_1 = life adjustment factor for reliability according to ISO 281:1990, normally $a_1 = 1$

a_{SKF} = SKF life modification factor (→ **diagram 1**)

C = basic dynamic load rating, kN

P = equivalent dynamic bearing load, kN

n = rotational speed, r/min

Life modification factor a_{SKF}

This factor represents the relationship between the fatigue load limit ratio (P_U/P), the lubrication condition (viscosity ratio κ) and the contamination level in the bearing (η_c). Values for the factor a_{SKF} can be obtained from **diagram 1** as a function of η_c (P_U/P) for SKF standard and SKF Explorer cylindrical roller bearings and for different values of the viscosity ratio κ . Guideline values when selecting η_c are given in **table 1**. More detailed information can be found in the SKF General Catalogue or the SKF Interactive Engineering Catalogue, available on CD-ROM or online at www.skf.com.

Diagram 1 has been drawn up for a safety factor commonly used in fatigue life considerations and is valid for lubricants without EP additives. If a lubricant containing such additives is used, reference should be made to the SKF General Catalogue or the SKF Interactive Engineering Catalogue, available on CD-ROM or online at www.skf.com.

Equivalent dynamic bearing load

When dynamically stressed cylindrical roller bearings are used as non-locating bearings

$$P = F_r$$

If cylindrical roller bearings with flanges on both the inner and outer rings are used to locate a shaft in one or both directions, the equivalent dynamic bearing load can be calculated using

$$P = F_r \quad \text{when } F_a/F_r \leq e$$

$$P = 0,92 F_r + YF_a \quad \text{when } F_a/F_r > e$$

Table 1		
Degree of cleanliness/ contamination	Factor η_c for bearings with mean diameter d_m (mm)	
	≤ 100	> 100
Cleanliness		
Extreme	1	1
High	0,8 .. 0,6	0,9 .. 0,8
Normal	0,6 .. 0,5	0,8 .. 0,6
Contamination		
Slight	0,5 .. 0,3	0,6 .. 0,4
Typical	0,3 .. 0,1	0,4 .. 0,2
Severe	0,1 .. 0	0,1 .. 0

**Guideline values for factor η_c
for contamination level**

where

e = limiting value

= 0,2 for bearings

in the 10, 2, 3 and 4 series

= 0,3 for bearings

in the 22 and 23 series

Y = axial load factor

= 0,6 for bearings

in the 10, 2, 3 and 4 series

= 0,4 for bearings

in the 22 and 23 series

Since axially loaded cylindrical roller bearings only operate satisfactorily when they are subjected to a simultaneously acting radial load, the ratio F_a/F_r should not exceed 0,5.

Equivalent static bearing load

For statically stressed cylindrical roller bearings

$$P_0 = F_r$$

Previous and new – a comparison

The performance enhancements of SKF Explorer cylindrical roller bearings can best be demonstrated by life calculations for the bearing NU 207 ECP. For the same operating conditions the life of

- the previous standard NU 207 ECP with
 - a basic dynamic load rating $C = 48,4$ kN, and
 - a fatigue load limit $P_u = 6,1$ kN and
- the SKF Explorer bearing NU 207 ECP with
 - a basic dynamic load rating $C = 56$ kN, and
 - a fatigue load limit $P_u = 6,1$ kN

are calculated. The operating conditions are assumed to be

- an equivalent dynamic bearing load $P = 4,8$ kN,
- a viscosity ratio $\kappa = 2$, and
- a contamination level $\eta_c = 0,4$.

The L_{10m} lives of the two bearings are then as follows, since $a_1 = 1$.

Previous standard bearing

For $\eta_c (P_u/P) = 0,4 (6,1/4,8) = 0,5$ using the black values on the x axis in **diagram 1** and $\kappa = 2$

$$a_{SKF} \approx 3,2$$

so that the life becomes

$$L_{10m} = a_{SKF} (C/P)^{10/3} = 3,2 (48,4/4,8)^{10/3} = 7\ 080 \text{ millions of revolutions}$$

SKF Explorer bearing

For $\eta_c (P_u/P) = 0,4 (6,1/4,8) = 0,5$ using the blue values on the x axis in **diagram 1** and $\kappa = 2$

$$a_{SKF} \approx 6,2$$

so that the life becomes

$$L_{10m} = a_{SKF} (C/P)^{10/3} = 6,2 (56/4,8)^{10/3} = 22\ 320 \text{ millions of revolutions}$$

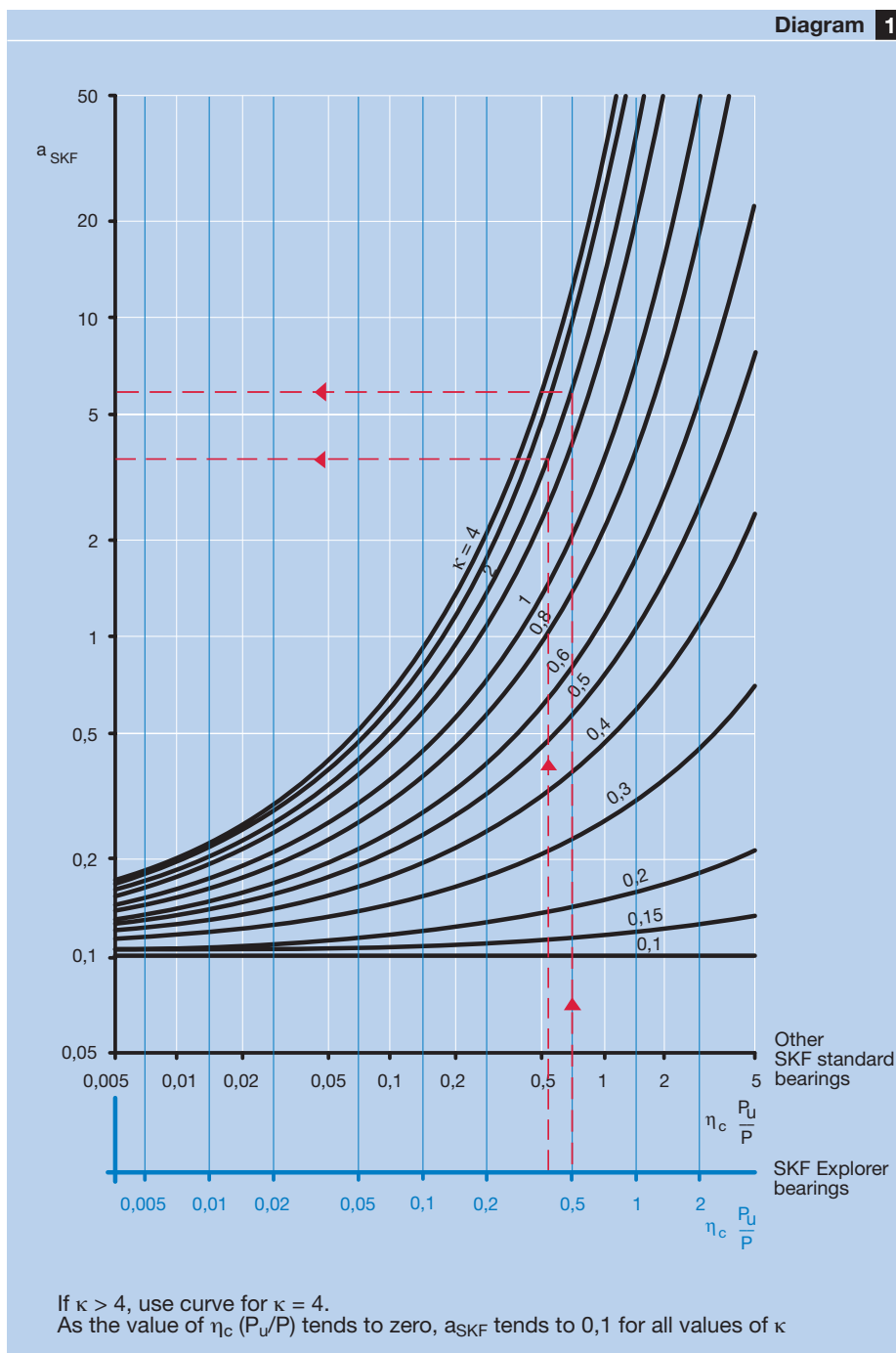

SKF life modification factor a_{SKF} for cylindrical roller bearings

In this comparison, the life of the SKF Explorer bearing, when compared to a previous standard bearing, is 22 320 hours versus 7 080 hours – or approximately three times longer life.

Design of bearing arrangements

When designing a bearing arrangement it is not just a question of selecting a suitable bearing and determining its size – a number of other factors have to be taken into account: type and quantity of lubricant, bearing fits and bearing clearance, design of associated components, selection of seals etc. Each individual decision influences the subsequent performance, reliability and economy of the bearing arrangement.

To design a bearing arrangement thus calls for some considerable experience as well as knowledge of mechanics. If this is available, the information contained in the SKF General Catalogue or the SKF Interactive Engineering Catalogue, available on CD-ROM or online at www.skf.com, should be adequate. If not, please contact the SKF application engineering service for assistance.

Here, the characteristics of SKF cylindrical roller bearings and their suitability for various application demands are presented.

Bearing arrangement

Because of their design characteristics, SKF cylindrical roller bearings are particularly suitable for bearing arrangements

- that have to accommodate heavy radial loads and sometimes also axial loads while operating at high speeds, and
- where there is a need to have interference fits on the shaft as well as in the housing.

Bearings with a flangeless inner or outer ring can accommodate axial displacements of the shaft as a result of thermal expansion. As axial displacement takes place within the bearing rather than between the bearing and shaft or housing bore, there is practically no increase in friction as the bearing rotates. Eliminating the axial interaction between the locating and the non-locating bearing means that stresses are low, temperature is minimized and maximum service life

is achieved. A typical arrangement with a cylindrical roller bearing at the non-locating side is shown in **fig 1**.

The choice between the NU and N designs should take arrangement design and mounting procedures into consideration. N design bearings are preferred for high-speed applications or where idling under very light loads is to be expected.

In most applications cylindrical roller bearings with a cylindrical bore are used. Bearings with a tapered bore are required for a limited number of applications.

The **matrix** provides an overview of the suitability of the different cylindrical roller bearing standard designs for given application conditions.

Fig 1

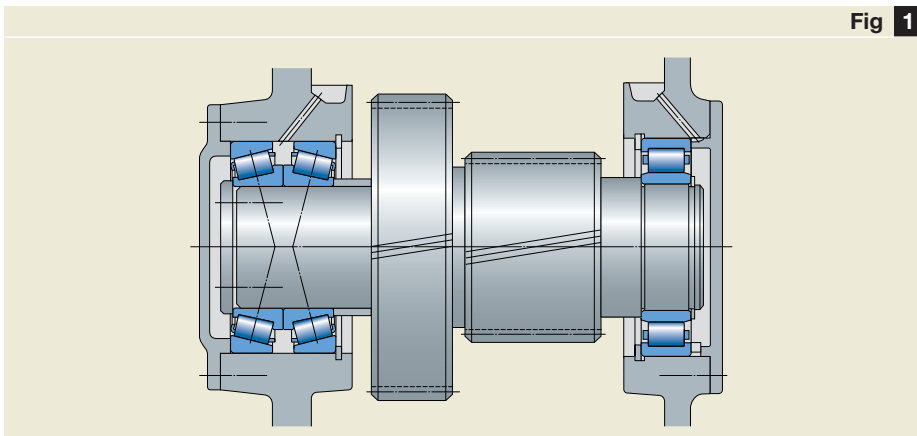

NU type cylindrical roller bearing as non-locating bearing on a gear shaft

Overview of the characteristics of the various standard designs of single row cylindrical roller bearings

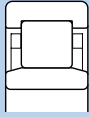
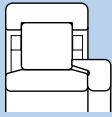
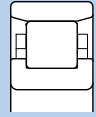
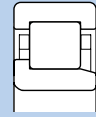
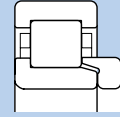
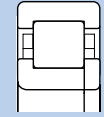
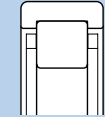
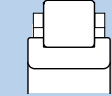
Characteristics		Standard designs								Matrix
										
Suitability of bearing for	Cage design	NU	NU + HJ	N	NJ	NJ + HJ	NUP	RNU	RN	
Radial loads	All	+++	+++	+++	+++	+++	+++	+++ ■	+++ ■	
Combined loads	All	--	+ ←	--	+ ←	+ ↔	+ ↔	--	--	
Non-locating positions	All	+++	++ ←	+++	++ ←	--	--	+++	+++	
Locating positions	All	--	+ ←	--	+ ←	+ ↔	+ ↔	--	--	
High running accuracy	All	+++	++	+++	++	++	++	+++ ■	+++ ■	
Loads smaller than minimum load	P	-	-	+	-	-	-	-	+	
High speeds + grease lubrication	P, M	++	++	++	++	++	++	++	++	
	J	+	+	●	+	+	+	+	●	
	MA, ML, MP	-	-	-	-	-	-	-	-	
High speeds + oil lubrication	P, M	++	++	++	++	++	++	++	++	
	J	+	+	●	+	+	+	+	●	
	MA, ML, MP	+++	+++	+++	+++	+++	+++	+++	+++	
High accelerations	P, M	+	+	+	+	+	+	+	+	
	J	-	-	●	-	-	-	-	●	
	MA, ML, MP	+++	+++	+++	+++	+++	+++	+++	+++	
High radial accelerations + vibrations	P, M	-	-	-	-	-	-	-	-	
	J	+	+	●	+	+	+	+	●	
	MA, ML, MP	+++	+++	+++	+++	+++	+++	+++	+++	
High operating temperatures	P	-	-	-	-	-	-	-	-	
	J	++	++	●	++	++	++	++	●	
	M, ML, MP	++	++	++	++	++	++	++	++	

Symbols:
 +++ eminently suitable
 ++ very suitable
 + suitable
 - less suitable
 -- unsuitable
 ← in one direction
 ↔ in both directions
 ● not applicable
 ■ presupposes shaft or housing raceway of bearing quality

Cages:
J Pressed steel cage, roller centred
M Two-piece machined brass cage, roller centred
MA Two-piece machined brass cage, outer-ring centred
ML One-piece form-turned window-type brass cage, inner or outer ring centred
MP One-piece window-type brass cage with milled, reamed or broached pockets, inner or outer ring centred
P Injection moulded cage of glass fibre reinforced polyamide 6,6, roller centred

Mounting and dismounting

Cylindrical roller bearings are precision mechanical components that should be handled with care during mounting and dismounting. This includes using the correct methods and the appropriate tools. To realize maximum bearing service life, SKF has a full line of mounting, dismounting and maintenance tools for nearly every purpose. Full information can be found in the catalogue MP3000 "SKF Maintenance and Lubrication Products" or online at www.skf.com. Additional information about how to mount and dismount single row cylindrical roller bearings can also be found at www.skf/mount.com.

Mounting

The inner and outer rings of cylindrical roller bearings are mounted separately. This simplifies mounting as interference fits are generally prescribed for both rings.

If the required interference is not too great, the rings of small cylindrical roller bearings can usually be mounted using a mechanical fitting tool, such as the SKF TMFT bearing fitting tool. Large numbers of bearings are generally mounted using mechanical or hydraulic presses.

The rings of larger bearings are seldom mounted in the cold state. The inner ring and – if possible – the housing must therefore be heated prior to mounting. SKF induction heaters (→ **fig 1**) are suitable for heating inner rings to some 60 to 80 °C above ambient temperature. Hotplates as well as aluminium heating rings specially

designed for heating the inner ring of cylindrical roller bearings (→ **fig 8**) can also be used.

When assembling the removable ring and the ring with roller and cage assembly, the shaft or the housing should be turned slowly (→ **fig 2**). Skewing the rings must be prevented (→ **fig 3**), as otherwise the rollers and raceways may be damaged. Where series mounting or large bearings are involved, a mounting sleeve is often used (→ **fig 4**). The sleeve should have the same diameter as the raceway diameter F of the inner ring and machined to tolerance $d10$.

An induction heater for safely heating inner rings



Rotate the shaft or housing during assembly

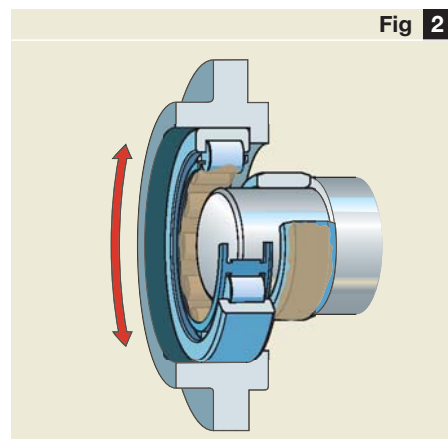

Care must be taken that shaft and housing are correctly aligned to avoid scoring the raceways

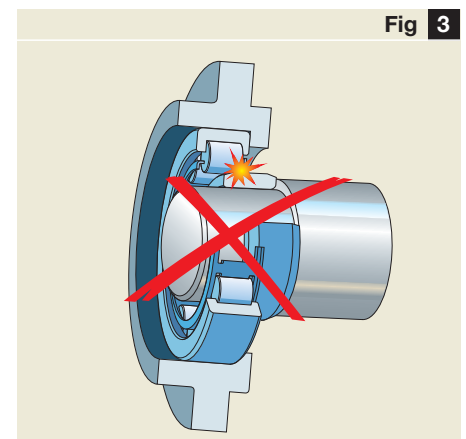

Dismounting

If the bearings are to be reused after inspection, they must be dismantled as carefully as they were mounted.

Dismounting an outer ring is easier if tapped holes are provided in the housing shoulders to take withdrawal screws (→ fig 5).

The inner ring of a cylindrical roller bearing can be dismantled mechanically or with heat.

The inner ring of small bearings and the inner ring with roller and cage assembly of N-type bearings can be removed using mechanical withdrawal tools. This can be performed with

- a jaw puller, if the shaft is pre-machined (→ fig 6) or
- a strong back puller such as SKF TMBS pullers, when there is enough space behind (→ fig 7).

Special heaters have been developed to dismount the inner rings of cylindrical roller bearings having no flanges or only one flange. They heat the inner ring rapidly without appreciably heating the shaft, so that the expanded inner ring can be removed easily.

If inner rings do not have to be removed frequently, or if larger sizes of inner rings (up to approximately 400 mm bore diameter) have to be dismantled the use of an aluminium heating ring is the preferred method. This tool consists of a slotted ring with

The use of a mounting sleeve facilitates the assembly of a larger number of bearings

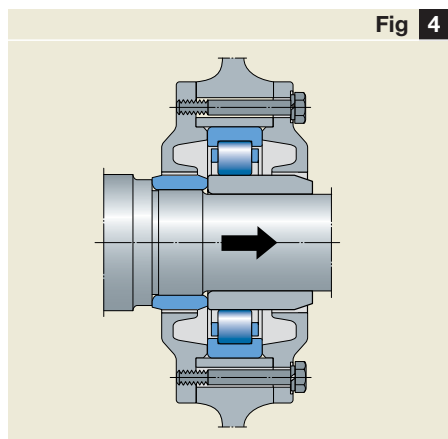

handles (→ fig 8) that is simple and easy-to-use and avoids shaft and inner ring damage.

The use of electric withdrawal tools becomes economic when bearings of the same size are frequently mounted and dismantled. These electrical induction heaters have one or more coils energized by alternating current. It is necessary to demagnetize the inner rings after heating and removal.

Pullers, heaters and heating rings are available from SKF. Additional information can be found in the catalogue MP3000 “SKF Maintenance and Lubrication Products” or online at www.skf.com.

Outer rings can be removed more easily if tapped holes are provided in the housing shoulder

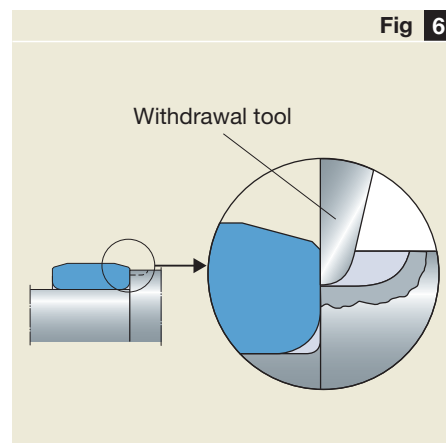
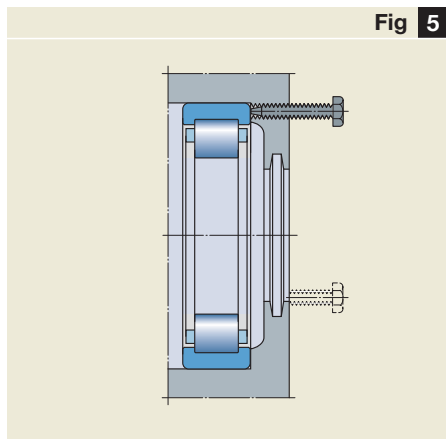

Notches pre-machined in the shaft shoulder that accommodate puller arms eliminate the risk of damaging the inner ring or seating

The SKF TMBS strong back puller is supplied in kit form to cover the most difficult pulling operations

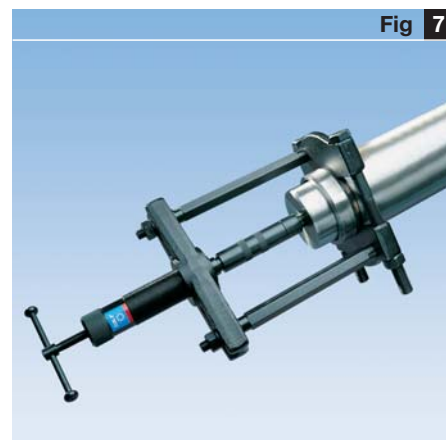

The SKF TMBR series aluminium heating ring is an economic, easy-to-use tool to mount and dismount inner rings



Lubrication and handling

Lubrication

SKF cylindrical roller bearings can be lubricated with grease or oil. There is no strict boundary where one type of lubricant is more appropriate than the other. The upper temperature limit for greases based on mineral oils is about 120 °C for continuous operation. The limit is much higher for oil lubrication and even higher if synthetic oils are used, provided that the cage and other components of the bearing arrangement can withstand the higher temperatures.

The advantage of grease over oil is that grease is more easily retained in the bearing arrangement. This is particularly important in applications where the bearing axes are vertical or at an angle.

On the other hand, oil lubrication allows operation at higher speeds and temperatures and contributes to the removal of frictional or applied heat from the bearing position.

SKF cylindrical roller bearings with an injection moulded cage of glass fibre reinforced polyamide 6,6 are particularly suited to grease lubrication. The special cage bar design enables the build-up of a grease reservoir by adhesion. This allows maintenance intervals to be extended, good performance under emergency conditions and help to prevent bearing seizure under lubrication starvation.

The greases generally recommended for cylindrical roller bearings have a consistency of 2 and may contain EP additives. Where the bearings are subjected to axial loads, the grease should have an oil bleed to DIN 51817:1998 (IP 121/75:1992) of approximately 3 %. For this reason, high-temperature greases should only be used when the operating temperature is always above +80 °C. Similarly, greases with a consistency of 3 should only be used if, for example, strong vibrations favour distribution of the grease.

To enhance the operational reliability of axially loaded cylindrical roller bearings SKF recommends using a grease or oil with a viscosity that is at least 1,5 times the requisite viscosity for the operating temperature (viscosity ratio $\kappa = \nu/\nu_1 \geq 1,5$). If an axial load is applied for long periods (> 1 h), the relubrication intervals should be shortened.

Bearing handling

Before packaging, SKF cylindrical roller bearings are treated with a rust-inhibiting medium and can be stored for several years in their original packages. The bearings should be stored lying down, preferably in rooms that are free from vibration, have a relative humidity that does not exceed 60 % and where the temperature is reasonably constant.

When purchasing, make sure that the SKF cylindrical roller bearings are in their original packages (→ **page 13**). A single bearing package cannot be opened without breaking the seal, this proves that the bearing is in “mint” condition and has not been exposed to undesirable environmental conditions.

Comprehensive support for long-term success

Why not profit from SKF competence? Decades of experience in almost all branches of industry have enabled SKF to establish expertise in improving machine performance and productivity that can be shared with customers and bearing users. SKF Total Shaft Solutions™ can provide

- failure analysis and root cause elimination,
- engineering consultancy for all rotating components,
- products, services and systems, and
- machine condition diagnoses.

Another SKF concept that takes an even wider view of customer-related technologies and competencies is known as Asset Efficiency Optimization™ (AEO) and focuses, as the name suggests, on considering machines and plants as assets and optimizing their efficiency.

The AEO concept from SKF picks up where most plant asset management programmes typically stop. Using this concept enables a plant to produce the same amount for less cost, or to produce more for the same costs. It is a system for organizing and applying

assets – from personnel to machinery – bringing together knowledge and technology to achieve the greatest return on investment. It covers

- condition-dependent maintenance,
- proactive maintenance for reliability enhancement,
- maintenance service and
- integrated maintenance concepts.

More information on the SKF competencies and services can be obtained from the local SKF representative.



Bearing data - general

Designs

SKF single row cylindrical roller bearings with a cage guided roller complement are produced in many different designs. The most popular ones (→ fig 1)

- NU design (a)
- N design (b)
- NJ design (c)
- NUP design (d)

are described on **page 7** and listed in the product table.

Angle rings

Angle rings, series designation HJ (→ fig 2), are designed to fit

- NU-design bearings (a)
- NJ-design bearings (b).

The HJ angle rings, where available, are listed in the product table with their designation and dimensions together with the relevant bearing. Detailed information on angle rings can be found on **page 9**.

SKF Explorer class bearings

Cylindrical roller bearings in the SKF Explorer performance class are listed in blue in the product table. SKF Explorer bearings retain the designation of earlier standard bearings, e.g. NU 216 ECP. However, each bearing and its box are marked with the name "EXPLORER", to avoid confusion.

Dimensions

The dimensions of SKF single row cylindrical roller bearings are in accordance with ISO 15:1998.

The dimensions of the HJ angle rings correspond to those specified in ISO 246:1995.

Tolerances

SKF single row cylindrical roller bearings are manufactured to Normal tolerances for dimensional accuracy and to P6 for running accuracy as standard.

The tolerances correspond to those specified in ISO 492:2002 and can be found in the SKF General Catalogue or the SKF Interactive Engineering Catalogue, available on CD-ROM or online at www.skf.com.

Standard bearing designs

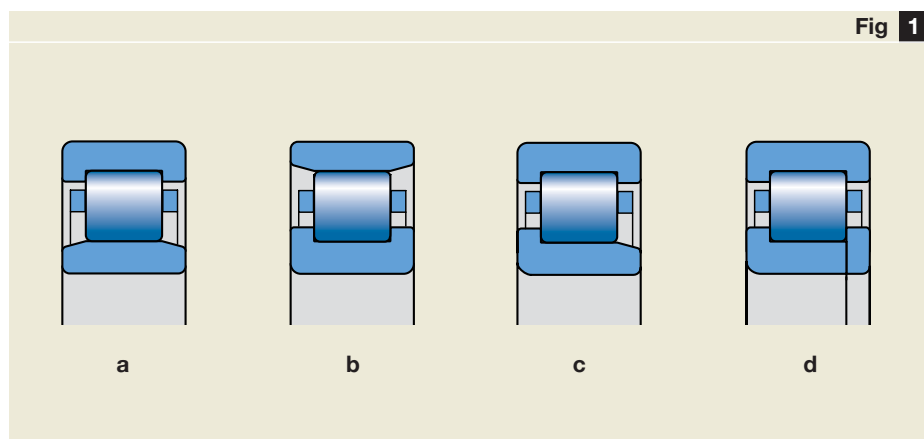

Bearings with an angle ring

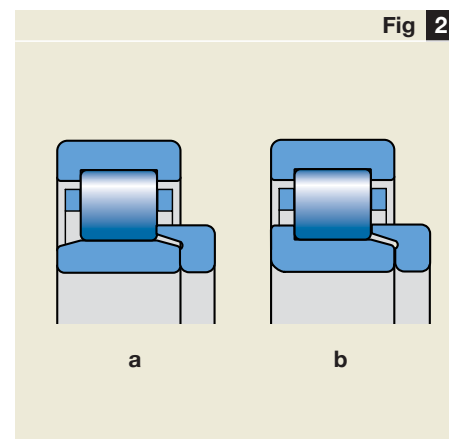
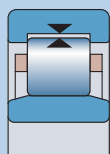

Table 1

**Radial internal clearance**

SKF single row cylindrical roller bearings are manufactured with Normal radial internal clearance as standard. Most of the bearings are also available with C3 radial internal clearance. Some of the bearings can even be supplied with the smaller C2 or the appreciably greater C4 clearance. In addition some bearings are produced with special reduced clearances. This special clearance corresponds to a section of a standard clearance range or to sections of two adjacent clearance ranges.

Bearings with non-standard clearance or with the special reduced clearances can be supplied to special order.

The actual clearance limits for bearings with a cylindrical bore are provided in **table 1** and are in accordance with ISO 5753:1991. They are valid for unmounted bearings under zero measuring load.

The separable components of all SKF bearings with standard clearance as well as those with reduced clearance are interchangeable.

Bore diameter		Radial internal clearance									
d	incl.	C2		Normal		C3		C4		C5	
over		min	max	min	max	min	max	min	max	min	max
mm		µm									
-	24	0	25	20	45	35	60	50	75	65	90
24	30	0	25	20	45	35	60	50	75	70	95
30	40	5	30	25	50	45	70	60	85	80	105
40	50	5	35	30	60	50	80	70	100	95	125
50	65	10	40	40	70	60	90	80	110	110	140
65	80	10	45	40	75	65	100	90	125	130	165
80	100	15	50	50	85	75	110	105	140	155	190
100	120	15	55	50	90	85	125	125	165	180	220
120	140	15	60	60	105	100	145	145	190	200	245
140	160	20	70	70	120	115	165	165	215	225	275
160	180	25	75	75	125	120	170	170	220	250	300
180	200	35	90	90	145	140	195	195	250	275	330
200	225	45	105	105	165	160	220	220	280	305	365
225	250	45	110	110	175	170	235	235	300	330	395
250	280	55	125	125	195	190	260	260	330	370	440
280	315	55	130	130	205	200	275	275	350	410	485
315	355	65	145	145	225	225	305	305	385	455	535
355	400	100	190	190	280	280	370	370	460	510	600
400	450	110	210	210	310	310	410	410	510	565	665
450	500	110	220	220	330	330	440	440	550	625	735
500	560	120	240	240	360	360	480	480	600	690	810
560	630	140	260	260	380	380	500	500	620	780	900
630	710	145	285	285	425	425	565	565	705	865	1 005
710	800	150	310	310	470	470	630	630	790	975	1 135
800	900	180	350	350	520	520	690	690	860	1 095	1 265

Radial internal clearance of cylindrical roller bearings with a cylindrical bore

Table 2

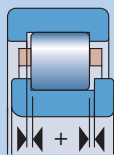

Bearing Bore diameter	Size code	Axial internal clearance of bearings in the series							
		NUP 2		NUP 3		NUP 22		NUP 23	
mm	–	µm							
		min	max	min	max	min	max	min	max
15	02	–	–	–	–	–	–	–	–
17	03	37	140	37	140	37	140	47	155
20	04	37	140	37	140	47	155	47	155
25	05	37	140	47	155	47	155	47	155
30	06	37	140	47	155	47	155	47	155
35	07	47	155	47	155	47	155	62	180
40	08	47	155	47	155	47	155	62	180
45	09	47	155	47	155	47	155	62	180
50	10	47	155	47	155	47	155	62	180
55	11	47	155	62	180	47	155	62	180
60	12	47	155	62	180	62	180	87	230
65	13	47	155	62	180	62	180	87	230
70	14	47	155	62	180	62	180	87	230
75	15	47	155	62	180	62	180	87	230
80	16	47	155	62	180	62	180	87	230
85	17	62	180	62	180	62	180	87	230
90	18	62	180	62	180	62	180	87	230
95	19	62	180	62	180	62	180	87	230
100	20	62	180	87	230	87	230	120	315
105	21	62	180	–	–	–	–	–	–
110	22	62	180	87	230	87	230	120	315
120	24	62	180	87	230	87	230	120	315
130	26	62	180	87	230	87	230	120	315
140	28	62	180	87	230	87	230	120	315
150	30	62	180	–	–	87	230	120	315
160	32	87	230	–	–	–	–	–	–
170	34	87	230	–	–	–	–	–	–
180	36	87	230	–	–	–	–	–	–
190	38	87	230	–	–	–	–	–	–
200	40	87	230	–	–	–	–	–	–
220	44	95	230	–	–	–	–	–	–
240	48	95	250	–	–	–	–	–	–
260	52	95	250	–	–	–	–	–	–

Axial internal clearance

NUP-design cylindrical roller bearings, which can locate a shaft axially in both directions, are manufactured with an axial internal clearance as shown in table 2. The axial internal clearance of NJ-design bearings when combined with an HJ angle ring is specified in table 3.

The clearance limits quoted in tables 2 and 3 should be considered as guideline values. When axial internal clearance is measured, the rollers may tilt, causing an enlargement of the axial clearance, which may be as much as

- the radial internal clearance of bearings in the 2, 3 and 4 series or
- 2/3 of the radial internal clearance for bearings in the 22 and 23 series.

Axial internal clearance of NUP cylindrical roller bearings

Axial displacement

Cylindrical roller bearings with flangeless inner or outer rings, NU- and N-designs, and NJ-design bearings with one integral flange at the inner ring, can accommodate axial displacement of the shaft with respect to the housing as a result of thermal expansion within certain limits (→ fig 3). As axial displacement takes place within the bearing and not between the ring and shaft or housing bore, there is practically no increase in friction as the bearing rotates. Values for the permissible axial displacement “s” from the normal position of one bearing ring relative to the other are listed in the product table.

Influence of operating temperature on bearing material

SKF cylindrical roller bearings undergo a special heat treatment. When fitted with a steel or brass cage, they can be used at temperatures of up to +150 °C.

Misalignment

The ability of single row cylindrical roller bearings to accommodate angular misalignment of the inner ring with respect to the outer ring is limited to a few minutes of arc. The actual values are

- 4 minutes of arc for bearings in the narrow 2, 3, 4, 10 and 12 series and
- 3 minutes of arc for bearings in the 20, 22 and 23 series.

These guideline values apply to non-locating bearings, provided the positions of the shaft and housing axes remain constant. Larger misalignments may be possible but may result in shorter bearing service life. In these

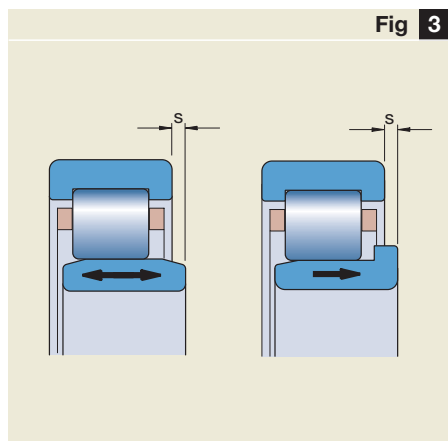

Table 3

Bearing Bore diameter	Size code	Axial internal clearance of bearings in the series									
		NJ 2+HJ		NJ 3+HJ		NJ 4+HJ		NJ 22+HJ		NJ 23+HJ	
mm	-	µm									
15	02	42	165	42	165	-	-	-	-	-	-
17	03	42	165	42	165	-	-	42	165	52	183
20	04	42	165	42	165	-	-	52	185	52	183
25	05	42	165	52	185	-	-	52	185	52	183
30	06	42	165	52	185	60	200	52	185	52	183
35	07	52	185	52	185	60	200	52	185	72	215
40	08	52	185	52	185	60	200	52	185	72	215
45	09	52	185	52	185	60	200	52	185	72	215
50	10	52	185	52	185	80	235	52	185	72	215
55	11	52	185	72	215	80	235	52	185	72	215
60	12	52	185	72	215	80	235	72	215	102	275
65	13	52	185	72	215	80	235	72	215	102	275
70	14	52	185	72	215	80	235	72	215	102	275
75	15	52	185	72	215	80	235	72	215	102	275
80	16	52	185	72	215	80	235	72	215	102	275
85	17	72	215	72	215	110	290	72	215	102	275
90	18	72	215	72	215	110	290	72	215	102	275
95	19	72	215	72	215	110	290	72	215	102	275
100	20	72	215	102	275	110	290	102	275	140	375
105	21	72	215	102	275	110	290	102	275	140	375
110	22	72	215	102	275	110	290	102	275	140	375
120	24	72	215	102	275	110	310	102	275	140	375
130	26	72	215	102	275	110	310	102	275	140	375
140	28	72	215	102	275	140	385	102	275	140	375
150	30	72	215	102	275	140	385	102	275	140	375
160	32	102	275	102	275	-	-	140	375	140	375
170	34	102	275	-	-	-	-	140	375	-	-
180	36	102	275	-	-	-	-	140	375	-	-
190	38	102	275	-	-	-	-	-	-	-	-
200	40	102	275	-	-	-	-	-	-	-	-
220	44	110	290	-	-	-	-	-	-	-	-
240	48	110	310	-	-	-	-	-	-	-	-
260	52	110	310	-	-	-	-	-	-	-	-
280	56	110	310	-	-	-	-	-	-	-	-

Axial internal clearance of NJ cylindrical roller bearings + HJ angle ring

Axial displacement

cases, it is advisable to contact the SKF application engineering service.

When the bearings are used to locate the shaft axially, the guideline values must be reduced, as uneven flange loading can lead to increased wear and possibly even to flange fracture.

The maximum values for misalignment do not apply to NUP bearings or NJ bearings with an HJ angle ring. Because these bearings have two inner and two outer ring flanges and the axial internal clearance is relatively small, axial stresses may be induced in the bearing. In case of doubt, please contact the SKF application engineering service.

Cages

Depending on their size and design, SKF single row cylindrical roller bearings are equipped as standard with one of the cages described below and shown in **fig 4**. Bearings included in the SKF standard programme are also available with a choice of up to four different cages (**→ product table**).

The various cages used for single row cylindrical roller bearings are

- injection moulded cage of glass fibre reinforced polyamide 6,6, roller centred, designation suffix P (**a**),
- unhardened pressed steel cage, roller centred, designation suffix J or no suffix (**b**),
- one-piece window-type brass cage, inner or outer ring centred, designation suffixes ML and MP (**c**),
- two-piece machined brass cage, roller centred, designation suffix M, or outer ring centred, designation suffix MA, or inner ring centred, designation suffix MB (**d**).

Note

Bearings with a polyamide cage can be operated at temperatures up to +120 °C. The lubricants generally used for rolling bearings do not have a detrimental effect on cage properties, with the exception for a few synthetic oils and greases with synthetic base oil as well as some lubricants containing a high proportion of EP additives when used at elevated temperatures.

For bearing arrangements, which are to operate at continuously high temperatures or under difficult conditions, the use of bearings with metallic cages is recommended. For applications using refrigerants such as ammonia or freon replacements, bearings with a polyamide cage can be used for operating temperatures up to 70 °C. At higher operating temperatures bearings incorporating a machined brass or steel cage should be used.

For demanding applications, like compressors, the use of glass fibre reinforced PEEK cages is common. The exceptional properties of PEEK are a superior combination of strength and flexibility, high operating temperature range, high chemical and wear resistance and good processability.

Standard cages

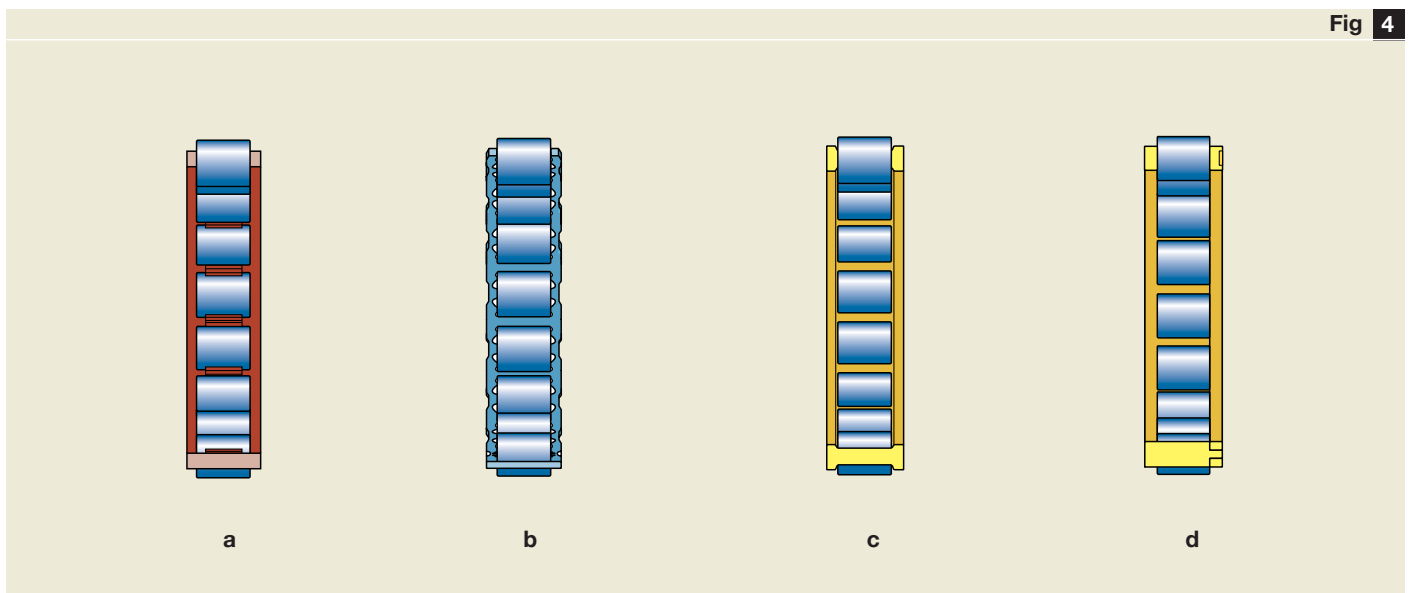

Fig 4

Speed ratings

The limiting speed is determined by criteria that include the form stability and strength of the cage, lubrication of the cage guiding surfaces, centrifugal and gyratory forces acting on the rolling elements, precision etc.

The values listed in the product table are valid for the appropriate standard cage. To estimate the limiting speed for bearings with an alternative cage, **table 4** provides the appropriate conversion factors.

Bearings with an outer ring centred brass cage are not particularly suited for grease lubrication. If grease lubricated, they should not be used at speeds higher than $n \times d_m = 250\,000$ mm/min and the relubrication intervals should be shortened.

Detailed information on reference and limiting speeds can be found in the SKF General Catalogue or the SKF Interactive Engineering Catalogue, available on CD-ROM or online at www.skf.com.

Minimum load

In order to provide satisfactory operation, single row cylindrical roller bearings, like all ball and roller bearings, must always be subjected to a given minimum load, particularly if they are to operate at high speeds or are subjected to high accelerations or rapid changes in the direction of load. Under such conditions, the inertia forces of the rollers and cage, and the friction in the lubricant, can have a detrimental

influence on the rolling conditions in the bearing arrangement and may cause damaging sliding movements to occur between the rollers and raceways.

The requisite minimum load to be applied to single row cylindrical roller bearings can be estimated using

$$F_{rm} = k_r \left(6 + \frac{4n}{n_r} \right) \left(\frac{d_m}{100} \right)^2$$

where

F_{rm} = minimum radial load, kN

k_r = minimum load factor
(→ product table)

n = rotational speed, r/min

n_r = reference speed, r/min
(→ product table)

d_m = bearing mean diameter
= 0,5 (d + D), mm

When starting up at low temperatures or when the lubricant is highly viscous, even greater minimum loads may be required. The weight of the components supported by the bearing, together with external forces, generally exceeds the requisite minimum load. If this is not the case, the single row cylindrical roller bearing must be subjected to an additional radial load.

Table 4

Bearing with standard cage	alternative standard cage		
	P, J, M, MR	MA, MB	ML, MP
P, J, M, MR	1	1,3	1,5
MA, MB	0,75	1	1,2
ML, MP	0,65	0,85	1

Conversion factors for limiting speeds

Dynamic axial load carrying capacity

Bearings with flanges on both the inner and outer ring can support axial loads in addition to radial loads. Their axial load carrying capacity is primarily determined by the ability of the sliding surfaces of the roller end/flange contact to support loads. Factors having the greatest effect on this ability are the lubrication conditions, operating temperature and heat dissipation from the bearing.

Assuming the conditions cited below, the permissible axial load can be calculated with sufficient accuracy from

$$F_{ap} = \frac{k_1 C_0 10^4}{n (d + D)} - k_2 F_r$$

where

F_{ap} = maximum permissible axial load, kN

C_0 = basic static load rating, kN

F_r = actual radial bearing load, kN

n = rotational speed, r/min

d = bearing bore diameter, mm

D = bearing outside diameter, mm

k_1 = a factor

= 1,5 for oil lubrication

= 1 for grease lubrication

k_2 = a factor

= 0,15 for oil lubrication

= 0,1 for grease lubrication

Bearings subjected to axial loads should be supported to a height corresponding to half of the flange height

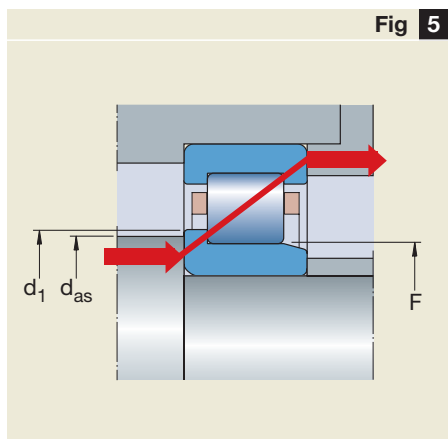

Fig 5

The above equation is based on conditions that are considered typical for normal bearing operation:

- a difference of 60 °C between the bearing operating temperature and the ambient temperature;
- a specific heat loss from the bearing of 0,5 mW/mm² °C; with reference to the bearing outside diameter surface ($\pi D B$);
- a viscosity ratio $\kappa \geq 2$.

For grease lubrication the viscosity of the base oil in the grease may be used. If κ is less than 2, the friction will increase and there will be more wear. These effects can be reduced at low speeds, for example, by using oils with AW (anti-wear) and EP (extreme pressure) additives.

Where axial loads act for longer periods and the bearings are grease lubricated, it is advisable to use grease that has good oil bleeding properties at the operating temperatures (> 3 % according to DIN 51 817 or IP 12175/1992). Frequent relubrication is also recommended.

The values of the permissible load F_{ap} obtained from the heat balance equation are valid for a continuously acting constant axial load and adequate lubricant supply to the roller end/flange contacts. Where axial loads act only for short periods, the values may be multiplied by 2, or for axially acting shock loads by 3.

To avoid any risk of flange breakage, the constantly acting axial load F_a applied to the bearing should never exceed the numerical value of

- 0,0045 $D^{1,5}$ for bearings of series 2 and
- 0,0023 $D^{1,7}$ for bearings of other series.

Where the axial load acts only occasionally and for brief periods, F_a should never be greater than the numerical value of

- 0,013 $D^{1,5}$ for bearings of series 2 and
- 0,007 $D^{1,7}$ for bearings of other series

where

F_a = the occasionally acting axial load, kN

D = bearing outside diameter, mm

To obtain an even flange load and provide sufficient running accuracy of the shaft when cylindrical roller bearings are subjected to heavy axial loads, axial runout and the size of the abutment surfaces of adjacent components become particularly important. As to the diameter of the abutment surfaces, SKF recommends supporting the inner ring at a height corresponding to half of the flange height (→ fig 5). For the inner ring flange, for example, the abutment diameter can be obtained using

$$d_{as} = 0,5 (d_1 + F)$$

where

d_{as} = shaft abutment diameter, mm

d_1 = inner ring flange diameter, mm

F = inner ring raceway diameter, mm

Where misalignment between the inner and outer rings exceeds 1 minute of arc, the action of the load on the flange changes so considerably that the safety factors included in the guideline values may be inadequate. In these cases, please contact the SKF application engineering service.

Supplementary designations

The designation suffixes used to identify certain features of SKF single row cylindrical roller bearings are explained in the following.

CN	Normal radial internal clearance; generally only appears in connection with one of the following letters for reduced or displaced clearance range
H	Reduced clearance range corresponding to the upper half of the actual range
L	Reduced clearance range corresponding to the lower half of the actual range
	The above letters are also used together with the clearance class suffixes C2, C3 and C4
C2	Radial internal clearance smaller than Normal
C3	Radial internal clearance greater than Normal
C4	Radial internal clearance greater than C3
C5	Radial internal clearance greater than C4
EC	Optimized internal design incorporating more and/or larger rollers and with modified roller end/flange contact
HA3	Inner ring of case-hardening steel
HB1	Bainite hardened inner and outer ring
HN1	Inner and outer ring with special surface "enriched" heat treatment
J	Pressed steel cage, roller centred, unhardened
K	Tapered bore, taper 1:12
M	Two-piece machined brass cage, roller centred
MA	Two-piece machined brass cage, outer ring centred
MB	Two-piece machined brass cage, inner ring centred
ML	One-piece form-turned window-type brass cage, inner or outer ring centred
MP	One-piece window-type brass cage with milled, reamed or broached pockets, inner or outer ring centred
MR	One-piece form-turned window-type brass cage, roller centred

N	Snap ring groove in the outer ring outside diameter
NR	Snap ring groove in the outer ring, with snap ring
N1	One locating slot in one outer ring side face
N2	Two locating slots 180° apart in one outer ring side face
P	Injection moulded cage of glass fibre reinforced polyamide 6,6, roller centred
PH	Injection moulded PEEK cage, roller centred
PHA	Injection moulded PEEK cage, outer ring centred
S1	Rings dimensionally stabilized for operating temperatures up to +200 °C
S2	Rings dimensionally stabilized for operating temperatures up to +250 °C
VA301	Bearing for railway vehicle traction motors
VA305	VA301 + special inspection routines
VA3091	VA301 + VL0241
VA350	Bearing for railway axleboxes
VA820	Bearing for railway axleboxes according to EN 12080:1998, class 1
VC025	Bearing with specially wear-resistant raceways for applications in heavily contaminated environments
VL0241	Aluminium-oxide coated outside surface of the outer ring for electrical resistance up to 1 000 V DC
VL2071	Aluminium-oxide coated outside surface of the inner ring for electrical resistance up to 1 000 V DC
VQ015	Inner ring with crowned raceway for increased permissible misalignment

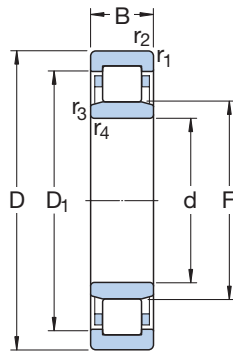

Type NU

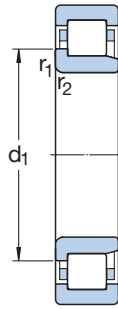

Type NJ

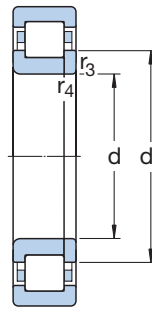

Type NUP

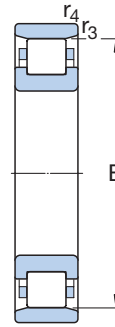

Type N

Principal dimensions			Basic load ratings		Fatigue load limit P _u	Speed ratings		Mass Bearing with standard cage	Designations Bearing with standard cage	Alternative standard cage designs ¹⁾	
d	D	B	C	C ₀		Reference speed	Limiting speed				
mm			kN		kN	r/min		kg	-		
15	35	11	12,5	10,2	1,22	22 000	26 000	0,047	NU 202 ECP	-	
	35	11	12,5	10,2	1,22	22 000	26 000	0,049	NJ 202 ECP	-	
17	40	12	17,2	14,3	1,73	19 000	22 000	0,068	NU 203 ECP	ML	
	40	12	17,2	14,3	1,73	19 000	22 000	0,070	NJ 203 ECP	ML	
	40	12	17,2	14,3	1,73	19 000	22 000	0,073	NUP 203 ECP	ML	
	40	12	17,2	14,3	1,73	19 000	22 000	0,066	N 203 ECP	-	
	40	16	23,8	21,6	2,65	19 000	22 000	0,092	NU 2203 ECP	-	
	40	16	23,8	21,6	2,65	19 000	22 000	0,095	NJ 2203 ECP	-	
	40	16	23,8	21,6	2,65	19 000	22 000	0,097	NUP 2203 ECP	-	
	47	14	24,6	20,4	2,55	15 000	20 000	0,12	NU 303 ECP	-	
	47	14	24,6	20,4	2,55	15 000	20 000	0,12	NJ 303 ECP	-	
	47	14	24,6	20,4	2,55	15 000	20 000	0,12	N 303 ECP	-	
	20	47	14	25,1	25,2	2,75	16 000	19 000	0,11	NU 204 ECP	ML
		47	14	25,1	25,2	2,75	16 000	19 000	0,11	NJ 204 ECP	ML
47		14	25,1	25,2	2,75	16 000	19 000	0,12	NUP 204 ECP	ML	
47		14	25,1	25,2	2,75	16 000	19 000	0,11	N 204 ECP	-	
47		18	29,7	27,5	3,45	16 000	19 000	0,14	NU 2204 ECP	-	
47		18	29,7	27,5	3,45	16 000	19 000	0,14	NJ 2204 ECP	-	
52		15	35,5	26	3,25	15 000	18 000	0,17	NU 304 ECP	-	
52		15	35,5	26	3,25	15 000	18 000	0,17	NJ 304 ECP	-	
52		15	35,5	26	3,25	15 000	18 000	0,16	NUP 304 ECP	-	
52		15	35,5	26	3,25	15 000	18 000	0,15	N 304 ECP	-	
25	52	21	47,5	38	4,8	14 000	18 000	0,21	NU 2304 ECP	-	
	52	21	47,5	38	4,8	14 000	18 000	0,22	NJ 2304 ECP	-	
	52	21	47,5	38	4,8	14 000	18 000	0,22	NUP 2304 ECP	-	
	47	12	14,2	13,2	1,4	18 000	18 000	0,084	NU 1005	-	
	52	15	28,6	27	3,35	14 000	16 000	0,14	NU 205 ECP	J, ML	
	52	15	28,6	27	3,35	14 000	16 000	0,15	NJ 205 ECP	J, ML	
	52	15	28,6	27	3,35	14 000	16 000	0,14	NUP 205 ECP	ML	
	52	15	28,6	27	3,35	14 000	16 000	0,13	N 205 ECP	-	
	52	18	34,1	34	4,25	14 000	16 000	0,17	NU 2205 ECP	ML	
52	18	34,1	34	4,25	14 000	16 000	0,18	NJ 2205 ECP	ML		
52	18	34,1	34	4,25	14 000	16 000	0,17	NUP 2205 ECP	ML		

The designations of SKF Explorer class bearings are printed in blue

¹⁾ When ordering bearings with an alternative standard cage the suffix of the standard cage has to be replaced by the suffix of the cage in question. e.g. NU 203 ECP becomes NU 203 ECML

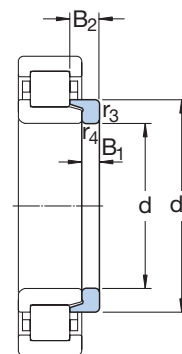
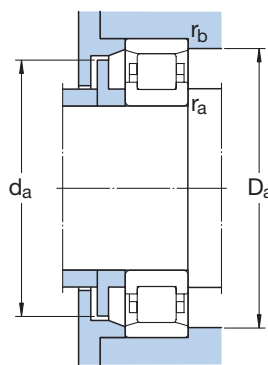
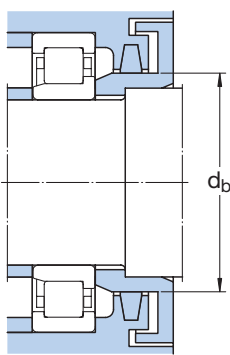
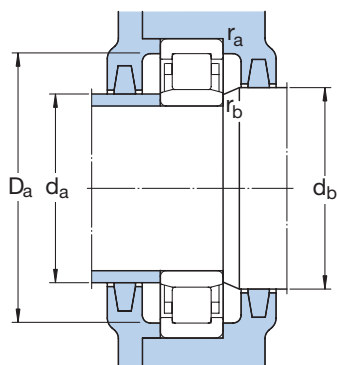

Angle ring

3

Dimensions							Abutment and fillet dimensions						Calculation factor k_r	Angle ring Designation	Mass	Dimensions	
d	d_1 ~	D_1 ~	F, E	$r_{1,2}$ min	$r_{3,4}$ min	$s^1)$	d_a min	d_a max	d_b, D_a min	D_a max	r_a max	r_b max				B ₁	B ₂
mm							mm						-	-	kg	mm	
15	-	27,9	19,3	0,6	0,3	1	17,4	18,5	21	30,8	0,6	0,3	0,15	-			
	21,9	27,9	19,3	0,6	0,3	1	18,5	18,5	23	30,8	0,6	0,3	0,15	-			
17	-	32,4	22,1	0,6	0,3	1	19,4	21	24	35,8	0,6	0,3	0,15	-			
	25	32,4	22,1	0,6	0,3	1	21	21	27	35,8	0,6	0,3	0,15	-			
	25	32,4	22,1	0,6	0,3	-	21,2	-	27	35,8	0,6	0,3	0,15	-			
	25	-	35,1	0,6	0,3	1	21,2	33	37	37,6	0,6	0,3	0,15	-			
	-	32,4	22,1	0,6	0,3	1,5	19,4	21	24	35,8	0,6	0,3	0,2	-			
	25	32,4	22,1	0,6	0,3	1,5	21	21	27	35,8	0,6	0,3	0,2	-			
	25	32,4	22,1	0,6	0,3	-	21,2	-	27	35,8	0,6	0,3	0,2	-			
	-	37	24,2	1	0,6	1	21,2	23	26	41,4	1	0,6	0,15	-			
	27,7	37	24,2	1	0,6	1	22,6	23	29	41,4	1	0,6	0,15	-			
	27,7	-	40,2	1	0,6	1	22,6	38	42	42,8	1	0,6	0,15	-			
20	-	38,8	26,5	1	0,6	1	24,2	25	28	41,4	1	0,6	0,15	-			
	29,7	38,8	26,5	1	0,6	1	25	25	31	41,4	1	0,6	0,15	-			
	29,7	38,8	26,5	1	0,6	-	25,6	-	31	41,4	1	0,6	0,15	-			
	29,7	-	41,5	1	0,6	1	25,6	40	43	42,8	1	0,6	0,15	-			
	-	38,8	26,5	1	0,6	2	24,2	25	28	41,4	1	0,6	0,2	-			
	29,7	38,8	26,5	1	0,6	2	25	25	31	41,4	1	0,6	0,2	-			
	31,2	42,4	27,5	1,1	0,6	0,9	24,2	26	29	45	1	0,6	0,15	HJ 304 EC	0,017	4	6,5
	31,2	42,4	27,5	1,1	0,6	0,9	27	29	33	45	1	0,6	0,15	HJ 304 EC	0,017	4	6,5
	31,2	42,4	27,5	1,1	0,6	-	27	-	33	45	1	0,6	0,15	-			
	31,2	-	45,5	1,1	0,6	0,9	27	44	47	47,8	1	0,6	0,15	-			
	-	42,4	27,5	1,1	0,6	1,9	24,2	26	29	45	1	0,6	0,2	-			
	31,2	42,4	27,5	1,1	0,6	1,9	26	26	33	45	1	0,6	0,2	-			
	31,2	42,4	27,5	1,1	0,6	-	27	-	33	45	1	0,6	0,2	-			
	25	-	38,8	30,5	0,6	0,3	2	27	29	32	43,8	0,6	0,3	0,1	-		
34,7		43,8	31,5	1	0,6	1,3	29,2	30	33	46,4	1	0,6	0,15	HJ 205 EC	0,014	3	6
34,7		43,8	31,5	1	0,6	1,3	30	30	36	46,4	1	0,6	0,15	HJ 205 EC	0,014	3	6
34,7		43,8	31,5	1	0,6	-	30,6	-	36	46,4	1	0,6	0,15	-			
34,7		-	46,5	1	0,6	1,3	30,6	45	48	47,8	1	0,6	0,15	-			
34,7		43,8	31,5	1	0,6	1,8	29,2	30	33	46,4	1	0,6	0,2	HJ 2205 EC	0,014	3	6,5
34,7		43,8	31,5	1	0,6	1,8	30	30	36	46,4	1	0,6	0,2	HJ 2205 EC	0,014	3	6,5
34,7		43,8	31,5	1	0,6	-	30,6	-	36	46,4	1	0,6	0,2	-			

¹⁾ Permissible axial displacement from normal position of one ring in relation to the other

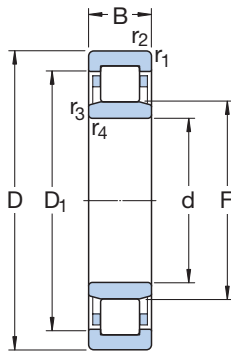

Type NU



Type NJ

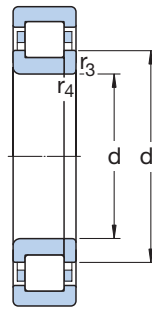

Type NUP

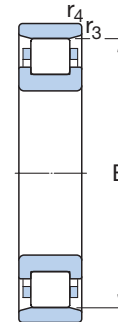

Type N

Principal dimensions			Basic load ratings		Fatigue load limit P _u	Speed ratings		Mass Bearing with standard cage	Designations Bearing with standard cage	Alternative standard cage designs ¹⁾	
d	D	B	C	C ₀		Reference speed	Limiting speed				
mm			kN		kN	r/min		kg	–		
25 cont.	62	17	46,5	36,5	4,55	12 000	15 000	0,28	NU 305 ECP	J, ML	
	62	17	46,5	36,5	4,55	12 000	15 000	0,29	NJ 305 ECP	J, ML	
	62	17	46,5	36,5	4,55	12 000	15 000	0,25	NUP 305 ECP	J, ML	
	62	17	46,5	36,5	4,55	12 000	15 000	0,24	N 305 ECP	–	
	62	24	64	55	6,95	12 000	15 000	0,38	NU 2305 ECP	J, ML	
	62	24	64	55	6,95	12 000	15 000	0,39	NJ 2305 ECP	ML	
	62	24	64	55	6,95	12 000	15 000	0,38	NUP 2305 ECP	ML	
	30	55	13	17,9	17,3	1,86	14 000	15 000	0,12	NU 1006	–
		62	16	44	36,5	4,55	13 000	14 000	0,23	NU 206 ECP	J, ML
		62	16	44	36,5	4,55	13 000	14 000	0,24	NJ 206 ECP	J, ML
		62	16	44	36,5	4,55	13 000	14 000	0,22	NUP 206 ECP	ML
		62	16	44	36,5	4,55	13 000	14 000	0,20	N 206 ECP	–
62		20	55	49	6,1	13 000	14 000	0,26	NU 2206 ECP	J, ML	
62		20	55	49	6,1	13 000	14 000	0,27	NJ 2206 ECP	J, ML	
62		20	55	49	6,1	13 000	14 000	0,27	NUP 2206 ECP	ML	
72		19	58,5	48	6,2	11 000	12 000	0,40	NU 306 ECP	J, M, ML	
72		19	58,5	48	6,2	11 000	12 000	0,41	NJ 306 ECP	J, M, ML	
72		19	58,5	48	6,2	11 000	12 000	0,38	NUP 306 ECP	J, M, ML	
72		19	58,5	48	6,2	11 000	12 000	0,36	N 306 ECP	–	
72		27	83	75	9,65	11 000	12 000	0,53	NU 2306 ECP	ML	
72		27	83	75	9,65	11 000	12 000	0,54	NJ 2306 ECP	ML	
72		27	83	75	9,65	11 000	12 000	0,55	NUP 2306 ECP	ML	
90		23	60,5	53	6,8	9 000	11 000	0,75	NU 406	–	
90		23	60,5	53	6,8	9 000	11 000	0,77	NJ 406	–	
35		62	14	35,8	38	4,55	12 000	13 000	0,16	NU 1007 ECP	–
	72	17	56	48	6,1	11 000	12 000	0,33	NU 207 ECP	J, M, ML	
	72	17	56	48	6,1	11 000	12 000	0,33	NJ 207 ECP	J, M, ML	
	72	17	56	48	6,1	11 000	12 000	0,31	NUP 207 ECP	J, M, ML	
	72	17	56	48	6,1	11 000	12 000	0,30	N 207 ECP	–	
	72	23	69,5	63	8,15	11 000	12 000	0,40	NU 2207 ECP	J, ML	
	72	23	69,5	63	8,15	11 000	12 000	0,41	NJ 2207 ECP	J, ML	
	72	23	69,5	63	8,15	11 000	12 000	0,42	NUP 2207 ECP	ML	

The designations of SKF Explorer class bearings are printed in blue

¹⁾ When ordering bearings with an alternative standard cage the suffix of the standard cage has to be replaced by the suffix of the cage in question. e.g. NU 305 ECP becomes NU 305 ECML

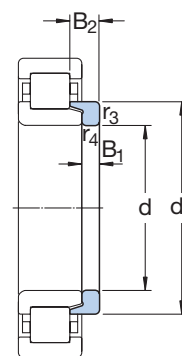
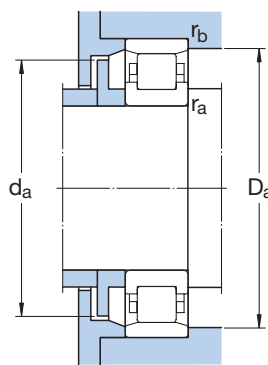
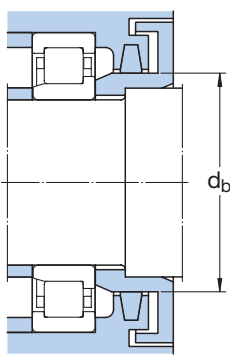
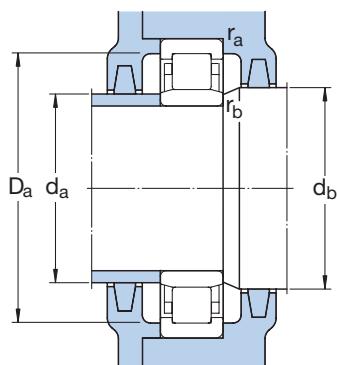

Angle ring

3

Dimensions							Abutment and fillet dimensions						Calculation factor k_r	Angle ring Designation	Mass	Dimensions	
d	d_1	D_1	F, E	$r_{1,2}$ min	$r_{3,4}$ min	$s^1)$	d_a min	d_a max	d_b, D_a min	D_a max	r_a max	r_b max					
mm							mm						-	-	kg	mm	
25 cont.	38,1	50,7	34	1,1	1,1	1,3	32	32	36	55	1	1	0,15	HJ 305 EC	0,023	4	7
	38,1	50,7	34	1,1	1,1	1,3	32	32	40	55	1	1	0,15	HJ 305 EC	0,023	4	7
	38,1	50,7	34	1,1	1,1	-	32	-	40	55	1	1	0,15	-	-	-	-
	38,1	-	54	1,1	1,1	1,3	32	52	56	55	1	1	0,15	-	-	-	-
	38,1	50,7	34	1,1	1,1	2,3	32	32	36	55	1	1	0,25	HJ 2305 EC	0,025	4	8
	38,1	50,7	34	1,1	1,1	2,3	32	32	40	55	1	1	0,25	HJ 2305 EC	0,025	4	8
	38,1	50,7	34	1,1	1,1	-	32	-	40	55	1	1	0,25	-	-	-	-
30	-	45,6	36,5	1	0,6	2,1	33,2	35	38	50,4	1	0,6	0,1	-	-	-	-
	41,2	52,5	37,5	1	0,6	1,3	34,2	36	39	56,4	1	0,6	0,15	HJ 206 EC	0,025	4	7
	41,2	52,5	37,5	1	0,6	1,3	35,6	36	43	56,4	1	0,6	0,15	HJ 206 EC	0,025	4	7
	41,2	52,5	37,5	1	0,6	-	35,6	-	43	56,4	1	0,6	0,15	-	-	-	-
	41,2	-	55,5	1	0,6	1,3	35,6	54	57	57,8	1	0,6	0,15	-	-	-	-
	-	52,5	37,5	1	0,6	1,8	34	36	39	57	1	0,6	0,2	-	-	-	-
	41,2	52,5	37,5	1	0,6	1,8	34	36	43	57	1	0,6	0,2	-	-	-	-
	41,2	52,5	37,5	1	0,6	-	34	-	43	57	1	0,6	0,2	-	-	-	-
	-	58,9	40,5	1,1	1,1	1,4	37	39	42	65	1	1	0,15	-	-	-	-
	45	58,9	40,5	1,1	1,1	1,4	37	39	47	65	1	1	0,15	-	-	-	-
	45	58,9	40,5	1,1	1,1	-	37	-	47	65	1	1	0,15	-	-	-	-
	45	-	62,5	1,1	1,1	1,4	37	60	64	65	1	1	0,15	-	-	-	-
	-	58,9	40,5	1,1	1,1	2,4	37	39	42	65	1	1	0,25	-	-	-	-
	45	58,9	40,5	1,1	1,1	2,4	37	39	47	65	1	1	0,25	-	-	-	-
	45	58,9	40,5	1,1	1,1	-	37	-	47	65	1	1	0,25	-	-	-	-
		50,5	66,6	45	1,5	1,5	1,6	41	43	47	79	1,5	1,5	0,15	HJ 406	0,080	7
	50,5	66,6	45	1,5	1,5	1,6	41	43	47	79	1,5	1,5	0,15	HJ 406	0,080	7	11,5
35	-	54,5	42	1	0,6	1	38,2	41	44	56	1	0,6	0,1	-	-	-	-
	48,1	60,7	44	1,1	0,6	1,3	39,2	42	46	65	1	0,6	0,15	HJ 207 EC	0,033	4	7
	48,1	60,7	44	1,1	0,6	1,3	42	42	50	65	1	0,6	0,15	HJ 207 EC	0,033	4	7
	48,1	60,7	44	1,1	0,6	-	42	-	50	65	1	0,6	0,15	-	-	-	-
	48,1	-	64	1,1	0,6	1,3	42	62	66	67,8	1	0,6	0,15	-	-	-	-
	-	60,7	44	1,1	0,6	2,8	39,2	42	46	65	1	0,6	0,2	-	-	-	-
	48,1	60,7	44	1,1	0,6	2,8	42	42	50	65	1	0,6	0,2	-	-	-	-
	48,1	60,7	44	1,1	0,6	-	42	-	48	65	1	0,6	0,2	-	-	-	-

¹⁾ Permissible axial displacement from normal position of one ring in relation to the other

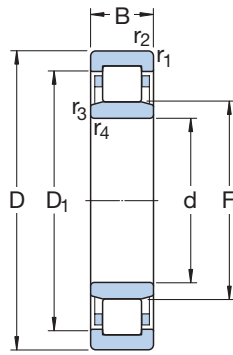

Type NU

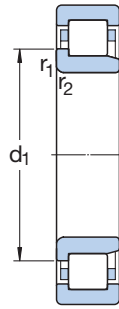

Type NJ

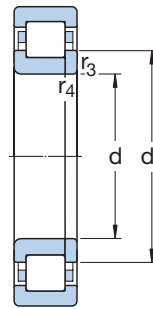

Type NUP

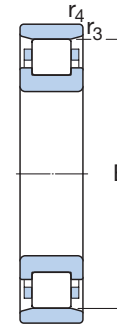

Type N

Principal dimensions			Basic load ratings		Fatigue load limit P _u	Speed ratings		Mass Bearing with standard cage	Designations Bearing with standard cage	Alternative standard cage designs ¹⁾
d	D	B	C	C ₀		Reference speed	Limiting speed			
mm			kN		kN	r/min		kg	–	
35 cont.	80	21	75	63	8,15	9 500	11 000	0,54	NU 307 ECP	J, M, ML
	80	21	75	63	8,15	9 500	11 000	0,55	NJ 307 ECP	J, M, ML
	80	21	75	63	8,15	9 500	11 000	0,51	NUP 307 ECP	J, M, ML
	80	21	75	63	8,15	9 500	11 000	0,48	N 307 ECP	–
	80	31	106	98	12,7	9 500	11 000	0,72	NU 2307 ECP	J
	80	31	106	98	12,7	9 500	11 000	0,73	NJ 2307 ECP	–
	80	31	106	98	12,7	9 500	11 000	0,75	NUP 2307 ECP	–
	100	25	76,5	69,5	9	8 000	9 500	1,00	NU 407	–
100	25	76,5	69,5	9	8 000	9 500	1,05	NJ 407	–	
40	68	15	25,1	26	3	11 000	18 000	0,22	NU 1008 ML	–
	80	18	62	53	6,7	9 500	11 000	0,42	NU 208 ECP	J, M, ML
	80	18	62	53	6,7	9 500	11 000	0,43	NJ 208 ECP	J, M, ML
	80	18	62	53	6,7	9 500	11 000	0,40	NUP 208 ECP	J, M, ML
	80	18	62	53	6,7	9 500	11 000	0,37	N 208 ECP	–
	80	23	81,5	75	9,65	9 500	11 000	0,54	NU 2208 ECP	J, ML
	80	23	81,5	75	9,65	9 500	11 000	0,55	NJ 2208 ECP	J, ML
	80	23	81,5	75	9,65	9 500	11 000	0,56	NUP 2208 ECP	J, ML
	90	23	93	78	10,2	8 000	9 500	0,73	NU 308 ECP	J, M, ML
	90	23	93	78	10,2	8 000	9 500	0,75	NJ 308 ECP	J, M, ML
	90	23	93	78	10,2	8 000	9 500	0,68	NUP 308 ECP	M, ML
	90	23	93	78	10,2	8 000	9 500	0,64	N 308 ECP	–
	90	33	129	120	15,3	8 000	9 500	0,94	NU 2308 ECP	J, M, ML
	90	33	129	120	15,3	8 000	9 500	0,96	NJ 2308 ECP	J, M, ML
	90	33	129	120	15,3	8 000	9 500	0,98	NUP 2308 ECP	M, ML
	110	27	96,8	90	11,6	7 000	8 500	1,40	NU 408	–
	110	27	96,8	90	11,6	7 000	8 500	1,35	NJ 408	–
	45	75	16	44,6	52	6,3	9 500	11 000	0,26	NU 1009 ECP
85		19	69,5	64	8,15	9 000	9 500	0,48	NU 209 ECP	J, M, ML
85		19	69,5	64	8,15	9 000	9 500	0,49	NJ 209 ECP	J, M, ML
85		19	69,5	64	8,15	9 000	9 500	0,45	NUP 209 ECP	J, M, ML
85		19	69,5	64	8,15	9 000	9 500	0,43	N 209 ECP	–
85		23	85	81,5	10,6	9 000	9 500	0,52	NU 2209 ECP	J
85		23	85	81,5	10,6	9 000	9 500	0,54	NJ 2209 ECP	J
85		23	85	81,5	10,6	9 000	9 500	0,55	NUP 2209 ECP	–

The designations of SKF Explorer class bearings are printed in blue

¹⁾ When ordering bearings with an alternative standard cage the suffix of the standard cage has to be replaced by the suffix of the cage in question. e.g. NU 307 ECP becomes NU 307 ECML

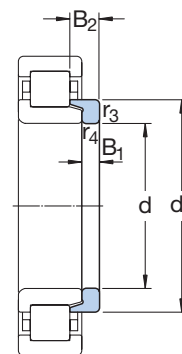
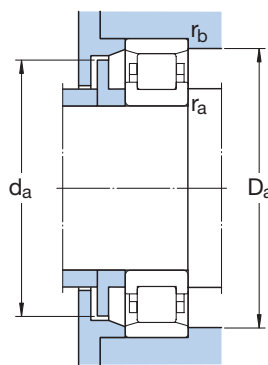
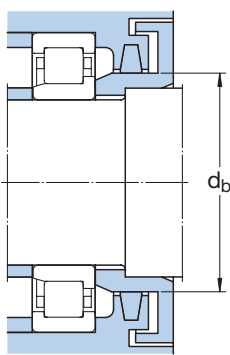
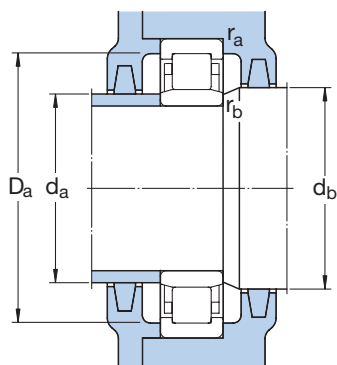

Angle ring

3

Dimensions							Abutment and fillet dimensions						Calculation factor k_r	Angle ring Designation	Mass	Dimensions	
d	d ₁	D ₁	F, E	r _{1,2} min	r _{3,4} min	s ¹⁾	d _a min	d _a max	d _b , D _a min	D _a max	r _a max	r _b max				B ₁	B ₂
mm							mm						-	-	kg	mm	
35 cont.	51	66,3	46,2	1,5	1,1	1,2	42	44	48	71	1,5	1	0,15	HJ 307 EC	0,058	6	9,5
	51	66,3	46,2	1,5	1,1	1,2	44	44	53	71	1,5	1	0,15	HJ 307 EC	0,058	6	9,5
	51	66,3	46,2	1,5	1,1	-	44	-	53	71	1,5	1	0,15	-	-	-	-
	51	-	70,2	1,5	1,1	1,2	44	68	72	73	1,5	1	0,15	-	-	-	-
	-	66,3	46,2	1,5	1,1	2,7	42	44	48	71	1,5	1	0,25	-	-	-	-
	51	66,3	46,2	1,5	1,1	2,7	44	44	53	71	1,5	1	0,25	-	-	-	-
	51	66,3	46,2	1,5	1,1	-	44	-	53	71	1,5	1	0,25	-	-	-	-
	-	76,1	53	1,5	1,5	1,7	46	50	55	89	1,5	1,5	0,15	-	-	-	-
	59	76,1	53	1,5	1,5	1,7	46	50	61	89	1,5	1,5	0,15	-	-	-	-
	40	-	57,6	47	1	0,6	2,4	43,2	45	49	63,4	1	0,6	0,1	-	-	-
54		67,9	49,5	1,1	1,1	1,4	47	48	51	73	1	1	0,15	HJ 208 EC	0,047	5	8,5
54		67,9	49,5	1,1	1,1	1,4	47	48	56	73	1	1	0,15	HJ 208 EC	0,047	5	8,5
54		67,9	49,5	1,1	1,1	-	47	-	56	73	1	1	0,15	-	-	-	-
54		-	71,5	1,1	1,1	1,4	47	69	73	73	1	1	0,15	-	-	-	-
54		67,9	49,5	1,1	1,1	1,9	47	48	51	73	1	1	0,2	HJ 2208 EC	0,048	5	9
54		67,9	49,5	1,1	1,1	1,9	47	48	56	73	1	1	0,2	HJ 2208 EC	0,048	5	9
54		67,9	49,5	1,1	1,1	-	47	-	56	73	1	1	0,2	-	-	-	-
57,5		75,6	52	1,5	1,5	1,4	49	50	54	81	1,5	1,5	0,15	HJ 308 EC	0,084	7	11
57,5		75,6	52	1,5	1,5	1,4	49	50	60	81	1,5	1,5	0,15	HJ 308 EC	0,084	7	11
57,5		75,6	52	1,5	1,5	-	49	-	60	81	1,5	1,5	0,15	-	-	-	-
57,5		-	80	1,5	1,5	1,4	49	78	82	81	1,5	1,5	0,15	-	-	-	-
-		75,6	52	1,5	1,5	2,9	49	50	54	81	1,5	1,5	0,25	-	-	-	-
57,5		75,6	52	1,5	1,5	2,9	49	50	60	81	1,5	1,5	0,25	-	-	-	-
57,5		75,6	52	1,5	1,5	-	49	-	60	81	1,5	1,5	0,25	-	-	-	-
-		84,2	58	2	2	2,5	53	56	60	97	2	2	0,15	-	-	-	-
64,8		84,2	58	2	2	2,5	53	56	67	97	2	2	0,15	-	-	-	-
45		-	65,3	52,5	1	0,6	0,9	48,2	51	54	70,4	1	0,6	0,1	-	-	-
	59	73	54,5	1,1	1,1	1,2	52	53	56	78	1	1	0,15	HJ 209 EC	0,052	5	8,5
	59	73	54,5	1,1	1,1	1,2	52	53	61	78	1	1	0,15	HJ 209 EC	0,052	5	8,5
	59	73	54,5	1,1	1,1	-	52	-	61	78	1	1	0,15	-	-	-	-
	59	-	76,5	1,1	1,1	1,2	52	74	78	78	1	1	0,15	-	-	-	-
	-	73	54,5	1,1	1,1	1,7	52	53	56	78	1	1	0,2	-	-	-	-
	59	73	54,5	1,1	1,1	1,7	52	53	56	78	1	1	0,2	-	-	-	-
	59	73	54,5	1,1	1,1	-	52	-	61	78	1	1	0,2	-	-	-	-

¹⁾ Permissible axial displacement from normal position of one ring in relation to the other

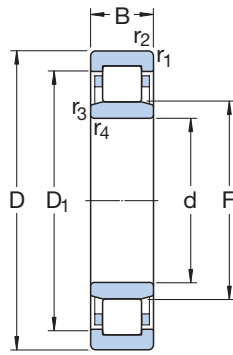

Type NU



Type NJ

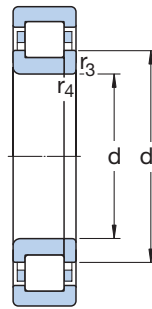

Type NUP

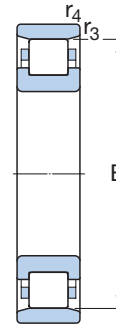

Type N

Principal dimensions			Basic load ratings		Fatigue load limit P _u	Speed ratings		Mass Bearing with standard cage	Designations Bearing with standard cage	Alternative standard cage designs ¹⁾	
d	D	B	C	C ₀		Reference speed	Limiting speed				
mm			kN		kN	r/min		kg	–		
45 cont.	100	25	112	100	12,9	7 500	8 500	1,00	NU 309 ECP	J, M, ML	
	100	25	112	100	12,9	7 500	8 500	1,05	NJ 309 ECP	J, M, ML	
	100	25	112	100	12,9	7 500	8 500	0,95	NUP 309 ECP	J, ML	
	100	25	112	100	12,9	7 500	8 500	0,88	N 309 ECP	–	
	100	36	160	153	20	7 500	8 500	1,30	NU 2309 ECP	ML	
	100	36	160	153	20	7 500	8 500	1,35	NJ 2309 ECP	ML	
	100	36	160	153	20	7 500	8 500	1,35	NUP 2309 ECP	ML	
	120	29	106	102	13,4	6 700	7 500	1,78	NU 409	–	
	120	29	106	102	13,4	6 700	7 500	1,70	NJ 409	–	
	50	80	16	46,8	56	6,7	9 000	9 500	0,27	NU 1010 ECP	–
		90	20	73,5	69,5	8,8	8 500	9 000	0,49	NU 210 ECP	J, M, ML
		90	20	73,5	69,5	8,8	8 500	9 000	0,50	NJ 210 ECP	J, M, ML
90		20	73,5	69,5	8,8	8 500	9 000	0,51	NUP 210 ECP	J, ML	
90		20	73,5	69,5	8,8	8 500	9 000	0,48	N 210 ECP	–	
90		23	90	88	11,4	8 500	9 000	0,56	NU 2210 ECP	J, M, ML	
90		23	90	88	11,4	8 500	9 000	0,59	NJ 2210 ECP	J, M, ML	
90		23	90	88	11,4	8 500	9 000	0,59	NUP 2210 ECP	J, ML	
110		27	127	112	15	6 700	8 000	1,15	NU 310 ECP	J, M, ML	
110		27	127	112	15	6 700	8 000	1,15	NJ 310 ECP	J, M, ML	
110		27	127	112	15	6 700	8 000	1,20	NUP 310 ECP	J, M, ML	
110		27	127	112	15	6 700	8 000	1,15	N 310 ECP	M	
110		40	186	186	24,5	6 700	8 000	2,00	NU 2310 ECP	ML	
110		40	186	186	24,5	6 700	8 000	1,75	NJ 2310 ECP	ML	
110		40	186	186	24,5	6 700	8 000	1,80	NUP 2310 ECP	ML	
130		31	130	127	16,6	6 000	7 000	2,00	NU 410	–	
130		31	130	127	16,6	6 000	7 000	2,05	NJ 410	–	
55		90	18	57,2	69,5	8,3	8 000	8 500	0,40	NU 1011 ECP	–
		100	21	96,5	95	12,2	7 500	8 000	0,67	NU 211 ECP	J, M, ML
		100	21	96,5	95	12,2	7 500	8 000	0,67	NJ 211 ECP	J, M, ML
		100	21	96,5	95	12,2	7 500	8 000	0,69	NUP 211 ECP	J, M, ML
	100	21	96,5	95	12,2	7 500	8 000	0,66	N 211 ECP	M	
	100	25	114	118	15,3	7 500	8 000	0,79	NU 2211 ECP	J, M, ML	
	100	25	114	118	15,3	7 500	8 000	0,81	NJ 2211 ECP	J, M, ML	
	100	25	114	118	15,3	7 500	8 000	0,82	NUP 2211 ECP	J, ML	

The designations of SKF Explorer class bearings are printed in blue

¹⁾ When ordering bearings with an alternative standard cage the suffix of the standard cage has to be replaced by the suffix of the cage in question. e.g. NU 309 ECP becomes NU 309 ECML.

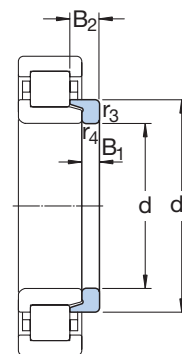
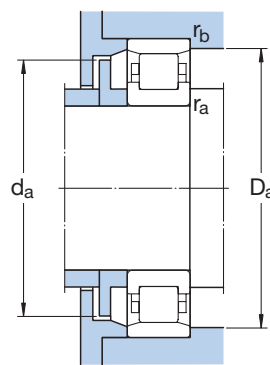
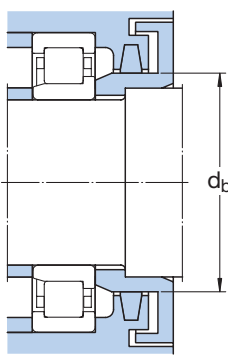
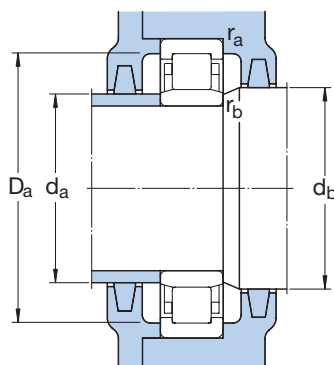

Angle ring

3

Dimensions							Abutment and fillet dimensions						Calculation factor k_r	Angle ring Designation	Mass	Dimensions	
d	d_1	D_1	F, E	$r_{1,2}$ min	$r_{3,4}$ min	$s^1)$	d_a min	d_a max	d_b, D_a min	D_a max	r_a max	r_b max				B ₁	B ₂
mm							mm						-	-	kg	mm	
45 cont.	64,4	83,8	58,5	1,5	1,5	1,7	54	56	61	91	1,5	1,5	0,15	HJ 309 EC	0,11	7	11,5
	64,4	83,8	58,5	1,5	1,5	1,7	54	56	67	91	1,5	1,5	0,15	HJ 309 EC	0,11	7	11,5
	64,4	83,8	58,5	1,5	1,5	-	54	-	67	91	1,5	1,5	0,15	-	-	-	-
	64,4	-	88,5	1,5	1,5	1,7	54	86	91	91	1,5	1,5	0,15	-	-	-	-
	-	83,8	58,5	1,5	1,5	3,2	54	56	61	91	1,5	1,5	0,25	-	-	-	-
	64,4	83,8	58,5	1,5	1,5	3,2	54	56	67	91	1,5	1,5	0,25	-	-	-	-
	64,4	83,8	58,5	1,5	1,5	-	54	-	67	91	1,5	1,5	0,25	-	-	-	-
	71,8	92,2	64,5	2	2	2,5	58	62	67	107	2	2	0,15	HJ 409	0,18	8	13,5
	71,8	92,2	64,5	2	2	2,5	58	62	74	107	2	2	0,15	HJ 409	0,18	8	13,5
	50	-	70	57,5	1	0,6	1	53,2	56	60	75,4	1	0,6	0,1	-	-	-
64		78	59,5	1,1	1,1	1,5	57	57	62	83	1	1	0,15	HJ 210 EC	0,058	5	9
64		78	59,5	1,1	1,1	1,5	57	57	66	83	1	1	0,15	HJ 210 EC	0,058	5	9
64		78	59,5	1,1	1,1	-	57	-	66	83	1	1	0,15	-	-	-	-
64		-	81,5	1,1	1,1	1,5	57	79	83	83	1	1	0,15	-	-	-	-
-		78	59,5	1,1	1,1	1,5	57	57	62	83	1	1	0,2	-	-	-	-
64		78	59,5	1,1	1,1	1,5	57	57	66	83	1	1	0,2	-	-	-	-
64		78	59,5	1,1	1,1	-	57	-	66	83	1	1	0,2	-	-	-	-
71,2		92,1	65	2	2	1,9	61	63	67	99	2	2	0,15	HJ 310 EC	0,14	8	13
71,2		92,1	65	2	2	1,9	61	63	73	99	2	2	0,15	HJ 310 EC	0,14	8	13
71,2		92,1	65	2	2	-	61	-	73	99	2	2	0,15	-	-	-	-
71,2		-	97	2	2	1,9	61	95	99	99	2	2	0,15	-	-	-	-
-		92,1	65	2	2	3,4	61	63	67	99	2	2	0,25	-	-	-	-
71,2		92,1	65	2	2	3,4	61	63	73	99	2	2	0,25	-	-	-	-
71,2		92,1	65	2	2	-	61	-	73	99	2	2	0,25	-	-	-	-
-		102	70,8	2,1	2,1	2,6	64	68	73	116	2	2	0,15	-	-	-	-
78,8	102	70,8	2,1	2,1	2,6	64	68	81	116	2	2	0,15	-	-	-	-	
55	-	79	64,5	1,1	1	0,5	59,6	63	67	84	1	1	0,1	-	-	-	-
	70,8	86,3	66	1,5	1,1	1	62	64	68	91	1,5	1	0,15	HJ 211 EC	0,083	6	9,5
	70,8	86,3	66	1,5	1,1	1	64	64	73	91	1,5	1	0,15	HJ 211 EC	0,083	6	9,5
	70,8	86,3	66	1,5	1,1	-	64	-	73	91	1,5	1	0,15	-	-	-	-
	70,8	-	90	1,5	1,1	1	64	88	92	93	1,5	1	0,15	-	-	-	-
	70,8	86,3	66	1,5	1,1	1,5	62	64	68	91	1,5	1	0,2	HJ 2211 EC	0,085	6	10
	70,8	86,3	66	1,5	1,1	1,5	64	64	73	91	1,5	1	0,2	HJ 2211 EC	0,085	6	10
	70,8	86,3	66	1,5	1,1	-	64	-	73	91	1,5	1	0,2	-	-	-	-

¹⁾ Permissible axial displacement from normal position of one ring in relation to the other

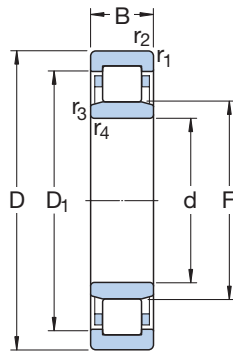

Type NU



Type NJ

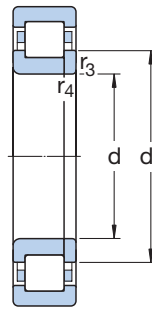

Type NUP



Type N

Principal dimensions			Basic load ratings		Fatigue load limit P _u	Speed ratings		Mass Bearing with standard cage	Designations Bearing with standard cage	Alternative standard cage designs ¹⁾	
d	D	B	C	C ₀		Reference speed	Limiting speed				
mm			kN		kN	r/min		kg	–		
55 cont.	120	29	156	143	18,6	6 000	7 000	1,45	NU 311 ECP	J, M, ML	
	120	29	156	143	18,6	6 000	7 000	1,50	NJ 311 ECP	J, M, ML	
	120	29	156	143	18,6	6 000	7 000	1,55	NUP 311 ECP	J, M, ML	
	120	29	156	143	18,6	6 000	7 000	1,45	N 311 ECP	M	
	120	43	232	232	30,5	6 000	7 000	2,25	NU 2311 ECP	ML	
	120	43	232	232	30,5	6 000	7 000	2,30	NJ 2311 ECP	ML	
	120	43	232	232	30,5	6 000	7 000	2,35	NUP 2311 ECP	ML	
	140	33	142	140	18,6	5 600	6 300	2,50	NU 411	–	
140	33	142	140	18,6	5 600	6 300	2,55	NJ 411	–		
60	95	18	37,4	44	5,3	8 000	11 000	0,48	NU 1012 ML	–	
	110	22	108	102	13,4	6 700	7 500	0,81	NU 212 ECP	J, M, ML	
	110	22	108	102	13,4	6 700	7 500	0,83	NJ 212 ECP	J, M, ML	
	110	22	108	102	13,4	6 700	7 500	0,86	NUP 212 ECP	J, ML	
	110	22	108	102	13,4	6 700	7 500	0,81	N 212 ECP	M	
	110	28	146	153	20	6 700	7 500	1,10	NU 2212 ECP	J, M, ML	
	110	28	146	153	20	6 700	7 500	1,15	NJ 2212 ECP	J, M, ML	
	110	28	146	153	20	6 700	7 500	1,15	NUP 2212 ECP	J, ML	
	130	31	173	160	20,8	5 600	6 700	1,80	NU 312 ECP	J, M, ML	
	130	31	173	160	20,8	5 600	6 700	1,90	NJ 312 ECP	J, M, ML	
	130	31	173	160	20,8	5 600	6 700	1,95	NUP 312 ECP	J, M, ML	
	130	31	173	160	20,8	5 600	6 700	1,80	N 312 ECP	M	
	130	46	260	265	34,5	5 600	6 700	2,75	NU 2312 ECP	ML	
	130	46	260	265	34,5	5 600	6 700	2,80	NJ 2312 ECP	ML	
	130	46	260	265	34,5	5 600	6 700	2,85	NUP 2312 ECP	ML	
	150	35	168	173	22	5 000	6 000	3,00	NU 412	–	
	150	35	168	173	22	5 000	6 000	3,10	NJ 412	–	
	65	100	18	62,7	81,5	9,8	7 000	7 500	0,45	NU 1013 ECP	–
		120	23	122	118	15,6	6 300	6 700	1,05	NU 213 ECP	J, M, ML
		120	23	122	118	15,6	6 300	6 700	1,07	NJ 213 ECP	J, M, ML
120		23	122	118	15,6	6 300	6 700	1,10	NUP 213 ECP	J, ML	
120		23	122	118	15,6	6 300	6 700	1,05	N 213 ECP	–	
120		31	170	180	24	6 300	6 700	1,40	NU 2213 ECP	J	
120		31	170	180	24	6 300	6 700	1,45	NJ 2213 ECP	J	
120		31	170	180	24	6 300	6 700	1,50	NUP 2213 ECP	–	

The designations of SKF Explorer class bearings are printed in blue

¹⁾ When ordering bearings with an alternative standard cage the suffix of the standard cage has to be replaced by the suffix of the cage in question. e.g. NU 311 ECP becomes NU 311 ECML

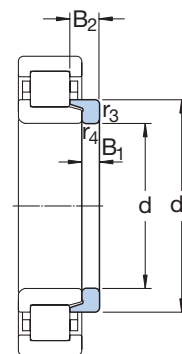
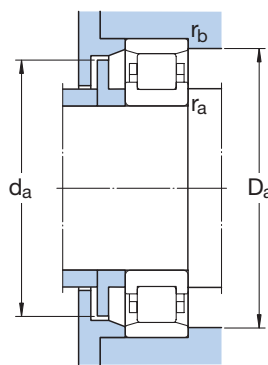
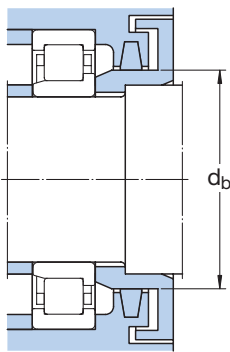
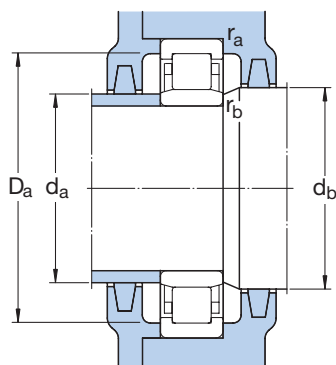

Angle ring

3

Dimensions							Abutment and fillet dimensions						Calculation factor k_r	Angle ring Designation	Mass	Dimensions	
d	d_1	D_1	F, E	$r_{1,2}$ min	$r_{3,4}$ min	$s^1)$	d_a min	d_a max	d_b, D_a min	D_a max	r_a max	r_b max				B ₁	B ₂
mm							mm						-	-	kg	mm	
55 cont.	77,5	101	70,5	2	2	2	66	68	73	109	2	2	0,15	HJ 311 EC	0,19	9	14
	77,5	101	70,5	2	2	2	66	68	80	109	2	2	0,15	HJ 311 EC	0,19	9	14
	77,5	101	70,5	2	2	-	66	-	80	109	2	2	0,15	-	-	-	-
	77,5	-	106,5	2	2	2	66	104	109	109	2	2	0,15	-	-	-	-
	77,5	101	70,5	2	2	3,5	66	68	73	109	2	2	0,25	HJ 2311 EC	0,19	9	15,5
	77,5	101	70,5	2	2	3,5	66	68	80	109	2	2	0,25	HJ 2311 EC	0,19	9	15,5
	77,5	101	70,5	2	2	-	66	-	80	109	2	2	0,25	-	-	-	-
	85,2	108	77,2	2,1	2,1	2,6	69	74	79	126	2	2	0,15	-	-	-	-
	85,2	108	77,2	2,1	2,1	2,6	69	74	88	126	2	2	0,15	-	-	-	-
	60	-	81,6	69,5	1,1	1	2,9	64,6	68	72	89	1	1	0,1	-	-	-
77,5		95,7	72	1,5	1,5	1,4	69	70	74	101	1,5	1,5	0,15	HJ 212 EC	0,10	6	10
77,5		95,7	72	1,5	1,5	1,4	69	70	80	101	1,5	1,5	0,15	HJ 212 EC	0,10	6	10
77,5		95,7	72	1,5	1,5	-	69	-	80	101	1,5	1,5	0,15	-	-	-	-
77,5		-	100	1,5	1,5	1,4	69	98	101	101	1,5	1,5	0,15	-	-	-	-
77,5		95,7	72	1,5	1,5	1,4	69	70	74	101	1,5	1,5	0,2	HJ 212 EC	0,10	6	10
77,5		95,7	72	1,5	1,5	1,4	69	70	80	101	1,5	1,5	0,2	HJ 212 EC	0,10	6	10
77,5		95,7	72	1,5	1,5	-	69	-	80	101	1,5	1,5	0,2	-	-	-	-
84,3		110	77	2,1	2,1	2,1	72	74	79	118	2	2	0,15	HJ 312 EC	0,22	9	14,5
84,3		110	77	2,1	2,1	2,1	72	74	87	118	2	2	0,15	HJ 312 EC	0,22	9	14,5
84,3		110	77	2,1	2,1	-	72	-	87	118	2	2	0,15	-	-	-	-
84,3		-	115	2,1	2,1	2,1	72	112	118	118	2	2	0,15	-	-	-	-
-		110	77	2,1	2,1	3,6	72	74	79	118	2	2	0,25	-	-	-	-
84,3		110	77	2,1	2,1	3,6	72	74	87	118	2	2	0,25	-	-	-	-
84,3		110	77	2,1	2,1	-	72	-	87	118	2	2	0,25	-	-	-	-
-		117	83	2,1	2,1	2,5	74	80	85	136	2	2	0,15	-	-	-	-
91,8	117	83	2,1	2,1	2,5	74	80	94	136	2	2	0,15	-	-	-	-	
65	-	88,5	74	1,1	1	1	69,6	72	77	94	1	1	0,1	-	-	-	-
	84,4	104	78,5	1,5	1,5	1,4	74	76	81	111	1,5	1,5	0,15	HJ 213 EC	0,12	6	10
	84,4	104	78,5	1,5	1,5	1,4	74	76	87	111	1,5	1,5	0,15	HJ 213 EC	0,12	6	10
	84,4	104	78,5	1,5	1,5	-	74	-	87	111	1,5	1,5	0,15	-	-	-	-
	84,4	-	108,5	1,5	1,5	1,4	74	106	111	111	1,5	1,5	0,15	-	-	-	-
	-	104	78,5	1,5	1,5	1,9	74	76	81	111	1,5	1,5	0,2	-	-	-	-
	84,4	104	78,5	1,5	1,5	1,9	74	76	87	111	1,5	1,5	0,2	-	-	-	-
	84,4	104	78,5	1,5	1,5	-	74	-	87	111	1,5	1,5	0,2	-	-	-	-

¹⁾ Permissible axial displacement from normal position of one ring in relation to the other

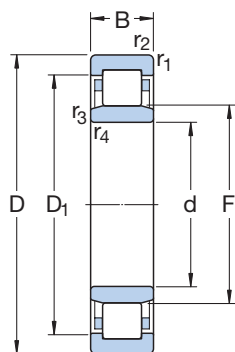

Type NU

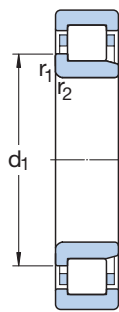

Type NJ

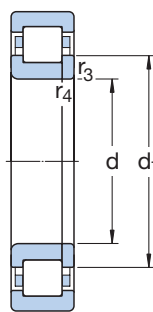

Type NUP

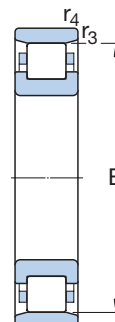

Type N

Principal dimensions			Basic load ratings		Fatigue load limit P_u	Speed ratings		Mass Bearing with standard cage	Designations Bearing with standard cage	Alternative standard cage designs ¹⁾	
d	D	B	C	C_0		Reference speed	Limiting speed				
mm			kN		kN	r/min		kg	–		
65 cont.	140	33	212	196	25,5	5 300	5 600	2,28	NU 313 ECP	J, M, ML	
	140	33	212	196	25,5	5 300	5 600	2,30	NJ 313 ECP	J, M, ML	
	140	33	212	196	25,5	5 300	5 600	2,35	NUP 313 ECP	J, ML	
	140	33	212	196	25,5	5 300	5 600	2,25	N 313 ECP	M	
	140	48	285	290	38	5 300	5 600	3,30	NU 2313 ECP	ML	
	140	48	285	290	38	5 300	5 600	3,35	NJ 2313 ECP	ML	
	140	48	285	290	38	5 300	5 600	3,45	NUP 2313 ECP	ML	
	160	37	183	190	24	4 800	5 600	3,60	NU 413	–	
	160	37	183	190	24	4 800	5 600	3,65	NJ 413	–	
	70	110	20	76,5	93	12	6 300	7 000	0,62	NU 1014 ECP	–
		125	24	137	137	18	6 000	6 300	1,15	NU 214 ECP	J, M, ML
		125	24	137	137	18	6 000	6 300	1,15	NJ 214 ECP	J, M, ML
125		24	137	137	18	6 000	6 300	1,20	NUP 214 ECP	M, ML	
125		24	137	137	18	6 000	6 300	1,15	N 214 ECP	–	
125		31	180	193	25,5	6 000	6 300	1,55	NU 2214 ECP	J, M, ML	
125		31	180	193	25,5	6 000	6 300	1,55	NJ 2214 ECP	M, ML	
125		31	180	193	25,5	6 000	6 300	1,55	NUP 2214 ECP	M, ML	
150		35	236	228	29	4 800	5 600	2,75	NU 314 ECP	J, M, ML	
150		35	236	228	29	4 800	5 600	2,80	NJ 314 ECP	J, M, ML	
150		35	236	228	29	4 800	5 600	2,85	NUP 314 ECP	M, ML	
150		35	236	228	29	4 800	5 600	2,75	N 314 ECP	M	
150		51	315	325	41,5	4 800	5 600	4,00	NU 2314 ECP	ML	
150		51	315	325	41,5	4 800	5 600	4,05	NJ 2314 ECP	ML	
150		51	315	325	41,5	4 800	5 600	4,15	NUP 2314 ECP	ML	
180		42	229	240	30	4 300	5 000	5,25	NU 414	–	
180		42	229	240	30	4 300	5 000	5,35	NJ 414	–	
75		115	20	58,3	71	8,5	6 700	10 000	0,74	NU 1015 ML	–
		130	25	150	156	20,4	5 600	6 000	1,25	NU 215 ECP	J, M, ML
		130	25	150	156	20,4	5 600	6 000	1,30	NJ 215 ECP	J, M, ML
		130	25	150	156	20,4	5 600	6 000	1,30	NUP 215 ECP	M, ML
		130	25	150	156	20,4	5 600	6 000	1,25	N 215 ECP	–
		130	31	186	208	27	5 600	6 000	1,60	NU 2215 ECP	J, ML
		130	31	186	208	27	5 600	6 000	1,60	NJ 2215 ECP	J, ML
	130	31	186	208	27	5 600	6 000	1,65	NUP 2215 ECP	J, ML	

The designations of SKF Explorer class bearings are printed in blue

¹⁾ When ordering bearings with an alternative standard cage the suffix of the standard cage has to be replaced by the suffix of the cage in question. e.g. NU 313 ECP becomes NU 313 ECML

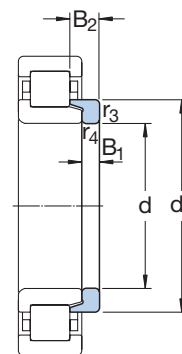
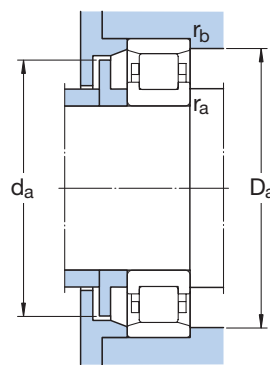
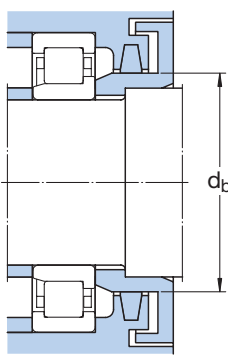
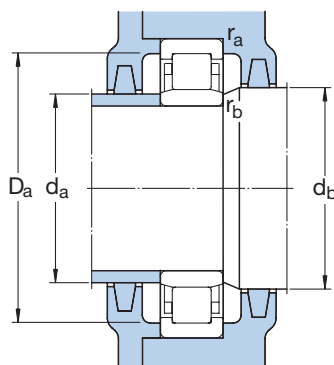

Angle ring

3

Dimensions							Abutment and fillet dimensions						Calculation factor k_r	Angle ring Designation	Mass	Dimensions	
d	d_1	D_1	F, E	$r_{1,2}$ min	$r_{3,4}$ min	$s^1)$	d_a min	d_a max	d_b, D_a min	D_a max	r_a max	r_b max				B_1	B_2
mm							mm						-	-	kg	mm	
65 cont.	90,5	119	82,5	2,1	2,1	2,2	77	80	85	128	2	2	0,15	HJ 313 EC	0,27	10	15,5
	90,5	119	82,5	2,1	2,1	2,2	77	80	93	128	2	2	0,15	HJ 313 EC	0,27	10	15,5
	90,5	119	82,5	2,1	2,1	-	77	-	93	128	2	2	0,15	-	-	-	-
	90,5	-	124,5	2,1	2,1	2,2	77	122	127	128	2	2	0,15	-	-	-	-
	-	119	82,5	2,1	2,1	4,7	77	80	85	128	2	2	0,25	-	-	-	-
	90,5	119	82,5	2,1	2,1	4,7	77	80	93	128	2	2	0,25	-	-	-	-
	90,5	119	82,5	2,1	2,1	-	77	-	93	128	2	2	0,25	-	-	-	-
	98,5	125	89,3	2,1	2,1	2,6	79	86	92	146	2	2	0,15	HJ 413	0,42	11	18
	98,5	125	89,3	2,1	2,1	2,6	79	86	92	146	2	2	0,15	HJ 413	0,42	11	18
	70	84	97,5	79,5	1,1	1	1,3	74,6	78	82	104	1	1	0,1	HJ 1014 EC	0,082	5
89,4		109	83,5	1,5	1,5	1,2	79	81	86	116	1,5	1,5	0,15	HJ 214 EC	0,15	7	11
89,4		109	83,5	1,5	1,5	1,2	79	81	92	116	1,5	1,5	0,15	HJ 214 EC	0,15	7	11
89,4		109	83,5	1,5	1,5	-	79	-	92	116	1,5	1,5	0,15	-	-	-	-
89,4		-	113,5	1,5	1,5	1,2	79	111	116	116	1,5	1,5	0,15	-	-	-	-
-		109	83,5	1,5	1,5	1,7	79	81	86	116	1,5	1,5	0,2	-	-	-	-
89,4		109	83,5	1,5	1,5	1,7	79	81	92	116	1,5	1,5	0,2	-	-	-	-
89,4		109	83,5	1,5	1,5	-	79	-	92	116	1,5	1,5	0,2	-	-	-	-
97,3		127	89	2,1	2,1	1,8	82	86	91	138	2	2	0,15	HJ 314 EC	0,32	10	15,5
97,3		127	89	2,1	2,1	1,8	82	86	100	138	2	2	0,15	HJ 314 EC	0,32	10	15,5
97,3		127	89	2,1	2,1	-	82	-	100	138	2	2	0,15	-	-	-	-
97,3		-	133	2,1	2,1	1,8	82	130	136	138	2	2	0,15	-	-	-	-
97,3		127	89	2,1	2,1	4,8	82	86	91	138	2	2	0,25	HJ 2314 EC	0,34	10	18,5
97,3		127	89	2,1	2,1	4,8	82	86	100	138	2	2	0,25	HJ 2314 EC	0,34	10	18,5
97,3		127	89	2,1	2,1	-	82	-	100	138	2	2	0,25	-	-	-	-
-	140	100	3	3	3,5	86	97	102	164	2,5	2,5	0,15	-	-	-	-	
110	140	100	3	3	3,5	86	97	113	164	2,5	2,5	0,15	-	-	-	-	
75	-	101	85	1,1	1	3	79,6	83	87	109	1	1	0,1	-	-	-	-
	94,3	114	88,5	1,5	1,5	1,2	84	86	91	121	1,5	1,5	0,15	HJ 215 EC	0,16	7	11
	94,3	114	88,5	1,5	1,5	1,2	84	86	97	121	1,5	1,5	0,15	HJ 215 EC	0,16	7	11
	94,3	114	88,5	1,5	1,5	-	84	-	97	121	1,5	1,5	0,15	-	-	-	-
	94,3	-	118,5	1,5	1,5	1,2	84	116	121	121	1,5	1,5	0,15	-	-	-	-
	-	114	88,5	1,5	1,5	1,7	84	86	91	121	1,5	1,5	0,2	-	-	-	-
	94,3	114	88,5	1,5	1,5	1,7	84	86	97	121	1,5	1,5	0,2	-	-	-	-
	94,3	114	88,5	1,5	1,5	-	84	-	97	121	1,5	1,5	0,2	-	-	-	-

¹⁾ Permissible axial displacement from normal position of one ring in relation to the other

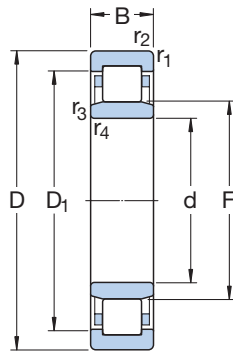

Type NU



Type NJ

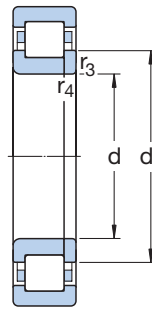

Type NUP



Type N

Principal dimensions			Basic load ratings		Fatigue load limit P _u	Speed ratings		Mass Bearing with standard cage	Designations Bearing with standard cage	Alternative standard cage designs ¹⁾
d	D	B	C	C ₀		Reference speed	Limiting speed			
mm			kN		kN	r/min		kg	–	
75 cont.	160	37	280	265	33,5	4 500	5 300	3,30	NU 315 ECP	J, M, ML
	160	37	280	265	33,5	4 500	5 300	3,35	NJ 315 ECP	J, M, ML
	160	37	280	265	33,5	4 500	5 300	3,45	NUP 315 ECP	M, ML
	160	37	280	265	33,5	4 500	5 300	3,30	N 315 ECP	M
	160	55	380	400	50	4 500	5 300	4,90	NU 2315 ECP	J, ML
	160	55	380	400	50	4 500	5 300	5,00	NJ 2315 ECP	ML
	160	55	380	400	50	4 500	5 300	5,10	NUP 2315 ECP	ML
	190	45	264	280	34	4 000	4 800	6,75	NU 415	–
	190	45	264	280	34	4 000	4 800	6,90	NJ 415	–
80	125	22	66	81,5	10,4	6 300	6 300	1,00	NU 1016	–
	125	22	99	127	16,3	5 600	9 500	1,10	NJ 1016 ECML	–
	140	26	160	166	21,2	5 300	5 600	1,50	NU 216 ECP	J, M, ML
	140	26	160	166	21,2	5 300	5 600	1,60	NJ 216 ECP	J, M, ML
	140	26	160	166	21,2	5 300	5 600	1,65	NUP 216 ECP	ML
	140	26	160	166	21,2	5 300	5 600	1,50	N 216 ECP	–
	140	33	212	245	31	5 300	5 600	2,00	NU 2216 ECP	J, M, ML
	140	33	212	245	31	5 300	5 600	2,05	NJ 2216 ECP	J, M, ML
	140	33	212	245	31	5 300	5 600	2,10	NUP 2216 ECP	M, ML
	170	39	300	290	36	4 300	5 000	3,95	NU 316 ECP	J, M, ML
	170	39	300	290	36	4 300	5 000	4,00	NJ 316 ECP	J, M, ML
	170	39	300	290	36	4 300	5 000	4,10	NUP 316 ECP	M, ML
	170	39	300	290	36	4 300	5 000	3,90	N 316 ECP	M
	170	58	415	440	55	4 300	5 000	5,95	NU 2316 ECP	M, ML
	170	58	415	440	55	4 300	5 000	6,00	NJ 2316 ECP	M, ML
	170	58	415	440	55	4 300	5 000	6,00	NUP 2316 ECP	M, ML
	200	48	303	320	39	3 800	4 500	7,30	NU 416	–
	200	48	303	320	39	3 800	4 500	8,05	NJ 416	–
85	130	22	68,2	86,5	10,8	6 000	9 000	1,05	NU 1017 ML	–
	150	28	190	200	24,5	4 800	5 300	1,90	NU 217 ECP	J, M, ML
	150	28	190	200	24,5	4 800	5 300	1,95	NJ 217 ECP	J, M, ML
	150	28	190	200	24,5	4 800	5 300	2,00	NUP 217 ECP	J, ML
	150	28	190	200	24,5	4 800	5 300	1,90	N 217 ECP	M
	150	36	250	280	34,5	4 800	5 300	2,45	NU 2217 ECP	J, M, ML
	150	36	250	280	34,5	4 800	5 300	2,55	NJ 2217 ECP	J, M, ML
	150	36	250	280	34,5	4 800	5 300	2,65	NUP 2217 ECP	ML

The designations of SKF Explorer class bearings are printed in blue

¹⁾ When ordering bearings with an alternative standard cage the suffix of the standard cage has to be replaced by the suffix of the cage in question. e.g. NU 315 ECP becomes NU 315 ECML

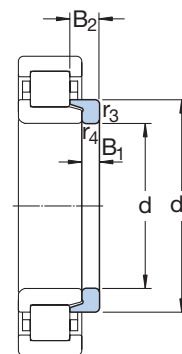
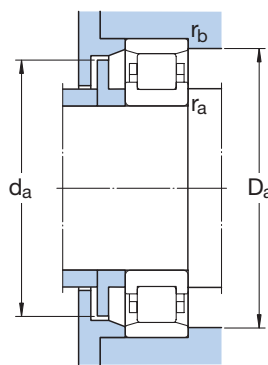
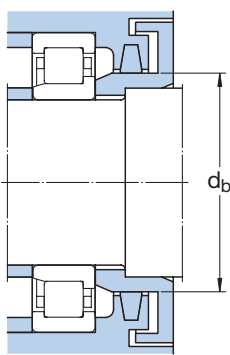
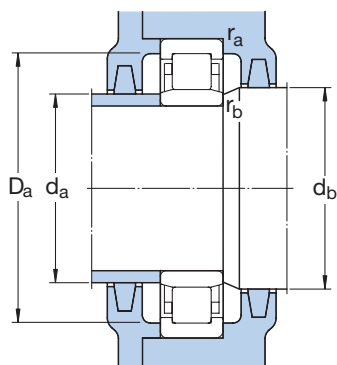

Angle ring

3

Dimensions							Abutment and fillet dimensions						Calculation factor k_r	Angle ring Designation	Mass	Dimensions		
d	d_1	D_1	F, E	$r_{1,2}$ min	$r_{3,4}$ min	$s^{1)}$	d_a min	d_a max	d_b, D_a min	D_a max	r_a max	r_b max				B_1	B_2	
mm							mm						-	-	kg	mm		
75 cont.	104	136	95	2,1	2,1	1,8	87	92	97	148	2	2	0,15	HJ 315 EC	0,39	11	16,5	
	104	136	95	2,1	2,1	1,8	87	92	107	148	2	2	0,15	HJ 315 EC	0,39	11	16,5	
	104	136	95	2,1	2,1	-	87	-	107	148	2	2	0,15	-	-	-	-	
	104	-	143	2,1	2,1	1,8	87	140	146	148	2	2	0,15	-	-	-	-	
	104	136	95	2,1	2,1	4,8	87	92	97	148	2	2	0,25	HJ 2315 EC	0,42	11	19,5	
	104	136	95	2,1	2,1	4,8	87	92	107	148	2	2	0,25	HJ 2315 EC	0,42	11	19,5	
	104	136	95	2,1	2,1	-	87	-	107	148	2	2	0,25	-	-	-	-	
	-	148	104,5	3	3	3,8	91	101	107	174	2,5	2,5	0,15	-	-	-	-	
	116	148	104,5	3	3	3,8	91	101	119	174	2,5	2,5	0,15	-	-	-	-	
	80	-	109	91,5	1,1	1	3,3	86	90	94	119	1	1	0,1	-	-	-	-
		96,2	111	91,5	1,1	1	1,5	86	90	94	119	1	1	0,1	-	-	-	-
		101	123	95,3	2	2	1,4	91	93	98	129	2	2	0,15	HJ 216 EC	0,21	8	12,5
101		123	95,3	2	2	1,4	91	93	104	129	2	2	0,15	HJ 216 EC	0,21	8	12,5	
101		123	95,3	2	2	-	91	-	104	129	2	2	0,15	-	-	-	-	
101		-	127,3	2	2	1,4	91	125	129	129	2	2	0,15	-	-	-	-	
101		123	95,3	2	2	1,4	91	93	98	129	2	2	0,2	HJ 216 EC	0,21	8	12,5	
101		123	95,3	2	2	1,4	91	93	104	129	2	2	0,2	HJ 216 EC	0,21	8	12,5	
101		123	95,3	2	2	-	91	-	104	129	2	2	0,2	-	-	-	-	
110		144	101	2,1	2,1	2,1	92	98	104	158	2	2	0,15	HJ 316 EC	0,44	11	17	
110		144	101	2,1	2,1	2,1	92	98	113	158	2	2	0,15	HJ 316 EC	0,44	11	17	
110		144	101	2,1	2,1	-	92	-	113	158	2	2	0,15	-	-	-	-	
110		-	151	2,1	2,1	2,1	92	148	154	158	2	2	0,15	-	-	-	-	
110		144	101	2,1	2,1	5,1	92	98	104	158	2	2	0,25	HJ 2316 EC	0,48	11	20	
110		144	101	2,1	2,1	5,1	92	98	113	158	2	2	0,25	HJ 2316 EC	0,48	11	20	
110		144	101	2,1	2,1	-	92	-	113	158	2	2	0,25	-	-	-	-	
122		157	110	3	3	3,7	96	106	113	184	2,5	2,5	0,15	HJ 416	0,78	13	22	
122		157	110	3	3	3,7	96	106	125	184	2,5	2,5	0,15	HJ 416	0,78	13	22	
85	-	114	96,5	1,1	1	3,3	89,6	95	99	124	1	1	0,1	-	-	-	-	
	107	131	100,5	2	2	1,5	96	98	103	139	2	2	0,15	HJ 217 EC	0,24	8	12,5	
	107	131	100,5	2	2	1,5	96	98	110	139	2	2	0,15	HJ 217 EC	0,24	8	12,5	
	107	131	100,5	2	2	-	96	-	110	139	2	2	0,15	-	-	-	-	
	107	-	136,5	2	2	1,5	96	134	139	139	2	2	0,15	-	-	-	-	
	-	131	100,5	2	2	2	96	98	103	139	2	2	0,2	-	-	-	-	
	107	131	100,5	2	2	2	96	98	110	139	2	2	0,2	-	-	-	-	
	107	131	100,5	2	2	-	96	-	110	139	2	2	0,2	-	-	-	-	

¹⁾ Permissible axial displacement from normal position of one ring in relation to the other

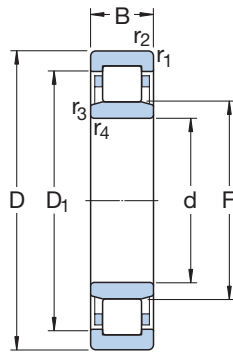

Type NU

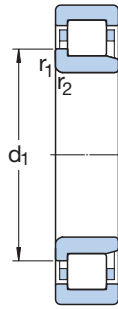

Type NJ

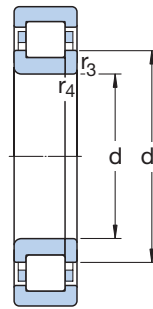

Type NUP



Type N

Principal dimensions			Basic load ratings		Fatigue load limit P _u	Speed ratings		Mass Bearing with standard cage	Designations Bearing with standard cage	Alternative standard cage designs ¹⁾
d	D	B	C	C ₀		Reference speed	Limiting speed			
mm			kN		kN	r/min		kg	–	
85 cont.	180	41	340	335	41,5	4 000	4 800	4,70	NU 317 ECP	J, M
	180	41	340	335	41,5	4 000	4 800	4,80	NJ 317 ECP	J, M
	180	41	340	335	41,5	4 000	4 800	4,90	NUP 317 ECP	J, M
	180	41	340	335	41,5	4 000	4 800	4,70	N 317 ECP	M
	180	60	455	490	60	4 000	4 800	6,85	NU 2317 ECP	J, ML
	180	60	455	490	60	4 000	4 800	7,00	NJ 2317 ECP	ML
	180	60	455	490	60	4 000	4 800	7,00	NUP 2317 ECP	ML
	210	52	319	335	39	3 600	4 300	9,70	NU 417	–
	210	52	319	335	39	3 800	4 300	8,90	NJ 417	–
90	140	24	80,9	104	12,7	5 600	8 500	1,35	NU 1018 ML	–
	160	30	208	220	27	4 500	5 000	2,35	NU 218 ECP	J, M, ML
	160	30	208	220	27	4 500	5 000	2,40	NJ 218 ECP	J, M, ML
	160	30	208	220	27	4 500	5 000	2,45	NUP 218 ECP	M, ML
	160	30	208	220	27	4 500	5 000	2,35	N 218 ECP	M
	160	40	280	315	39	4 500	5 000	3,15	NU 2218 ECP	J, M, ML
	160	40	280	315	39	4 500	5 000	3,20	NJ 2218 ECP	M, ML
	160	40	280	315	39	4 500	5 000	3,30	NUP 2218 ECP	–
	190	43	365	360	43	3 800	4 500	5,45	NU 318 ECP	J, M, ML
	190	43	365	360	43	3 800	4 500	5,55	NJ 318 ECP	J, M, ML
	190	43	365	360	43	3 800	4 500	5,65	NUP 318 ECP	M, ML
	190	43	365	360	43	3 800	4 500	5,40	N 318 ECP	M
	190	64	500	540	65,5	3 800	4 500	8,00	NU 2318 ECP	J, ML
	190	64	500	540	65,5	3 800	4 500	8,15	NJ 2318 ECP	J, ML, M
	190	64	500	540	65,5	3 800	4 500	8,30	NUP 2318 ECP	ML
	225	54	380	415	48	3 400	4 000	11,5	NU 418	–
95	145	24	84,2	110	13,2	5 300	8 000	1,40	NU 1019 ML	–
	170	32	255	265	32,5	4 300	4 800	2,85	NU 219 ECP	J, M, ML
	170	32	255	265	32,5	4 300	4 800	2,90	NJ 219 ECP	J, M, ML
	170	32	255	265	32,5	4 300	4 800	3,00	NUP 219 ECP	ML
	170	32	255	265	32,5	4 300	4 800	2,85	N 219 ECP	–
	170	43	325	375	45,5	4 300	4 800	3,85	NU 2219 ECP	J, M
	170	43	325	375	45,5	4 300	4 800	3,95	NJ 2219 ECP	J, M
	170	43	325	375	45,5	4 300	4 800	4,00	NUP 2219 ECP	–

The designations of SKF Explorer class bearings are printed in blue

¹⁾ When ordering bearings with an alternative standard cage the suffix of the standard cage has to be replaced by the suffix of the cage in question. e.g. NU 317 ECP becomes NU 317 ECM

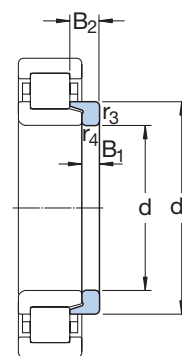
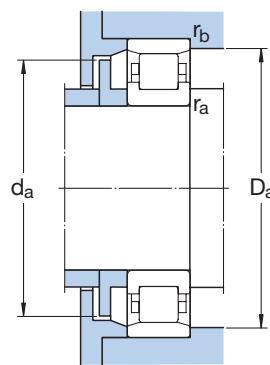
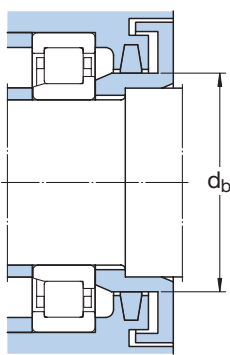
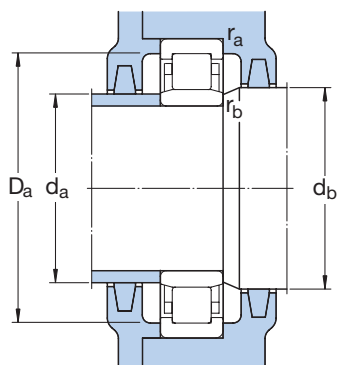

Angle ring

3

Dimensions							Abutment and fillet dimensions						Calculation factor k_r	Angle ring Designation	Mass	Dimensions	
d	d_1 ~	D_1 ~	F, E	$r_{1,2}$ min	$r_{3,4}$ min	$s^{1)}$	d_a min	d_a max	d_b, D_a min	D_a max	r_a max	r_b max				B_1	B_2
mm							mm						-	-	kg	mm	
85 cont.	117	153	108	3	3	2,3	99	105	111	166	2,5	2,5	0,15	HJ 317 EC	0,55	12	18,5
	117	153	108	3	3	2,3	99	105	120	166	2,5	2,5	0,15	HJ 317 EC	0,55	12	18,5
	117	153	108	3	3	-	99	-	120	166	2,5	2,5	0,15	-	-	-	-
	117	-	160	3	3	2,3	99	157	163	166	2,5	2,5	0,15	-	-	-	-
	-	153	108	3	3	5,8	99	105	111	166	2,5	2,5	0,25	-	-	-	-
	117	153	108	3	3	5,8	99	105	120	166	2,5	2,5	0,25	-	-	-	-
	117	153	108	3	3	-	99	-	120	166	2,5	2,5	0,25	-	-	-	-
	-	163	113	4	4	3,8	105	109	116	190	3	3	0,15	-	-	-	-
126	163	113	4	4	3,8	105	109	129	190	3	3	0,15	-	-	-	-	
90	-	122	103	1,5	1,1	3,5	96	101	106	133	1,5	1	0,1	-	-	-	-
	114	140	107	2	2	1,8	101	104	110	149	2	2	0,15	HJ 218 EC	0,31	9	14
	114	140	107	2	2	1,8	101	104	117	149	2	2	0,15	HJ 218 EC	0,31	9	14
	114	140	107	2	2	-	101	-	117	149	2	2	0,15	-	-	-	-
	114	-	145	2	2	1,8	101	142	148	149	2	2	0,15	-	-	-	-
	-	140	107	2	2	2,6	101	104	110	149	2	2	0,2	-	-	-	-
	114	140	107	2	2	2,6	101	104	117	149	2	2	0,2	-	-	-	-
	114	140	107	2	2	-	101	-	117	149	2	2	0,2	-	-	-	-
	124	162	113,5	3	3	2,5	104	110	116	176	2,5	2,5	0,15	HJ 318 EC	0,60	12	18,5
	124	162	113,5	3	3	2,5	104	110	127	176	2,5	2,5	0,15	HJ 318 EC	0,60	12	18,5
	124	162	113,5	3	3	-	104	-	127	176	2,5	2,5	0,15	-	-	-	-
	124	-	169,5	3	3	2,5	104	166	173	176	2,5	2,5	0,15	-	-	-	-
	124	162	113,5	3	3	6	104	110	116	176	2,5	2,5	0,25	-	-	-	-
	124	162	113,5	3	3	6	104	110	127	176	2,5	2,5	0,25	-	-	-	-
	124	162	113,5	3	3	-	104	110	127	176	2,5	2,5	0,25	-	-	-	-
	-	176	123,5	4	4	4,9	106	120	126	209	3	3	0,15	-	-	-	-
95	-	127	108	1,5	1,1	3,5	101	106	111	138	1,5	1	0,1	-	-	-	-
	120	149	112,5	2,1	2,1	1,7	107	110	115	158	2	2	0,15	HJ 219 EC	0,33	9	14
	120	149	112,5	2,1	2,1	1,7	107	110	123	158	2	2	0,15	HJ 219 EC	0,33	9	14
	120	149	112,5	2,1	2,1	-	107	-	123	158	2	2	0,15	-	-	-	-
	120	-	154,5	2,1	2,1	1,7	107	152	157	158	2	2	0,15	-	-	-	-
	-	149	112,5	2,1	2,1	3	107	110	115	158	2	2	0,2	-	-	-	-
	120	149	112,5	2,1	2,1	3	107	110	123	158	2	2	0,2	-	-	-	-
	120	149	112,5	2,1	2,1	-	107	-	123	158	2	2	0,2	-	-	-	-

¹⁾ Permissible axial displacement from normal position of one ring in relation to the other

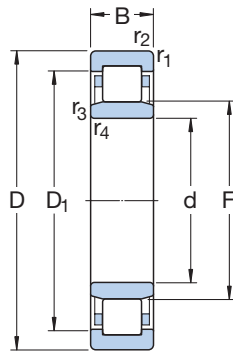

Type NU

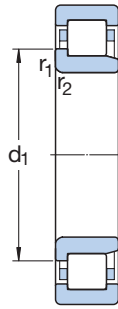

Type NJ

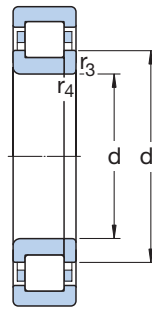

Type NUP

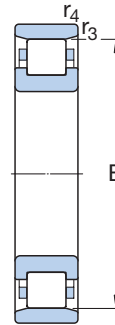

Type N

Principal dimensions			Basic load ratings		Fatigue load limit P _u	Speed ratings		Mass Bearing with standard cage	Designations Bearing with standard cage	Alternative standard cage designs ¹⁾
d	D	B	C	C ₀		Reference speed	Limiting speed			
mm			kN		kN	r/min		kg	–	
95 cont.	200	45	390	390	46,5	3 600	4 300	6,25	NU 319 ECP	J, M, ML
	200	45	390	390	46,5	3 600	4 300	6,45	NJ 319 ECP	J, M, ML
	200	45	390	390	46,5	3 600	4 300	6,25	NUP 319 ECP	M, ML
	200	45	390	390	46,5	3 600	4 300	6,25	N 319 ECP	M
	200	67	530	585	69,5	3 600	4 300	9,65	NU 2319 ECP	J, ML
	200	67	530	585	69,5	3 600	4 300	9,85	NJ 2319 ECP	J, ML
	200	67	530	585	69,5	3 600	4 300	9,75	NUP 2319 ECP	J, ML
	240	55	413	455	52	3 200	3 600	13,5	NU 419 M	–
100	150	24	85,8	114	13,7	5 000	7 500	1,45	NU 1020 ML	M
	180	34	285	305	36,5	4 000	4 500	3,45	NU 220 ECP	J, M, ML
	180	34	285	305	36,5	4 000	4 500	3,50	NJ 220 ECP	J, M, ML
	180	34	285	305	36,5	4 000	4 500	3,60	NUP 220 ECP	ML
	180	34	285	305	36,5	4 000	4 500	3,45	N 220 ECP	–
	180	46	380	450	54	4 000	4 500	4,75	NU 2220 ECP	J, ML
	180	46	380	450	54	4 000	4 500	4,80	NJ 2220 ECP	J, ML
	180	46	380	450	54	4 000	4 500	4,90	NUP 2220 ECP	ML
	215	47	450	440	51	3 200	3 800	7,85	NU 320 ECP	J, M, ML
	215	47	450	440	51	3 200	3 800	7,65	NJ 320 ECP	J, M, ML
	215	47	450	440	51	3 200	3 800	7,80	NUP 320 ECJ	ML
	215	47	450	440	51	3 200	3 800	7,55	N 320 ECP	M
	215	73	670	735	85	3 200	3 800	12,0	NU 2320 ECP	J, ML
	215	73	670	735	85	3 200	3 800	12,2	NJ 2320 ECP	J, ML
	215	73	670	735	85	3 200	3 800	12,5	NUP 2320 ECP	J, ML
	250	58	429	475	53	3 000	3 600	14,0	NU 420 M	–
105	160	26	101	137	16	4 800	7 500	1,85	NU 1021 ML	M
	190	36	300	315	36,5	3 800	4 300	4,00	NU 221 ECP	J, ML
	190	36	300	315	36,5	3 800	4 300	4,10	NJ 221 ECP	ML
	190	36	300	315	36,5	3 800	4 300	4,20	NUP 221 ECP	ML
	190	36	300	315	36,5	3 800	4 300	3,95	N 221 ECP	–
	225	49	500	500	57	3 200	3 800	8,75	NU 321 ECP	J, ML
	225	49	500	500	57	3 200	3 800	9,00	NJ 321 ECJ	ML
	225	49	500	500	57	3 200	3 800	8,65	N 321 ECP	–
	260	60	501	570	64	2 800	3 400	19,0	NU 421 M	–

The designations of SKF Explorer class bearings are printed in blue

¹⁾ When ordering bearings with an alternative standard cage the suffix of the standard cage has to be replaced by the suffix of the cage in question. e.g. NU 319 ECP becomes NU 319 ECML

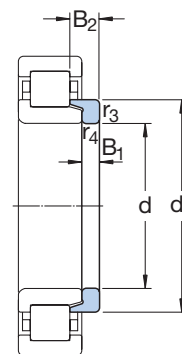
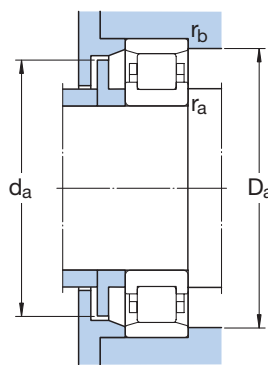
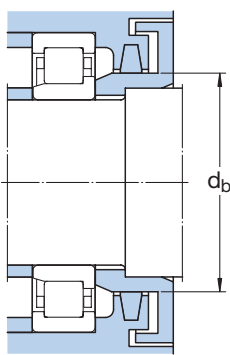
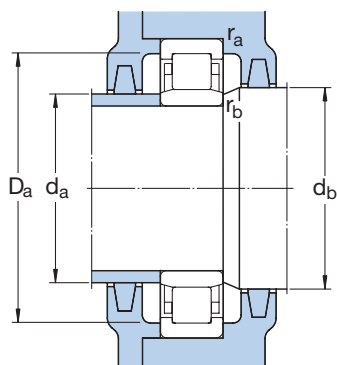

Angle ring

3

Dimensions							Abutment and fillet dimensions						Calculation factor k_r	Angle ring Designation	Mass	Dimensions	
d	d_1	D_1	F, E	$r_{1,2}$ min	$r_{3,4}$ min	$s^1)$	d_a min	d_a max	d_b, D_a min	D_a max	r_a max	r_b max				B_1	B_2
mm							mm						-	-	kg	mm	
95	132	170	121,5	3	3	2,9	109	118	124	186	2,5	2,5	0,15	HJ 319 EC	0,76	13	20,5
	cont. 132	170	121,5	3	3	2,9	109	118	135	186	2,5	2,5	0,15	HJ 319 EC	0,76	13	20,5
	132	170	121,5	3	3	-	109	-	135	186	2,5	2,5	0,15	-	-	-	-
	132	-	177,5	3	3	2,9	109	174	181	186	2,5	2,5	0,15	-	-	-	-
	132	170	121,5	3	3	6,9	109	118	124	186	2,5	2,5	0,25	HJ 2319 EC	0,81	13	24,5
	132	170	121,5	3	3	6,9	109	118	135	186	2,5	2,5	0,25	HJ 2319 EC	0,81	13	24,5
	132	170	121,5	3	3	-	109	-	135	186	2,5	2,5	0,25	-	-	-	-
	-	186	133,5	4	4	5	115	130	136	220	3	3	0,15	-	-	-	-
100	-	132	113	1,5	1,1	3,5	106	111	116	143	1,5	1	0,1	-	-	-	-
	127	157	119	2,1	2,1	1,7	112	116	122	168	2	2	0,15	HJ 220 EC	0,42	10	15
	127	157	119	2,1	2,1	1,7	112	116	130	168	2	2	0,15	HJ 220 EC	0,42	10	15
	127	157	119	2,1	2,1	-	112	-	130	168	2	2	0,15	-	-	-	-
	127	-	163	2,1	2,1	1,7	112	160	166	168	2	2	0,15	-	-	-	-
	127	157	119	2,1	2,1	2,5	112	116	122	168	2	2	0,2	HJ 2220 EC	0,43	10	16
	127	157	119	2,1	2,1	2,5	112	116	130	168	2	2	0,2	HJ 2220 EC	0,43	10	16
	127	157	119	2,1	2,1	-	112	-	130	168	2	2	0,2	-	-	-	-
	139	182	127,5	3	3	2,9	114	124	130	201	2,5	2,5	0,15	HJ 320 EC	0,87	13	20,5
	139	182	127,5	3	3	2,9	114	124	142	201	2,5	2,5	0,15	HJ 320 EC	0,87	13	20,5
	139	182	127,5	3	3	-	114	-	142	201	2,5	2,5	0,15	-	-	-	-
	139	-	191,5	3	3	2,9	114	188	195	201	2,5	2,5	0,15	-	-	-	-
	139	182	127,5	3	3	5,9	114	124	130	201	2,5	2,5	0,25	HJ 2320 EC	0,93	13	23,5
	139	182	127,5	3	3	5,9	114	124	142	201	2,5	2,5	0,25	HJ 2320 EC	0,93	13	23,5
	139	182	127,5	3	3	-	114	-	142	201	2,5	2,5	0,25	-	-	-	-
	-	195	139	4	4	4,9	120	135	142	230	3	3	0,15	-	-	-	-
105	-	140	119,5	2	1,1	3,8	111	117	122	151	2	1	0,1	-	-	-	-
	-	164	125	2,1	2,1	2	117	122	128	178	2	2	0,15	-	-	-	-
	134	164	125	2,1	2,1	2	117	122	137	178	2	2	0,15	-	-	-	-
	134	164	125	2,1	2,1	-	117	-	137	178	2	2	0,15	-	-	-	-
	134	-	173	2,1	2,1	2	117	170	176	178	2	2	0,15	-	-	-	-
	-	190	133	3	3	3,4	119	130	136	211	2,5	2,5	0,15	-	-	-	-
	145	190	133	3	3	3,4	119	130	148	211	2,5	2,5	0,15	-	-	-	-
	145	-	201	3	3	3,4	119	198	203	211	2,5	2,5	0,15	-	-	-	-
	-	203	144,5	4	4	4,9	125	140	147	240	3	3	0,15	-	-	-	-

¹⁾ Permissible axial displacement from normal position of one ring in relation to the other

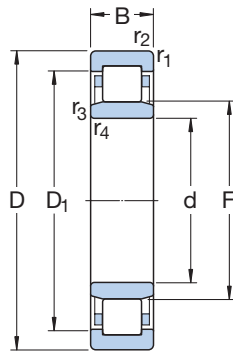

Type NU



Type NJ

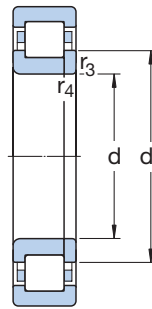

Type NUP



Type N

Principal dimensions			Basic load ratings		Fatigue load limit P _u	Speed ratings		Mass Bearing with standard cage	Designations Bearing with standard cage	Alternative standard cage designs ¹⁾
d	D	B	C	C ₀		Reference speed	Limiting speed			
mm			kN		kN	r/min		kg	–	
110	170	28	128	166	19,3	4 500	7 000	2,30	NU 1022 ML	M
	200	38	335	365	42,5	3 600	4 000	4,80	NU 222 ECP	J, M, ML
	200	38	335	365	42,5	3 600	4 000	4,90	NJ 222 ECP	J, M, ML
	200	38	335	365	42,5	3 600	4 000	5,00	NUP 222 ECP	ML
	200	38	335	365	42,5	3 600	4 000	4,80	N 222 ECP	M
	200	53	440	520	61	3 600	4 000	6,70	NU 2222 ECP	J, ML
	200	53	440	520	61	3 600	4 000	6,85	NJ 2222 ECP	J, ML
	200	53	440	520	61	3 600	4 000	7,00	NUP 2222 ECP	ML
	240	50	530	540	61	3 000	3 400	10,8	NU 322 ECP	J, M, ML
	240	50	530	540	61	3 000	3 400	11,1	NJ 322 ECP	J, M, ML
	240	50	530	540	61	3 000	3 400	11,2	NUP 322 ECP	J, ML
	240	50	530	540	61	3 000	3 400	10,5	N 322 ECP	M
	240	80	780	900	102	3 000	3 400	17,0	NU 2322 ECP	MA
	240	80	780	900	102	3 000	3 400	18,9	NJ 2322 ECP	MA
	240	80	780	900	102	3 000	3 400	18,9	NUP 2322 ECP	MA
	280	65	532	585	64	2 600	3 200	20,0	NU 422	–
280	65	532	585	64	2 600	3 200	20,3	NJ 422	–	
120	180	28	134	183	20,8	4 000	6 300	2,45	NU 1024 ML	M
	215	40	390	430	49	3 400	3 600	5,75	NU 224 ECP	J, M, ML
	215	40	390	430	49	3 400	3 600	5,85	NJ 224 ECP	J, M, ML
	215	40	390	430	49	3 400	3 600	6,00	NUP 224 ECJ	ML
	215	40	390	430	49	3 400	3 600	5,75	N 224 ECP	M
	215	58	520	630	72	3 400	3 600	8,30	NU 2224 ECP	J, M, ML
	215	58	520	630	72	3 400	3 600	8,50	NJ 2224 ECP	J, M, ML
	215	58	520	630	72	3 400	3 600	9,00	NUP 2224 ECP	ML
	260	55	610	620	69,5	2 800	3 200	13,3	NU 324 ECP	J, M, ML
	260	55	610	620	69,5	2 800	3 200	13,5	NJ 324 ECP	J, M, ML
	260	55	610	620	69,5	2 800	3 200	13,7	NUP 324 ECP	ML
	260	55	610	620	69,5	2 800	3 200	13,2	N 324 ECP	M
	260	86	915	1 040	116	2 800	3 200	24,0	NU 2324 ECMA	–
	260	86	915	1 040	116	2 800	3 200	24,3	NJ 2324 ECMA	M
	260	86	915	1 040	116	2 800	3 200	24,3	NUP 2324 ECMA	–
	310	72	644	735	78	2 400	2 800	28,0	NU 424	–

The designations of SKF Explorer class bearings are printed in blue

¹⁾ When ordering bearings with an alternative standard cage the suffix of the standard cage has to be replaced by the suffix of the cage in question. e.g. NU 222 ECP becomes NU 222 ECML

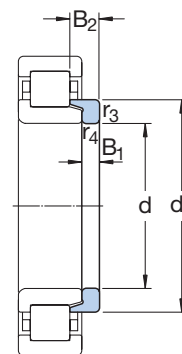
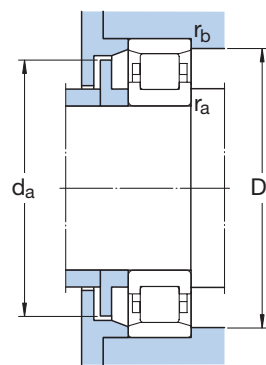
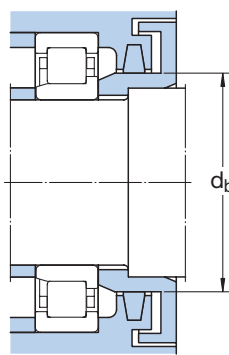
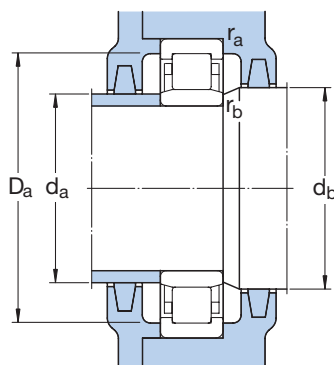

Angle ring

3

Dimensions							Abutment and fillet dimensions						Calculation factor k_r	Angle ring Designation	Mass	Dimensions	
d	d_1	D_1	F, E	$r_{1,2}$ min	$r_{3,4}$ min	$s^1)$	d_a min	d_a max	d_b, D_a min	D_a max	r_a max	r_b max				B_1	B_2
mm							mm						-	-	kg	mm	
110	-	149	125	2	1,1	3,8	116	123	128	161	2	1	0,1	-	-	-	-
	141	174	132,5	2,1	2,1	2,1	122	130	135	188	2	2	0,15	HJ 222 EC	0,60	11	17
	141	174	132,5	2,1	2,1	2,1	122	130	145	188	2	2	0,15	HJ 222 EC	0,60	11	17
	141	174	132,5	2,1	2,1	-	122	-	145	188	2	2	0,15	-	-	-	-
	141	-	180,5	2,1	2,1	2,1	122	177	183	188	2	2	0,15	-	-	-	-
	-	174	132,5	2,1	2,1	3,7	122	129	135	188	2	2	0,2	-	-	-	-
	141	174	132,5	2,1	2,1	3,7	122	129	145	188	2	2	0,2	-	-	-	-
	141	174	132,5	2,1	2,1	-	122	-	145	188	2	2	0,2	-	-	-	-
	155	201	143	3	3	3	124	139	146	226	2,5	2,5	0,15	HJ 322 EC	1,20	14	22
	155	201	143	3	3	3	124	139	159	226	2,5	2,5	0,15	HJ 322 EC	1,20	14	22
	155	201	143	3	3	-	124	-	159	226	2,5	2,5	0,15	-	-	-	-
	155	-	211	3	3	3	124	208	215	226	2,5	2,5	0,15	-	-	-	-
	-	201	143	3	3	7,5	124	139	146	226	2,5	2,5	0,25	-	-	-	-
	155	201	143	3	3	7,5	124	139	159	226	2,5	2,5	0,25	-	-	-	-
	155	201	143	3	3	-	124	-	159	226	2,5	2,5	0,25	-	-	-	-
	171	217	155	4	4	4,8	130	150	158	260	3	3	0,15	HJ 422	2,10	17	29,5
	171	217	155	4	4	4,8	130	150	174	260	3	3	0,15	HJ 422	2,10	17	29,5
120	-	159	135	2	1,1	3,8	126	133	138	171	2	1	0,1	-	-	-	-
	153	188	143,5	2,1	2,1	1,9	132	140	146	203	2	2	0,15	HJ 224 EC	0,69	11	17
	153	188	143,5	2,1	2,1	1,9	132	140	156	203	2	2	0,15	HJ 224 EC	0,69	11	17
	153	188	143,5	2,1	2,1	-	132	-	156	203	2	2	0,15	-	-	-	-
	153	-	195,5	2,1	2,1	1,9	132	192	199	203	2	2	0,15	-	-	-	-
	153	188	143,5	2,1	2,1	3,8	132	140	146	203	2	2	0,2	HJ 2224 EC	0,74	11	20
	153	188	143,5	2,1	2,1	3,8	132	140	156	203	2	2	0,2	HJ 2224 EC	0,74	11	20
	153	188	143,5	2,1	2,1	-	132	-	156	203	2	2	0,2	-	-	-	-
	168	219	154	3	3	3,7	134	150	157	246	2,5	2,5	0,15	HJ 324 EC	1,40	14	22,5
	168	219	154	3	3	3,7	134	150	171	246	2,5	2,5	0,15	HJ 324 EC	1,40	14	22,5
	168	219	154	3	3	-	134	-	171	246	2,5	2,5	0,15	-	-	-	-
	168	-	230	3	3	3,7	134	226	234	246	2,5	2,5	0,15	-	-	-	-
	168	219	154	3	3	7,2	134	150	157	246	2,5	2,5	0,25	HJ 2324 EC	1,45	14	26
	168	219	154	3	3	7,2	134	150	171	246	2,5	2,5	0,25	HJ 2324 EC	1,45	14	26
	168	219	154	3	3	-	134	-	171	246	2,5	2,5	0,25	-	-	-	-
	188	240	170	5	5	6,3	144	165	173	286	4	4	0,15	HJ 424	2,60	17	30,5

¹⁾ Permissible axial displacement from normal position of one ring in relation to the other

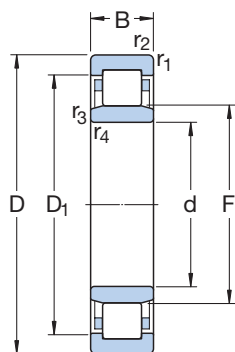

Type NU

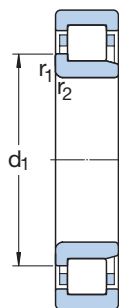

Type NJ

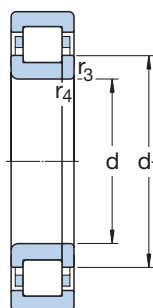

Type NUP

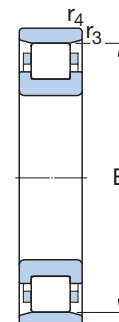

Type N

Principal dimensions			Basic load ratings		Fatigue load limit P _u	Speed ratings		Mass Bearing with standard cage	Designations Bearing with standard cage	Alternative standard cage designs ¹⁾
d	D	B	C	C ₀		Reference speed	Limiting speed			
mm			kN		kN	r/min		kg	–	
130	200	33	165	224	25	3 800	5 600	3,80	NU 1026 ML	M
	230	40	415	455	51	3 200	3 400	6,45	NU 226 ECP	J, M, ML
	230	40	415	455	51	3 200	3 400	6,60	NJ 226 ECP	J, M, ML
	230	40	415	455	51	3 200	3 400	6,75	NUP 226 ECP	J, ML
	230	40	415	455	51	3 200	3 400	6,30	N 226 ECP	–
	230	64	610	735	83	3 200	3 400	10,5	NU 2226 ECP	ML
	230	64	610	735	83	3 200	3 400	12,2	NJ 2226 ECP	ML
	230	64	610	735	83	3 200	3 400	12,2	NUP 2226 ECP	ML
	280	58	720	750	81,5	2 400	3 000	16,5	NU 326 ECP	J, M, ML
	280	58	720	750	81,5	2 400	3 000	18,4	NJ 326 ECP	J, M, ML
	280	58	720	750	81,5	2 400	3 000	19,6	NUP 326 ECP	ML
	280	58	720	750	81,5	2 400	3 000	18,5	N 326 ECP	M
	280	93	1 060	1 250	137	2 400	3 000	30,0	NU 2326 ECMA	–
	280	93	1 060	1 250	137	2 400	3 000	30,5	NJ 2326 ECMA	–
	280	93	1 060	1 250	137	2 400	3 000	31,0	NUP 2326 ECMA	–
	140	210	33	172	245	27	3 600	5 300	4,05	NU 1028 ML
250		42	450	510	57	2 800	3 200	8,50	NU 228 ECM	J, ML
250		42	450	510	57	2 800	3 200	8,75	NJ 228 ECM	J, ML
250		42	450	510	57	2 800	3 200	8,90	NUP 228 ECM	ML
250		68	655	830	93	2 800	4 800	15,0	NU 2228 ECML	–
250		68	655	830	93	2 800	4 800	15,3	NJ 2228 ECML	–
250		68	655	830	93	2 800	4 800	15,6	NUP 2228 ECML	–
300		62	780	830	88	2 400	2 800	22,7	NU 328 ECM	J, ML
300		62	780	830	88	2 400	2 800	23,0	NJ 328 ECM	J, ML
300		62	780	830	88	2 400	2 800	23,5	NUP 328 ECM	ML
300		102	1 200	1 430	150	2 400	3 600	37,0	NU 2328 ECMA	–
300		102	1 200	1 430	150	2 400	3 600	37,5	NJ 2328 ECMA	–
300		102	1 200	1 430	150	2 400	3 600	38,0	NUP 2328 ECMA	–

The designations of SKF Explorer class bearings are printed in blue

¹⁾ When ordering bearings with an alternative standard cage the suffix of the standard cage has to be replaced by the suffix of the cage in question. e.g. NU 226 ECP becomes NU 226 ECML

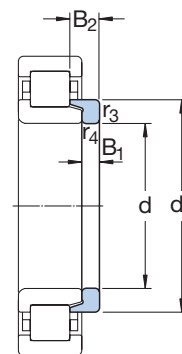
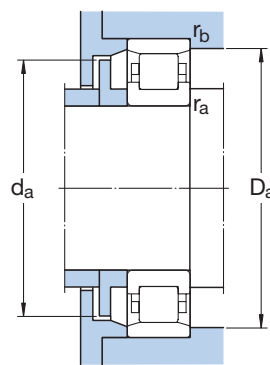
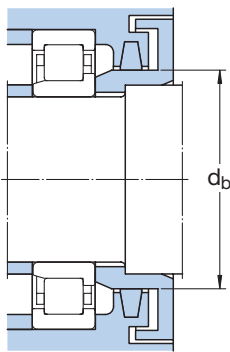
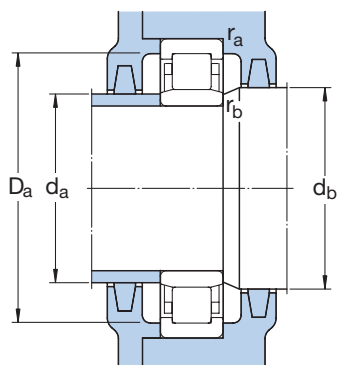

Angle ring

3

Dimensions							Abutment and fillet dimensions						Calculation factor k_r	Angle ring Designation	Mass	Dimensions	
d	d_1	D_1	F, E	$r_{1,2}$ min	$r_{3,4}$ min	$s^1)$	d_a min	d_a max	d_b, D_a min	D_a max	r_a max	r_b max				B_1	B_2
mm							mm						-	-	kg	mm	
130	-	175	148	2	1,1	4,7	136	145	151	191	2	1	0,1	-	-	-	-
	164	202	153,5	3	3	2,1	144	150	156	216	2,5	2,5	0,15	HJ 226 EC	0,75	11	17
	164	202	153,5	3	3	2,1	144	150	167	216	2,5	2,5	0,15	HJ 226 EC	0,75	11	17
	164	202	153,5	3	3	-	144	-	167	216	2,5	2,5	0,15	-	-	-	-
	164	-	209,5	3	3	2,1	144	206	213	216	2,5	2,5	0,15	-	-	-	-
	164	202	153,5	3	3	4,3	144	149	156	216	2,5	2,5	0,2	HJ 2226 EC	0,83	11	21
	164	202	153,5	3	3	4,3	144	149	167	216	2,5	2,5	0,2	HJ 2226 EC	0,83	11	21
	164	202	153,5	3	3	-	144	-	167	216	2,5	2,5	0,2	-	-	-	-
	181	236	167	4	4	3,7	147	163	170	263	3	3	0,15	HJ 326 EC	1,60	14	23
	181	236	167	4	4	3,7	147	163	185	263	3	3	0,15	HJ 326 EC	1,60	14	23
	181	236	167	4	4	-	147	-	185	263	3	3	0,15	-	-	-	-
	181	-	247	4	4	3,7	147	243	251	263	3	3	0,15	-	-	-	-
	181	236	167	4	4	8,7	147	163	170	263	3	3	0,25	HJ 2326 EC	1,70	14	28
	181	236	167	4	4	8,7	147	163	185	263	3	3	0,25	HJ 2326 EC	1,70	14	28
	181	236	167	4	4	-	147	-	185	263	3	3	0,25	-	-	-	-
140	-	185	158	2	1,1	4,4	146	155	161	201	2	1	0,1	-	-	-	-
	-	217	169	3	3	2,5	154	166	172	236	2,5	2,5	0,15	-	-	-	-
	179	217	169	3	3	2,5	154	166	183	236	2,5	2,5	0,15	-	-	-	-
	179	217	169	3	3	-	154	-	183	236	2,5	2,5	0,15	-	-	-	-
	179	217	169	3	3	4,4	154	164	172	236	2,5	2,5	0,2	HJ 2228 EC	1,05	11	23
	179	217	169	3	3	4,4	154	164	183	236	2,5	2,5	0,2	HJ 2228 EC	1,05	11	23
	179	217	169	3	3	-	154	-	183	236	2,5	2,5	0,2	-	-	-	-
	195	252	180	4	4	3,7	157	176	183	283	3	3	0,15	HJ 328 EC	2,00	15	25
	195	252	180	4	4	3,7	157	176	199	283	3	3	0,15	HJ 328 EC	2,00	15	25
	195	252	180	4	4	-	157	-	199	283	3	3	0,15	-	-	-	-
	195	252	180	4	4	9,7	157	176	183	283	3	3	0,25	HJ 2328 EC	2,15	15	31
	195	252	180	4	4	9,7	157	176	199	283	3	3	0,25	HJ 2328 EC	2,15	15	31
	195	252	180	4	4	-	157	-	199	283	3	3	0,25	-	-	-	-

¹⁾ Permissible axial displacement from normal position of one ring in relation to the other

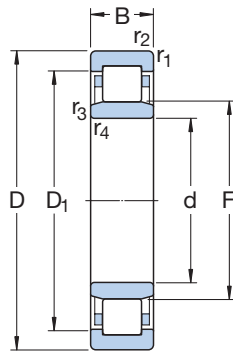

Type NU



Type NJ

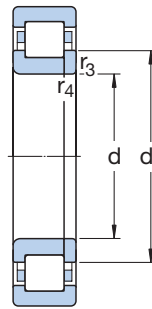

Type NUP



Type N

Principal dimensions			Basic load ratings		Fatigue load limit P _u	Speed ratings		Mass Bearing with standard cage	Designations Bearing with standard cage	Alternative standard cage designs ¹⁾	
d	D	B	C	C ₀		Reference speed	Limiting speed				
mm			kN		kN	r/min		kg	–		
150	225	35	194	275	30	3 200	5 000	4,85	NU 1030 ML	M	
	270	45	510	600	64	2 600	2 800	11,8	NU 230 ECM	J, ML	
	270	45	510	600	64	2 600	2 800	12,0	NJ 230 ECM	J, ML	
	270	45	510	600	64	2 600	2 800	12,2	NUP 230 ECM	ML	
	270	73	735	930	100	2 600	2 800	20,0	NU 2230 ECM	–	
	270	73	735	930	100	2 600	2 800	20,3	NJ 2230 ECM	–	
	320	65	900	965	100	2 200	2 600	27,5	NU 330 ECM	MA	
	320	65	900	965	100	2 200	2 600	28,0	NJ 330 ECM	MA	
	320	108	1 370	1 630	166	2 200	3 400	45,5	NU 2330 ECMA	–	
	320	108	1 370	1 630	166	2 200	3 400	46,0	NJ 2330 ECMA	–	
	320	108	1 370	1 630	166	2 200	3 400	46,5	NUP 2330 ECMA	–	
	160	240	38	229	325	35,5	3 000	4 800	5,95	NU 1032 ML	M
		290	48	585	680	72	2 400	2 600	14,5	NU 232 ECM	ML
		290	48	585	680	72	2 400	2 600	15,0	NJ 232 ECM	ML
290		48	585	680	72	2 400	2 600	15,5	NUP 232 ECM	ML	
290		48	585	680	72	2 400	2 600	15,5	N 232 ECM	–	
290		80	930	1 200	129	2 400	3 600	24,0	NU 2232 ECMA	–	
290		80	930	1 200	129	2 400	3 600	24,5	NJ 2232 ECMA	–	
340		68	1 000	1 080	112	2 000	2 400	33,0	NU 332 ECM	MA	
340		68	1 000	1 080	112	2 000	2 400	33,5	NJ 332 ECM	MA	
340		114	1 250	1 730	173	1 800	2 800	53,0	NU 2332 ECMA	–	
340		114	1 250	1 730	173	1 800	2 800	53,5	NJ 2332 ECMA	–	
170		260	42	275	400	41,5	2 800	4 300	8,15	NU 1034 ML	M
		310	52	695	815	85	2 200	2 400	19,0	NU 234 ECM	MA
		310	52	695	815	85	2 200	2 400	19,5	NJ 234 ECM	MA
	310	52	695	815	85	2 200	2 400	20,0	NUP 234 ECM	MA	
	310	86	1 060	1 340	140	2 200	3 200	30,0	NU 2234 ECMA	–	
	360	72	952	1 180	116	1 700	2 200	37,5	NU 334 ECM	MA	
	360	72	952	1 180	116	1 700	2 200	38,5	N 334 ECM	–	
	360	120	1 450	2 040	204	1 700	3 000	62,0	NU 2334 ECMA	–	
	360	120	1 450	2 040	204	1 700	3 000	63,0	NJ 2334 ECMA	–	

The designations of SKF Explorer class bearings are printed in blue

¹⁾ When ordering bearings with an alternative standard cage the suffix of the standard cage has to be replaced by the suffix of the cage in question. e.g. NU 230 ECM becomes NU 230 ECML

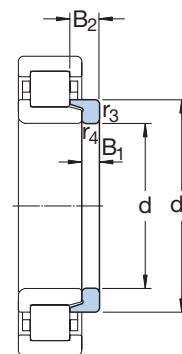
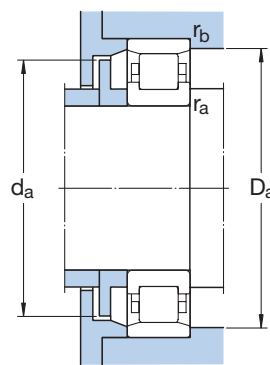
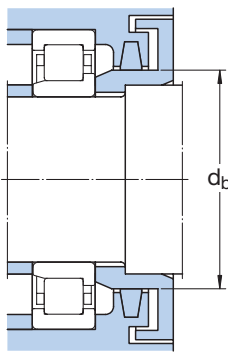
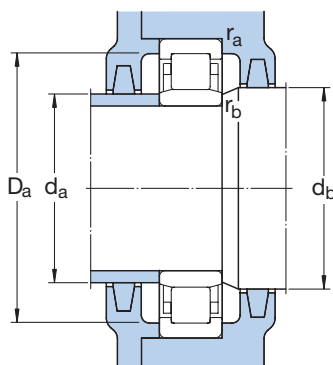

Angle ring

3

Dimensions							Abutment and fillet dimensions						Calculation factor k_r	Angle ring Designation	Mass	Dimensions	
d	d ₁	D ₁	F, E	r _{1,2} min	r _{3,4} min	s ¹⁾	d _a min	d _a max	d _b , D _a min	D _a max	r _a max	r _b max				B ₁	B ₂
mm							mm						-	-	kg	mm	
150	-	198	169,5	2,1	1,5	4,9	157	167	173	215	2	1,5	0,1	-	-	-	-
	193	234	182	3	3	2,5	163	178	185	256	2,5	2,5	0,15	HJ 230 EC	1,25	12	19,5
	193	234	182	3	3	2,5	164	178	197	256	2,5	2,5	0,15	HJ 230 EC	1,25	12	19,5
	193	234	182	3	3	-	164	-	197	256	2,5	2,5	0,15	-	-	-	-
	194	234	182	3	3	4,9	164	179	185	256	2,5	2,5	0,2	HJ 2230 EC	1,35	12	24,5
	194	234	182	3	3	4,9	164	179	197	256	2,5	2,5	0,2	HJ 2230 EC	1,35	12	24,5
	-	270	193	4	4	4	167	189	196	303	3	3	0,15	-	-	-	-
	209	270	193	4	4	4	167	189	213	303	3	3	0,15	-	-	-	-
	209	270	193	4	4	10,5	167	189	196	303	3	3	0,25	-	-	-	-
	209	270	193	4	4	10,5	167	189	213	303	3	3	0,25	-	-	-	-
209	270	193	4	4	-	167	-	213	303	3	3	0,25	-	-	-	-	
160	188	211	180	2,1	1,5	5,2	167	177	183	230	2	1,5	0,1	HJ 1032	0,65	10	19
	-	250	195	3	3	2,7	174	191	198	276	2,5	2,5	0,15	-	-	-	-
	206	250	195	3	3	2,7	174	191	210	276	2,5	2,5	0,15	-	-	-	-
	206	250	195	3	3	-	174	-	210	276	2,5	2,5	0,15	-	-	-	-
	206	-	259	3	3	2,7	174	255	263	276	2,5	2,5	0,15	-	-	-	-
	205	252	193	3	3	4,5	174	188	196	276	2,5	2,5	0,2	HJ 2232 EC	1,55	12	24,5
	205	252	193	3	3	4,5	174	188	209	276	2,5	2,5	0,2	HJ 2232 EC	1,55	12	24,5
	221	286	204	4	4	4	177	200	207	323	3	3	0,15	HJ 332 EC	2,55	15	25
	221	286	204	4	4	4	177	200	225	323	3	3	0,15	HJ 332 EC	2,55	15	25
	-	286	204	4	4	11	177	200	207	323	3	3	0,25	-	-	-	-
221	286	204	4	4	11	177	200	225	323	3	3	0,25	-	-	-	-	
170	201	227	193	2,1	2,1	5,8	180	190	196	250	2	2	0,1	HJ 1034	0,94	11	21
	220	268	207	4	4	2,9	187	203	210	293	3	3	0,15	HJ 234 EC	1,65	12	20
	220	268	207	4	4	2,9	187	203	224	293	3	3	0,15	HJ 234 EC	1,65	12	20
	220	268	207	4	4	-	187	-	224	293	3	3	0,15	-	-	-	-
	-	270	205	4	4	4,2	187	200	208	293	3	3	0,2	-	-	-	-
	-	303	218	4	4	4,6	187	214	221	343	3	3	0,15	-	-	-	-
	236	-	318	4	4	4,6	187	313	323	343	3	3	0,15	-	-	-	-
	-	299	216	4	4	10	187	211	220	343	3	3	0,25	-	-	-	-
	238	299	216	4	4	10	187	211	242	343	3	3	0,25	-	-	-	-

¹⁾ Permissible axial displacement from normal position of one ring in relation to the other

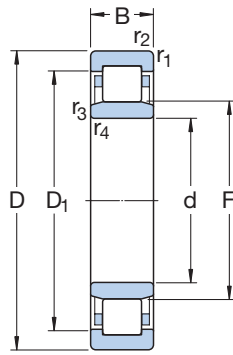

Type NU

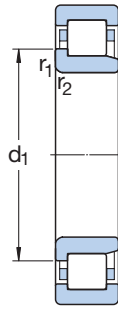

Type NJ

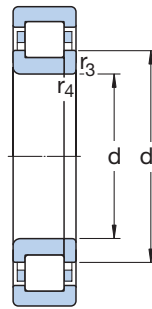

Type NUP

Principal dimensions			Basic load ratings		Fatigue load limit P _u	Speed ratings		Mass Bearing with standard cage	Designations Bearing with standard cage	Alternative standard cage design ¹⁾	
d	D	B	C	C ₀		Reference speed	Limiting speed				
mm			kN		kN	r/min		kg	–		
180	280	46	336	475	51	2 600	4 000	10,5	NU 1036 ML	M	
	320	52	720	850	88	2 200	3 200	19,5	NU 236 ECMA	–	
	320	52	720	850	88	2 200	3 200	20,2	NJ 236 ECMA	–	
	320	52	720	850	88	2 200	3 200	21,0	NUP 236 ECMA	–	
	320	86	1 100	1 430	146	2 200	3 200	31,5	NU 2236 ECMA	M	
	320	86	1 100	1 430	146	2 200	3 200	32,0	NJ 2236 ECMA	M	
	380	75	1 020	1 290	125	1 600	2 200	44,0	NU 336 ECM	–	
	380	126	1 610	2 240	220	1 600	2 800	71,5	NU 2336 ECMA	–	
	190	290	46	347	500	53	2 600	3 800	11,0	NU 1038 ML	–
		340	55	800	965	98	2 000	3 000	24,0	NU 238 ECMA	M
340		55	800	965	98	2 000	3 000	24,5	NJ 238 ECMA	M	
340		55	800	965	98	2 000	3 000	25,0	NUP 238 ECMA	M	
340		92	1 220	1 600	160	2 000	3 000	39,0	NU 2238 ECMA	–	
400		78	1 140	1 500	143	1 500	2 000	50,0	NU 338 ECM	–	
400		132	1 830	2 550	236	1 500	2 600	82,5	NU 2338 ECMA	–	
200		310	51	380	570	58,5	2 400	3 000	14,5	NU 1040 MA	M
	360	58	850	1 020	100	1 900	2 800	28,5	NU 240 ECMA	M	
	360	58	850	1 020	100	1 900	2 800	29,0	NJ 240 ECMA	M	
	360	58	850	1 020	100	1 900	2 800	29,5	NUP 240 ECMA	M	
	360	98	1 370	1 800	180	1 900	2 800	46,0	NU 2240 ECMA	–	
	420	80	1 230	1 630	150	1 400	2 400	56,0	NU 340 ECMA	–	
	420	138	1 980	2 800	255	1 400	2 400	97,0	NU 2340 ECMA	–	
	420	138	1 980	2 800	255	1 400	2 400	98,0	NJ 2340 ECMA	–	
	220	340	56	495	735	73,5	2 200	2 800	19,0	NU 1044 MA	M
		400	65	1 060	1 290	125	1 600	2 400	38,5	NU 244 ECMA	M
400		65	1 060	1 290	125	1 600	2 400	39,0	NJ 244 ECMA	M	
400		65	1 060	1 290	125	1 600	2 400	39,5	NUP 244 ECMA	M	
400		108	1 570	2 280	212	1 600	2 400	62,5	NU 2244 ECMA	–	
460		88	1 210	1 630	150	1 500	1 700	72,5	NU 344 M	–	
460		88	1 210	1 630	150	1 500	1 700	73,5	NJ 344 M	–	
460		145	2 380	3 450	310	1 300	2 200	120	NU 2344 ECMA	–	

The designations of SKF Explorer class bearings are printed in blue

¹⁾ When ordering bearings with an alternative standard cage the suffix of the standard cage has to be replaced by the suffix of the cage in question. e.g. NU 2236 ECMA becomes NU 2236 ECM

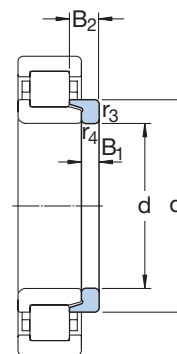
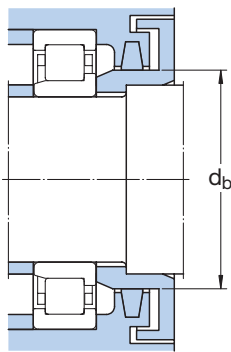
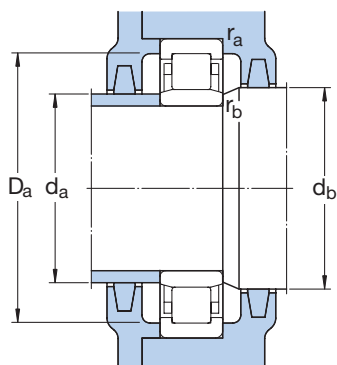

Angle ring



Dimensions							Abutment and fillet dimensions						Calculation factor k_r	Angle ring Designation	Mass	Dimensions		
d	d_1	D_1	F	$r_{1,2}$ min	$r_{3,4}$ min	$s^{1)}$	d_a min	d_a max	d_b min	D_a max	r_a max	r_b max				B_1	B_2	
mm							mm						-	-	kg	mm		
180	-	244	205	2,1	2,1	6,1	190	202	208	270	2	2	0,1	-	-	-	-	
	230	279	217	4	4	2,9	197	213	220	303	3	3	0,15	HJ 236 EC	1,70	12	20	
	230	279	217	4	4	2,9	197	213	234	303	3	3	0,15	HJ 236 EC	1,70	12	20	
	230	279	217	4	4	-	197	-	234	303	3	3	0,15	-	-	-	-	
	-	280	215	4	4	4,2	197	210	218	303	3	3	0,2	-	-	-	-	
	229	280	215	4	4	4,2	197	210	233	303	3	3	0,2	-	-	-	-	
	-	319	227	4	4	5	197	223	230	363	3	3	0,15	-	-	-	-	
	-	320	227	4	4	10,5	197	223	230	363	3	3	0,25	-	-	-	-	
	190	-	254	215	2,1	2,1	6,1	200	212	218	280	2	2	0,1	-	-	-	-
		244	295	230	4	4	3	207	226	234	323	3	3	0,15	HJ 238 EC	2,10	13	21,5
244		295	230	4	4	3	207	226	248	323	3	3	0,15	HJ 238 EC	2,10	13	21,5	
244		295	230	4	4	-	207	-	248	323	3	3	0,15	-	-	-	-	
-		297	228	4	4	5	207	222	232	323	3	3	0,2	-	-	-	-	
264		338	245	5	5	4,3	210	240	249	380	4	4	0,15	HJ 338 EC	4,30	18	29	
-		341	240	5	5	9,5	210	235	244	380	4	4	0,25	-	-	-	-	
200		239	269	229	2,1	2,1	7	210	225	233	299	2	2	0,1	HJ 1040	1,65	13	25,5
		258	312	243	4	4	2,6	217	239	247	343	3	3	0,15	HJ 240 EC	2,55	14	23
		258	312	243	4	4	2,6	217	239	262	343	3	3	0,15	HJ 240 EC	2,55	14	23
	258	312	243	4	4	-	217	-	262	343	3	3	0,15	-	-	-	-	
	-	313	241	4	4	5,1	217	235	245	343	3	3	0,2	-	-	-	-	
	-	337	260	5	5	4	220	253	264	400	4	4	0,15	-	-	-	-	
	-	350	247	5	5	9,4	220	241	251	400	4	4	0,25	-	-	-	-	
	278	350	247	5	5	9,4	220	241	280	400	4	4	0,25	-	-	-	-	
	220	262	297	250	3	3	7,5	233	246	254	327	2,5	2,5	0,1	HJ 1044	2,10	14	27
		-	344	268	4	4	2,3	237	264	270	383	3	3	0,15	-	-	-	-
284		344	268	4	4	2,3	237	264	288	383	3	3	0,15	-	-	-	-	
284		344	268	4	4	-	237	-	288	383	3	3	0,15	-	-	-	-	
-		349	259	4	4	7,9	237	255	264	383	3	3	0,2	-	-	-	-	
-		371	284	5	5	5,2	240	277	288	440	4	4	0,15	-	-	-	-	
307		371	284	5	5	5,2	240	277	311	440	4	4	0,15	-	-	-	-	
-		384	277	5	5	10,4	240	268	280	440	4	4	0,25	-	-	-	-	

¹⁾ Permissible axial displacement from normal position of one ring in relation to the other

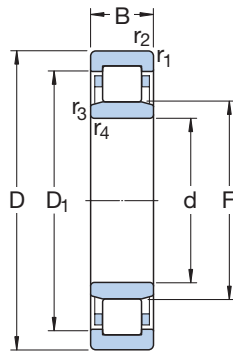

Type NU



Type NJ

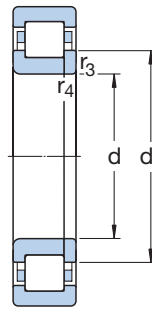

Type NUP

Principal dimensions			Basic load ratings		Fatigue load limit P _u	Speed ratings		Mass	Designation	
d	D	B	dynamic	static		Reference speed	Limiting speed			
mm			kN		kN	r/min		kg	–	
240	360	56	523	800	78	2 000	2 600	20,0	NU 1048 MA	
	440	72	952	1 370	129	1 600	2 200	51,5	NU 248 MA	
	440	72	952	1 370	129	1 600	2 200	52,5	NJ 248 MA	
240	440	72	952	1 370	129	1 600	2 200	53,5	NUP 248 MA	
	440	120	1 450	2 360	216	1 500	2 200	84,0	NU 2248 MA	
	440	120	1 450	2 360	216	1 500	2 200	85,0	NJ 2248 MA	
240	500	95	1 450	2 000	180	1 300	1 600	94,5	NU 348 M	
	500	95	1 450	2 000	180	1 300	2 000	98,5	NJ 348 MA	
	500	155	2 600	3 650	320	1 200	2 000	155	NU 2348 ECMA	
260	400	65	627	965	96,5	1 800	2 400	29,5	NU 1052 MA	
	480	80	1 170	1 700	156	1 400	2 000	68,5	NU 252 MA	
	480	80	1 170	1 700	156	1 400	2 000	70,0	NJ 252 MA	
260	480	80	1 170	1 700	156	1 400	2 000	72,0	NUP 252 MA	
	480	130	1 790	3 000	265	1 300	2 000	110	NU 2252 MA	
	480	130	1 790	3 000	265	1 300	2 000	112	NJ 2252 MA	
260	540	102	1 940	2 700	236	1 100	1 800	125	NU 352 ECMA	
	280	420	65	660	1 060	102	1 700	2 200	32,5	NU 1056 MA
	500	80	1 140	1 700	153	1 400	1 900	71,5	NU 256 MA	
280	500	80	1 140	1 700	153	1 400	1 900	73,0	NJ 256 MA	
	500	130	2 200	3 250	285	1 200	1 900	115	NU 2256 ECMA	
	580	175	2 700	4 300	365	1 000	1 700	230	NU 2356 MA	
300	460	74	858	1 370	129	1 500	2 000	46,5	NU 1060 MA	
	460	74	858	1 370	129	1 500	2 000	47,0	NJ 1060 MA	
	540	85	1 420	2 120	183	1 300	1 800	89,5	NU 260 MA	
300	540	140	2 090	3 450	300	1 200	1 800	145	NU 2260 MA	
	480	74	880	1 430	132	1 400	1 900	48,5	NU 1064 MA	
	480	74	880	1 430	132	1 400	1 900	49,0	NJ 1064 MA	
320	580	92	1 610	2 450	204	1 200	1 600	115	NU 264 MA	
	580	150	3 190	5 000	415	1 000	1 600	180	NU 2264 ECMA	
	520	82	1 080	1 760	156	1 300	1 700	65,0	NU 1068 MA	
340	520	82	1 080	1 760	156	1 300	1 700	68,0	NJ 1068 MA	
	620	165	2 640	4 500	365	1 000	1 500	220	NU 2268 MA	

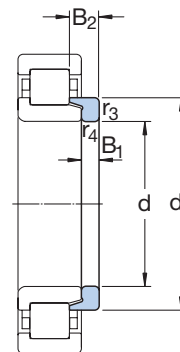
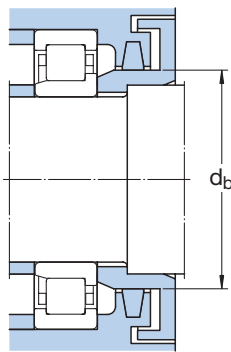
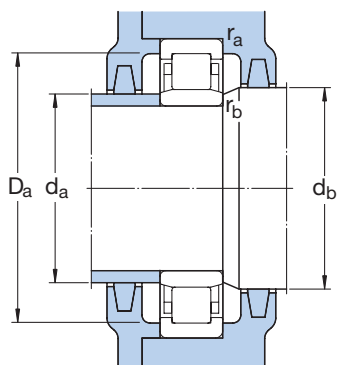

Angle ring



Dimensions							Abutment and fillet dimensions						Calculation factor k_r	Angle ring Designation	Mass	Dimensions		
d	d ₁	D ₁	F	r _{1,2} min	r _{3,4} min	s ¹⁾	d _a min	d _a max	d _b min	D _a max	r _a max	r _b max				B ₁	B ₂	
mm							mm						-	-	kg	mm		
240	282	317	270	3	3	7,5	253	266	274	347	2,5	2,5	0,1	HJ 1048	2,25	14	27	
	-	365	295	4	4	3,4	257	288	299	423	3	3	0,15	-				
	313	365	295	4	4	3,4	257	288	317	423	3	3	0,15	-				
	313	365	295	4	4	-	257	-	317	423	3	3	0,15	-				
	-	365	295	4	4	4,3	257	284	299	423	3	3	0,2	-				
	313	365	295	4	4	4,3	257	284	317	423	3	3	0,2	-				
	-	365	295	5	5	5,6	260	302	314	480	4	4	0,15	HJ 348	8,90	22	39,5	
	335	401	310	5	5	5,6	260	302	339	480	4	4	0,15	HJ 348	8,90	22	39,5	
	-	426	299	5	5	10,3	260	295	305	480	4	4	0,25	-				
	260	309	349	296	4	4	8	276	291	300	384	3	3	0,1	HJ 1052	3,30	16	31,5
		340	397	320	5	5	3,4	280	313	324	460	4	4	0,15	HJ 252	6,20	18	33
		340	397	320	5	5	3,4	280	313	344	460	4	4	0,15	HJ 252	6,20	18	33
340		397	320	5	5	-	280	-	344	460	4	4	0,15	-				
-		397	320	5	5	4,3	280	309	324	460	4	4	0,2	-				
340		397	320	5	5	4,3	280	309	344	460	4	4	0,2	-				
-		455	337	6	6	4,2	286	330	341	514	5	5	0,15	-				
280		329	369	316	4	4	8	295	311	320	405	3	3	0,1	HJ 1056	3,55	16	31,5
		-	417	340	5	5	3,8	300	333	344	480	4	4	0,15	-			
		360	417	340	5	5	3,8	300	333	364	480	4	4	0,15	-			
	350	433	327	5	5	10,2	300	320	331	480	4	4	0,2	HJ 2256 EC	6,75	18	38	
	-	467	362	6	6	6,6	306	347	366	554	5	5	0,25	-				
	300	356	402	340	4	4	9,7	317	335	344	443	3	3	0,1	HJ 1060	5,30	19	36
356		402	340	4	4	9,7	317	335	360	443	3	3	0,1	HJ 1060	5,30	19	36	
-		451	364	5	5	4,8	320	358	368	520	4	4	0,15	-				
-		451	364	5	5	5,6	320	352	368	520	4	4	0,2	-				
320		376	422	360	4	4	9,7	335	355	364	465	3	3	0,1	HJ 1064	5,65	19	36
		376	422	360	4	4	9,7	335	355	380	465	3	3	0,1	HJ 1064	5,65	19	36
	-	485	390	5	5	5,3	340	383	394	560	4	4	0,15	-				
	-	507	380	5	5	5,9	340	377	384	560	4	4	0,2	-				
340	403	455	385	5	5	6,5	358	380	389	502	4	4	0,1	HJ 1068	7,40	21	39,5	
	403	455	385	5	5	6,5	358	380	408	502	4	4	0,1	HJ 1068	7,40	21	39,5	
	-	515	416	6	6	8	366	401	421	594	5	5	0,2	-				

¹⁾ Permissible axial displacement from normal position of one ring in relation to the other

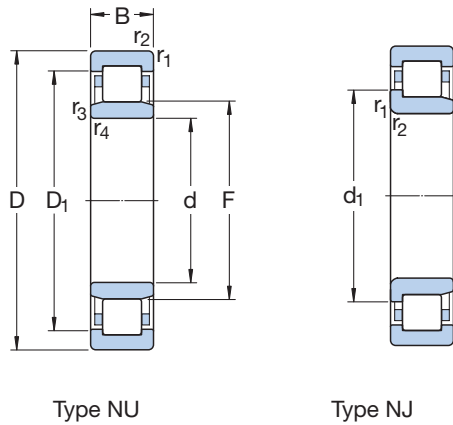

Type NU

Type NJ

Principal dimensions			Basic load ratings		Fatigue load limit P _u	Speed ratings		Mass	Designation
d	D	B	dynamic	static		Reference speed	Limiting speed		
mm			kN		kN	r/min		kg	–
360	540	82	1 100	1 830	163	1 300	1 600	67,5	NU 1072 MA
	650	170	2 920	4 900	400	950	1 400	250	NU 2272 MA
380	560	82	1 140	1 930	170	1 200	1 600	71,0	NU 1076 MA
	560	82	1 140	1 930	170	1 200	1 600	73,0	NJ 1076 MA
	680	175	3 140	5 500	440	900	1 600	275	NU 2276 ECMA
400	600	90	1 380	2 320	204	1 100	1 500	92,5	NU 1080 MA
420	620	90	1 420	2 450	212	1 100	1 400	96,0	NU 1084 MA
440	650	94	1 510	2 650	212	1 000	1 300	105	NU 1088 MA
460	680	100	1 650	2 850	224	950	1 200	115	NU 1092 MA
	830	165	4 180	6 800	510	750	1 100	415	NU 1292 MA
	830	212	5 120	8 650	655	700	1 100	530	NU 2292 MA
480	700	100	1 680	3 000	232	900	1 200	130	NU 1096 MA
500	720	100	1 720	3 100	236	900	1 100	135	NU 10/500 MA
	920	185	5 280	8 500	620	670	950	585	NU 12/500 MA
530	780	112	2 290	4 050	305	800	1 000	190	NU 10/530 MA
	780	145	3 740	7 350	550	670	1 000	255	NU 20/530 ECMA
560	820	115	2 330	4 250	310	750	1 000	210	NU 10/560 MA
	820	150	3 800	7 650	560	630	1 000	290	NU 20/560 ECMA
	1 030	206	7 210	11 200	780	560	800	805	NU 12/560 MA
600	870	118	2 750	5 100	365	700	900	245	NU 10/600 N2MA
	870	155	4 180	8 000	570	600	900	325	NU 20/600 ECMA
	1 090	155	5 610	9 800	670	480	850	710	NU 2/600 ECMA/HB1
630	920	128	3 410	6 200	430	630	1 000	285	NU 10/630 ECN2MA
	920	170	4 730	9 500	670	560	850	400	NU 20/630 ECMA
	1 150	230	8 580	13 700	915	450	700	1 100	NU 12/630 ECMA
670	980	136	3 740	6 800	465	530	800	350	NU 10/670 ECMA
	980	180	5 390	11 000	750	500	800	480	NU 20/670 ECMA
710	1 030	140	4 680	8 500	570	500	750	415	NU 10/710 ECN2MA
	1 030	185	5 940	12 000	815	480	700	540	NU 20/710 ECMA
750	1 090	150	4 730	8 800	585	430	670	490	NU 10/750 ECN2MA
	1 090	195	7 040	14 600	980	430	670	635	NU 20/750 ECMA
800	1 150	200	7 040	14 600	950	400	630	715	NU 20/800 ECMA

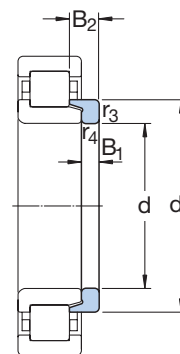
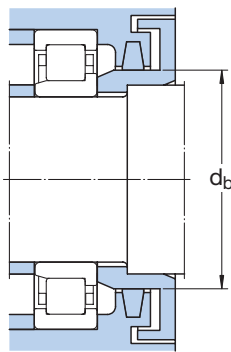
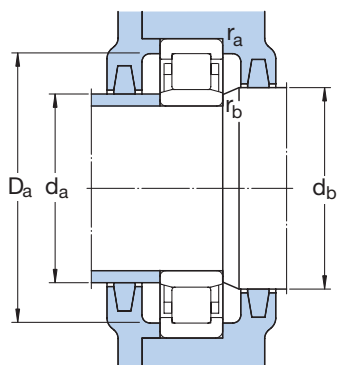

Angle ring

3

Dimensions							Abutment and fillet dimensions						Calculation factor k_r	Angle ring Designation	Mass	Dimensions		
d	d ₁	D ₁	F	r _{1,2}	r _{3,4}	s ¹⁾	d _a	d _a	d _b	D _a	r _a	r _b				B ₁	B ₂	
mm							mm						-	-	kg	mm		
360	423	475	405	5	5	6,5	378	400	410	522	4	4	0,1	HJ 1072	7,75	21	39,5	
	-	542	437	6	6	16,7	386	428	442	624	5	5						0,2
380	443	495	425	5	5	10,8	398	420	430	542	4	4	0,1	HJ 1076	8,25	21	39,5	
	443	495	425	5	5	10,8	398	420	448	542	4	4	0,1					HJ 1076
	-	595	451	6	6	8,3	406	447	455	654	5	5	0,2					
400	470	527	450	5	5	14	418	446	455	582	4	4	0,1	HJ 1080	9,75	23	43	
420	490	547	470	5	5	14	438	466	475	602	4	4	0,1	HJ 1084	10,0	23	43	
440	512	574	493	6	6	14,7	463	488	498	627	5	5	0,1	HJ 1088	11,5	24	45	
460	537	600	516	6	6	15,9	483	511	521	657	5	5	0,1	HJ 1092	14,0	25	48	
	-	715	554	7,5	7,5	6,4	492	542	559	798	6	6	0,14					-
	-	706	554	7,5	7,5	16,5	492	542	559	798	6	6	0,2					-
480	557	620	536	6	6	15,9	503	531	541	677	5	5	0,1	HJ 1096	14,5	25	48	
500	577	640	556	6	6	11,2	523	550	561	697	5	5	0,1	HJ 10/500	15,0	25	48	
	-	728	576	7,5	7,5	14,5	532	564	581	798	6	6	0,21					-
530	-	692	593	6	6	10,4	553	585	598	757	5	5	0,1	-				
	-	704	591	6	6	6,8	553	587	596	757	5	5	0,14					
560	648	726	625	6	6	12,3	583	617	630	797	5	5	0,1	HJ 10/560	21,0	27,5	53	
	-	726	625	6	6	12,3	583	617	630	797	5	5	0,1					-
	-	741	626	6	6	6,7	583	616	631	797	5	5	0,14					-
600	695	779	667	6	6	14	623	658	672	847	5	5	0,1	HJ 10/600	27,5	31	55	
	-	793	661	6	6	6,1	623	652	667	847	5	5	0,14					-
	-	935	749	9,5	9,5	3	640	743	755	1 050	8	8	0,17					-
630	-	837	702	7,5	7,5	6,2	658	691	706	892	6	6	0,1	-				
	-	832	699	7,5	7,5	8,7	658	690	705	892	6	6	0,14					-
	-	1 005	751	12	12	13,5	678	735	757	1 102	10	10	0,17					-
670	-	891	747	7,5	7,5	7,9	698	736	753	952	6	6	0,1	-				
	-	890	746	7,5	7,5	7	698	736	752	952	6	6	0,14					
710	-	939	778	7,5	7,5	8	738	769	783	1 002	6	6	0,1	-				
	-	939	787	7,5	7,5	10	738	774	793	1 002	6	6	0,14					
750	-	993	832	7,5	7,5	3	778	823	838	1 062	6	6	0,1	-				
	-	993	832	7,5	7,5	2	778	823	838	1 062	6	6	0,14					
800	-	1 051	882	7,5	7,5	2	828	868	888	1 122	6	6	0,14	-				

¹⁾ Permissible axial displacement from normal position of one ring in relation to the other

Other SKF cylindrical roller bearings

Single row cylindrical roller bearings with a cage listed in the product table starting on **page 32** constitute the basic SKF assortment and are only part of the total range of SKF cylindrical roller bearings. Other products belonging to the range and which are briefly described in the following are

- precision cylindrical roller bearings,
- full complement cylindrical roller bearings,
- backing bearings for cluster mills,
- bearings for rolling mills, and
- cylindrical roller thrust bearings.

The SKF manufacturing programme also covers electrically insulating cylindrical roller bearings for electric motors and other electrical machines: the INSOCOAT® bearings. Other items include various designs of support rollers and cam followers, indexing rollers for sintering and pelletising plants, bearings for crane wheels and pulleys, special bearings for the automotive industry, cylindrical roller bearing units for traction motors and complete railway axleboxes.

Precision cylindrical roller bearings

Where characteristics such as high radial load carrying capacity, high stiffness and high speed capability are required at the same time as high running accuracy and compact form, SKF precision cylindrical roller bearings are an obvious choice.

They are available mainly as double row bearings and are primarily used where heavy radial loads have to be accommodated without excessive elastic deformation. In applications where high speed capability is required, but heavy radial load capability is not, single row precision cylindrical roller bearings can be used. These bearings are available as all-steel bearings as well as hybrid bearings with ceramic rollers.

Details of these precision cylindrical roller bearings can be found in the SKF catalogue "High-precision bearings".



Full complement cylindrical roller bearings

Heavy radial loads, limited space, relatively low speeds and, where possible, oil lubrication are excellent conditions for SKF full complement cylindrical roller bearings and where they have proven their exceptional value. Considerable reliability reserves are derived from the special internal design and the logarithmic roller profile.

The SKF standard range comprises single and double row full complement cylindrical roller bearings in several designs and dimension series.

Backing bearings for cluster mills

The operating conditions in a multi-roll cold rolling mill or cluster mill as they are sometimes called, involve high specific rolling forces and relatively high roll speeds. Additionally, the demands on the finished product with regard to flatness and surface quality are extremely high. To achieve high running accuracy and the ability to accommodate heavy loads are key operational parameters for the back-up rolls. SKF backing bearings meet these demands as they have extremely narrow tolerances for cross-sectional height and radial runout.

Detailed information can be found in the SKF Interactive Engineering Catalogue, available on CD-ROM or online at www.skf.com.

Bearings for rolling mills

The operating conditions that are typical for rolling mill bearing applications place special demands on the bearings. As a rule special bearings that differ from standardized bearings in design and execution are required, including multi-row cylindrical roller bearings. These bearings are preferred when rolling speeds are high, because of their low friction, when compared with other roller bearing designs. Their low cross section means that the roll necks can be relatively large with respect to the roll diameter. SKF multi-row cylindrical roller bearings are designed so that they incorporate a large number of rollers and can therefore carry very heavy loads. However, the bearings cannot accommodate any axial loads and as a result, a separate thrust bearing must be used.

Detailed information on SKF cylindrical roller bearings for rolling mills, including the multi-row bearings, can be found in the SKF Interactive Engineering Catalogue, available on CD-ROM or online at www.skf.com.

Cylindrical roller thrust bearings

SKF cylindrical roller thrust bearings are an excellent choice for stiff bearing arrangements that are relatively compact in the axial direction and where heavy axial loads have to be accommodated. The bearings are relatively insensitive to shock loads. Complete bearings comprise a cylindrical roller and cage thrust assembly, a shaft washer and a housing washer. The components are available separately or in various combinations.

The basic SKF range comprises the single direction bearings in the 811 and 812 series as well as the particularly robust bearings in the 874, 893 and 894 series. For applications where axial loads act in both directions, components from bearings in the 811 series together with intermediate washers can be combined to form double direction bearings.

Detailed information on SKF cylindrical roller thrust bearings can be found in the SKF General Catalogue or in the SKF Interactive Engineering Catalogue, available on CD-ROM or online at www.skf.com.



SKF - The knowledge engineering company

The business of the SKF Group consists of the design, manufacture and marketing of the world's leading brand of rolling bearings, with a global leadership position in complementary products such as radial seals. SKF also holds an increasingly important position in the market for linear motion products, high precision aerospace bearings, machine tool spindles, as well as plant maintenance services and is an established producer of high-quality bearing steel.

The SKF Group maintains specialized businesses to meet the needs of the global marketplace. SKF supports specific market segments with ongoing research and development efforts that have led to a growing number of innovations, new standards and new products.

SKF Group has global ISO 14001 environmental certification. Individual divisions have been approved for quality certification in accordance with either ISO 9000 or appropriate industry specific standards.

Some 80 manufacturing sites worldwide and sales companies in 70 countries make SKF a truly international corporation. In addition, our 7 000 distributor and dealer partners around the world, e-business marketplace and global distribution system put SKF close to customers for the supply of both products and services. In essence, SKF solutions are available wherever and whenever our customers need them.

Overall, the SKF brand now stands for more than ever before. It stands for the knowledge engineering company ready to serve you with world-class product competences, intellectual resources and the vision to help you succeed.



Harnessing wind power

The growing industry of wind-generated electric power provides an environmentally compatible source of electricity. SKF is working closely with global industry leaders to develop efficient and trouble-free turbines, using SKF knowledge to provide highly specialized bearings and condition monitoring systems to extend equipment life in the extreme and often remote environments of wind farms.

Developing a cleaner cleaner

The electric motor and its bearings are the heart of many household appliances. SKF works closely with appliance manufacturers to improve their product performance, cut costs and reduce weight. A recent



example produced a new generation of vacuum cleaners with substantially more suction. SKF's knowledge in small bearing technology is also applied to manufacturers of power tools and office equipment.



Delivering asset efficiency optimization

To optimize efficiency and boost productivity, many industrial facilities outsource some or all of their maintenance services to SKF, often with guaranteed performance contracts. Through the specialized capabilities and knowledge available from

SKF Reliability Systems, SKF provides a comprehensive range of asset efficiency services, from maintenance strategies and engineering assistance, to operator-driven reliability and machine maintenance programs.



Creating a new “cold remedy”

In the frigid winters of northern China, sub-zero temperatures can cause rail car wheel assemblies and their bearings to seize due to lubrication starvation. SKF created a new family of synthetic lubricants formulated to retain their lubrication viscosity even at these extreme bearing temperatures. SKF’s knowledge of lubricants and friction are unmatched throughout the world.



Evolving by-wire technology

SKF has unique expertise and knowledge in fast growing by-wire technology, from fly-by-wire, to drive-by-wire, to work-by-wire. SKF pioneered practical fly-by-wire technology and is a close working partner with all aerospace industry leaders. As an example, virtually all aircraft of the Airbus design use SKF by-wire systems for cockpit flight control. SKF is also a leader in automotive drive-by-wire,

having jointly developed the revolutionary Filo and Novanta concept cars which employ SKF mechatronics for steering and braking. Further by-wire development has led SKF to produce an all-electric forklift truck which uses mechatronics rather than hydraulics for all controls.

Planning for sustainable growth

By their very nature, bearings make a positive contribution to the natural environment. Reduced friction enables machinery to operate more efficiently, consume less power and require less lubrication. SKF is continually raising the performance bar, enabling new generations of high-efficiency products and equipment. With an eye to the future, SKF’s global policies and manufacturing techniques are planned and implemented to help protect and preserve the earth’s limited natural resources. We remain committed to sustainable, environmentally responsible growth.



Maintaining a 320 km/h R&D lab

In addition to SKF’s renowned research and development facilities in Europe and the United States, Formula One car racing provides a unique environment for SKF to push the limits of bearing technology. For over 50 years, SKF products, engineering and knowledge have helped make

Scuderia Ferrari a formidable force in F1 racing. (The average racing Ferrari utilizes more than 150 SKF components.) Lessons learned here are applied to the products we provide to automakers and the after-market worldwide.

® SKF and INSOCOAT are registered trademarks of the SKF Group.
™ Total Shaft Solutions and Asset Efficiency Optimization are trademarks of the SKF Group.

© Copyright SKF 2004

The contents of this publication are the copyright of the publisher and may not be reproduced (even extracts) unless permission is granted. Every care has been taken to ensure the accuracy of the information contained in this publication but no liability can be accepted for any loss or damage whether direct, indirect or consequential arising out of the use of the information contained herein.

Publication **5108 E** • May 2004

Printed in Sweden on environmentally friendly, chlorine-free paper (Multiart Silk) by Strokirk-Landströms AB.

www.skf.com