

Telescopic pillars

TMS10 EASY, TMS00 MECHANICAL

Description

The TMS lifting pillars consist of 3 telescopic aluminum profiles which are mounted on 2 circulating ball rollers. The design is constructed in such a way that an optimal stroke/retracted length ratio is achieved. The drives work on push load. For transport purposes, the drive can hold a load of max. 1 000 N tensile force. Two versions are available: TMS10 EASY and TMS00 MECHANICAL.

TMS10 EASY

Two (2) DC voltage motors with worm gears are used as drives which have a rotation motion through a spindle nut system which is converted to a linear motion. The linear drive is self-locking in each position. Two (2) safety limit switches are used as end position limit. The power supply and control occurs through a Magnetic BCU, VCU, or SCU control unit and control elements developed especially for it. The drive is protected by this control unit from overload.

TMS00 MECHANICAL

In order to offer the most open system possible the MECHANICAL type has no drive motor installed. As a result optimal adaptation to existing drive systems and control units is ensured. Via a double worm gear 2 spindles are run in order to

implement the lift motion. The spindle systems are self-locking, which offers a high level of security in the case of motor failure.

Electrical connection

Electrical connection to the control unit in the TMS10 Easy type works through the established Magnetic DIN8 plug system.

Installation

Attachment of the TMS drives to the construction elements to be moved is on the upper and lower side of the pillars via 8 through-holes. There are 8 screws of the type M12-8.8 to be used, which should be screwed on with a torque of 70 Nm. The screw reach into the assembly parts must be at least 25 mm. During commissioning and installation the information in the technical instructions must be followed. All applications should be protected against platform hazards.

Please keep in mind:

- If no mounting plates are used, the supporting plates should support the TMS above and below.
- If the user's own mounting plates are used, they have to be manufactured in accordance with the dimensional drawing. (min. plate strength: 8 mm)



- With non-central loads, the lift force diagram must be followed or discussed with the factory.
- Between the profiles and the mounting plates and in the drive area there is danger of catching body parts.

Maintenance

The drive is maintenance-free with compliance with the technical instructions for the specified lifetime of 10 years or 16 000 m running distance.

| Technical data: | Unit | TMS10 EASY | TMS00 MECHANICAL |
|------------------------------------|--------|---|---|
| Version | - | Stand-alone | Stand-alone |
| Push force (max.) | N | 4 000 | 4 000 |
| Torque | Nm | 3 500 | 3 500 |
| Operating mode | - | Intermittent 10 %; 1 min ON/9 min OFF | Intermittent 10 %; 1 min ON/9 min OFF |
| Speed | mm/s | 16 to 28 | 20 at 6 000 RPM |
| Stroke (in increments of 100) | mm | 300 to 700 | 300 to 700 |
| Retracted length | mm | 326 to 526 | 326 to 526 |
| Voltage | V/Hz | 24 DC | - |
| Current input | A (DC) | 2x6 | - |
| Torque drive shaft | Nm | - | max 0,9 |
| Protective system/protection class | - | SELV | - |
| Weight | kg | 300 mm stroke: 64 400 mm stroke: 70 500 mm stroke: 75 600 mm stroke: 80 700 mm stroke: 85 | 300 mm stroke: 64 400 mm stroke: 70 500 mm stroke: 75 600 mm stroke: 80 700 mm stroke: 85 |



Telescopic pillars TMS10 EASY, TMS00 MECHANICAL

Characteristics TMS10 EASY

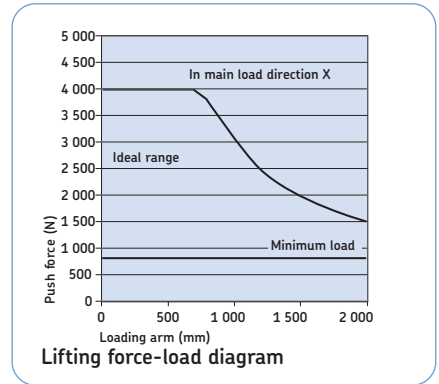
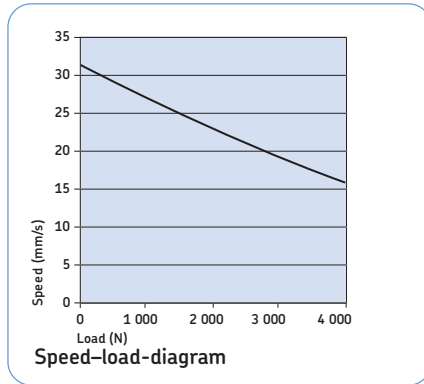
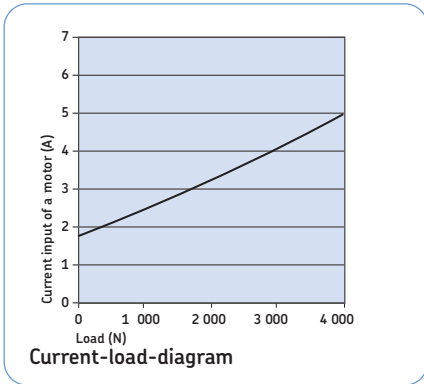

Characteristics TMS00 MECHANICAL

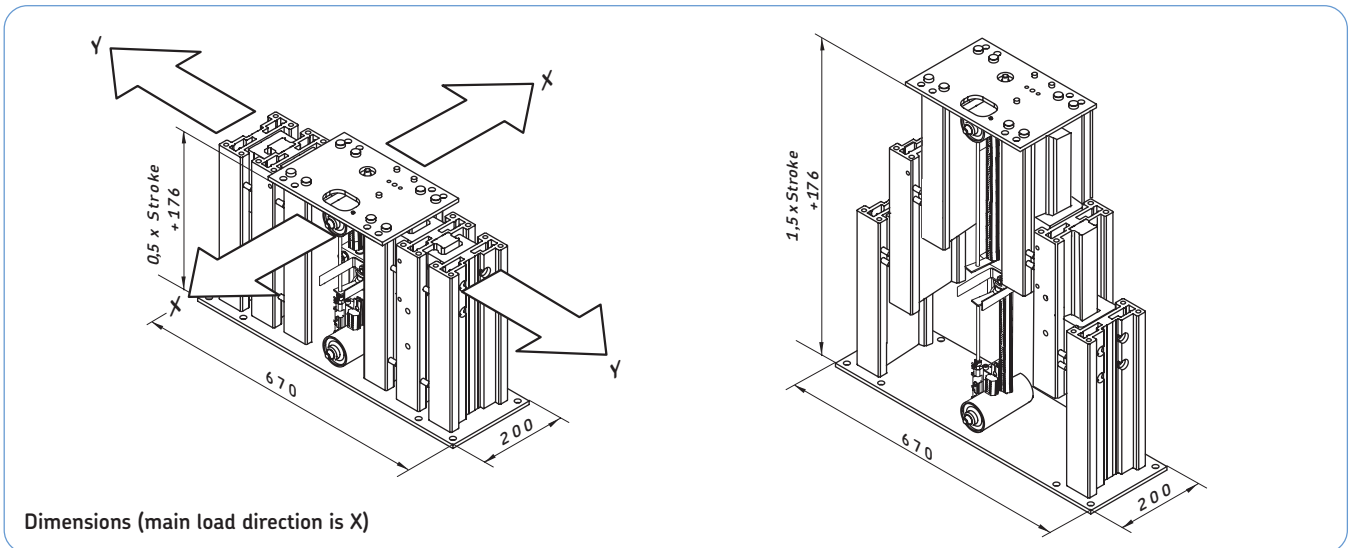
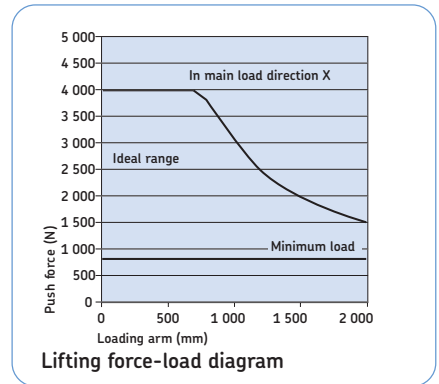
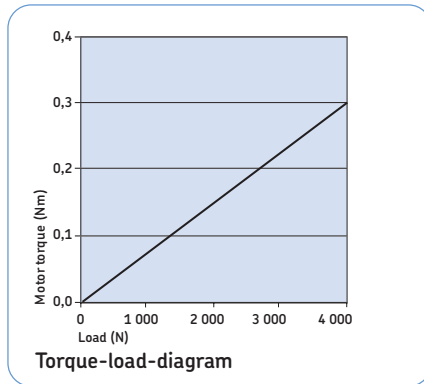
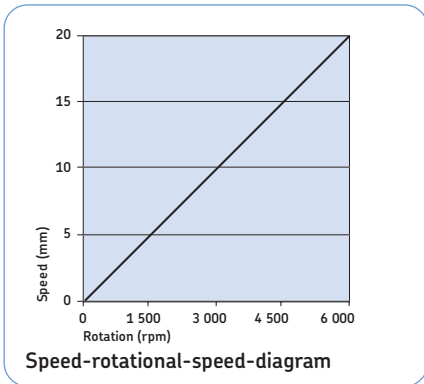

Further information is available on our datasheets:
 Control unit Magtronic BCU L5328,2960EN / VCU L5328,2965EN / SCU L5328,2970EN
 and in the technical instructions L5312,4100EN

Magnetic Elektromotoren AG
 CH-4410 Liestal, Switzerland
 Tel +41 61 925 4111, Fax +41 61 921 3704
 E-mail magnetic.switzerland@skf.com

© SKF and Magnetic are registered trademarks of the SKF Group.
 © SKF Group 2007.
 The contents of this publication are the copyright of the publisher and may not be reproduced (even extracts) unless prior written permission is granted. Every care has been taken to ensure the accuracy of the information contained in this publication but no liability can be accepted for any loss or damage whether direct, indirect or consequential arising out of the use of the information contained herein.



Publication L5322,4100EN.0/07.01